



OX®

**BORN IN
AUSTRALIA.
RAISED IN
AUSTRALIA**

**THE OX BOOK
EDITION 5**

oxtools.com



Our story

OX Group is a world leading manufacturer of hand tools, diamond tools and safety products.

Developed and proven in Australia over the past 40 years, our tools are recognised as tough, dynamic and dependable across the globe.

As manufacturer of professional tools we sell direct to the merchants, providing them with excellent service, innovative merchandising solutions and a very powerful brand.

FOLLOW US...

 [OXGroupInternationalPtyLtd](#)

 [OXGroupInternationalPtyLtd](#)

Issue Date: May 2016

Subject to availability and OX Group International terms and conditions of sale.
All prices exclude GST. E & OE.

17 offices, 8 countries, one **OX**



Australia
UK
New Zealand

USA
Canada
The Netherlands

Sweden
Spain

Call for your dedicated Account Manager...

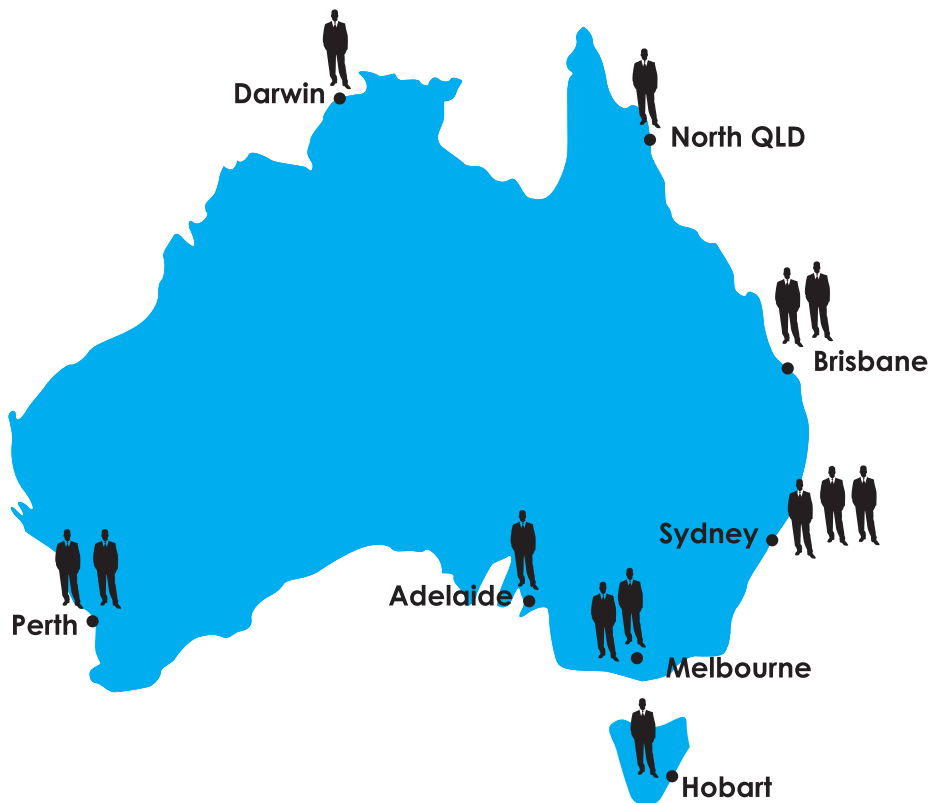

How to become an OX Re-Seller

The **OX** Advantage...

1. Signing up

Becoming an OX re-seller is simple. Schedule a meeting with one of our dynamic account managers and they will discuss our program, extensive product range and how we can help you grow your sales and increase your profits. Your account manager will suggest a planogram specifically suited to your store.

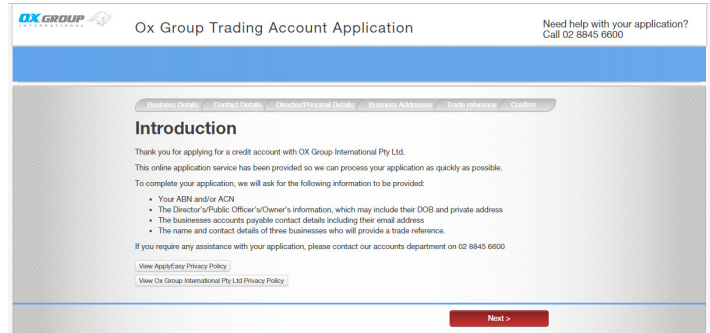

2. Starting the program

Once your account application is approved, you may begin ordering. Our customer for life culture is woven into our DNA and we'll support your store with staff training when needed, on site service and support.





3. Customer Service

OX Group's highly motivated Customer Service Team is dedicated to providing you with information, solutions and a fast response.

Their expertise covers a wide range of areas including product information & enquires, ordering, price & availability and order tracking.

Call our Customer Service Hotline Monday - Friday, 8am - 7pm AEST

PHONE		02 8845 6600
FAX		02 8845 6699
EMAIL		sales@oxgroup.com.au

4. Shipping

OX Group International has built up a reputation for operational excellence with an exceptionally high stock level and efficient fulfilment and dispatch system. This allows us to achieve a 98% fill rate.

Orders received by 12.00pm AEST are dispatched the same day.

Our minimum order value for F.I.S. is \$250.00 net Australian wide.



Sydney Distribution Warehouse



Perth Distribution Warehouse

5. Returns

Sale or return policy

No sale – No risk, No dead stock

If you cannot sell a mainstream [OX product](#) within 3 months of purchase, simply return it in a suitable condition for a full refund.



Whatever the level of merchandising support you need, we have the answer!

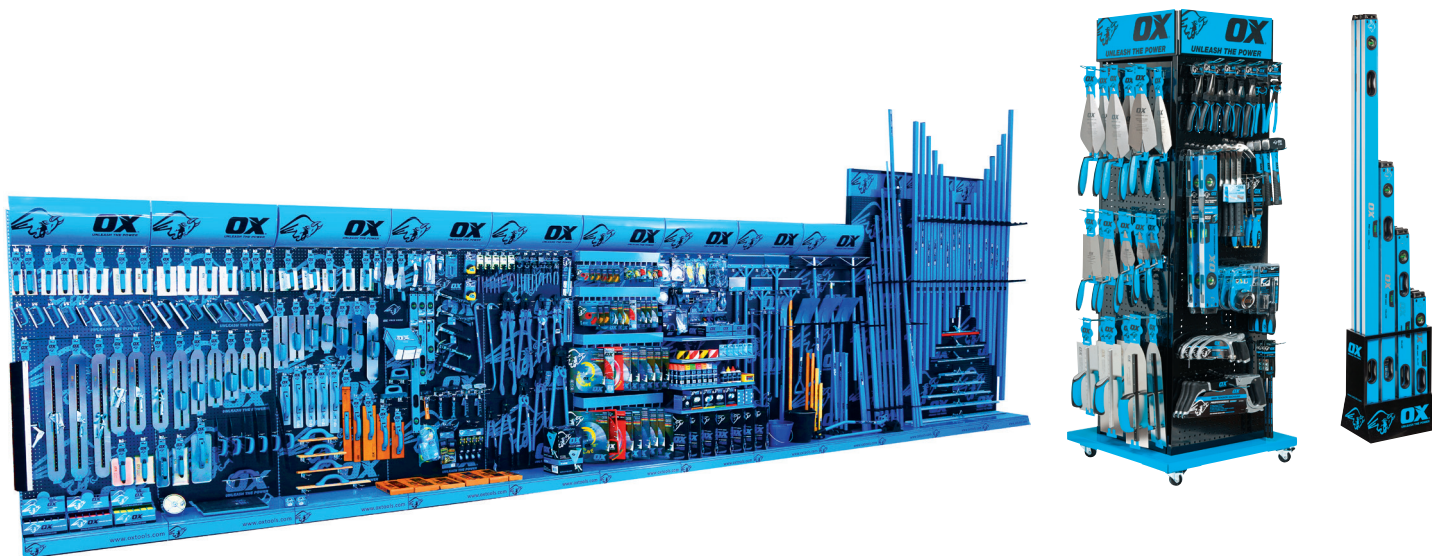

Introducing the new OX TUFF CLUB... driving Tradies into your store!



The OX Tuff Club is increasing brand awareness, loyalty and driving tradies into your store. Tradies get exclusive access to the latest news, products and promotions.

oxtuffclub.com.au

OX website - oxtools.com

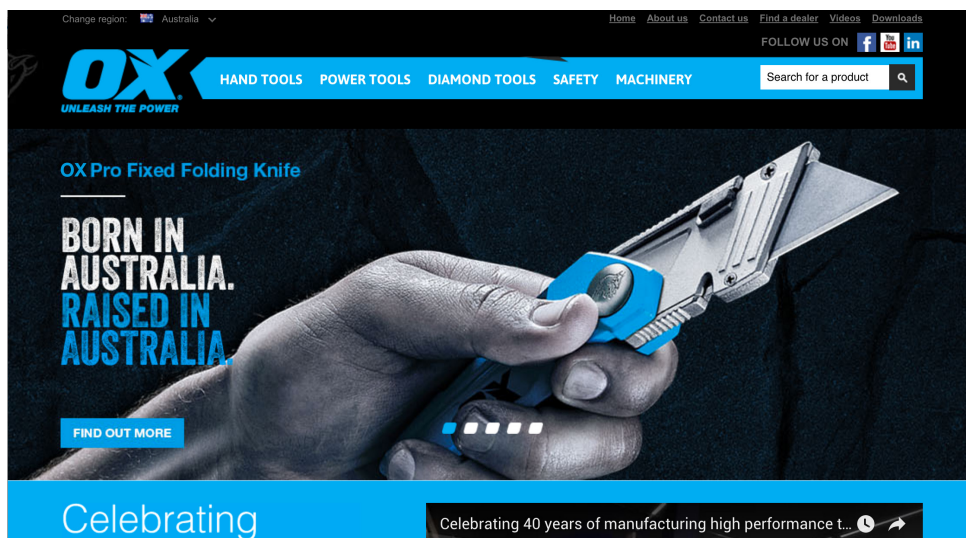

Look out for the new product updates

OX Energy Drinks for your store!



New Products!

Concrete
Sprayer



page
62

Wedges



page
106

Block Carrier



page
79

7 Piece Screwdriver Set



page
141

Hand Saw



page
149

Thin Turbo Diamond
Blades



page
28

Step Ups



page
167

Washkit



page
115

Walking
Groover



page
58

Ball Jointer



page
71

Chalk Line
Reel



page
134

Bricklayer's Clamp



page
78

Tote Bag



page
174

Contents

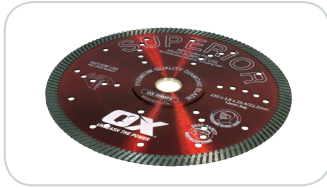

Diamond Tools
pages 10-39



Concreting Tools
pages 40-65



Bricklaying Tools
pages 66-81



Plastering Tools
pages 82-87



Rendering Tools
pages 88-101



Tiling Tools
pages 102-115



Striking Tools
pages 116-123



Measuring Tools
pages 124-129



Layout Tools
pages 130-135



Woodworking Tools
pages 136-143



Cutting Tools
pages 144-151



Demolition Tools
pages 152-159



Plumbing and Electrical
pages 160-163



Site Tools & Accessories
pages 164-171



Tool Storage
pages 172-177



Safety Equipment
pages 178-185



Indent Container Program
pages 186-201



Planograms
pages 202-211



Merchandising
pages 212-223

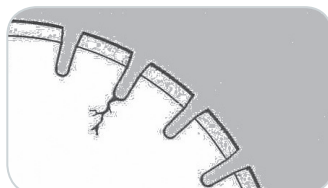

Diamond Trouble Shooting Guide
pages 224-228



Index / FAQ
pages 229-237



Diamond Tools

OX has been innovating diamond tools for over 20 years and is now clearly recognized as one of the leading brands of choice and at the forefront of technology.

With our 23 years of experience as well as our product and market innovation, we deliver ingenious design solutions to meet ever-evolving customer requirements.

Our first class award winning diamond tools are produced in some of the world's most technically advanced laboratories and factories, guaranteeing the highest manufacturing quality.





World leading technology

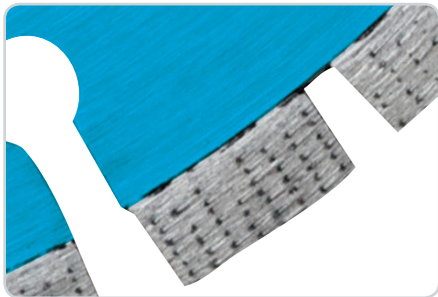

Only the finest quality of diamond is used in the production of OX blades.

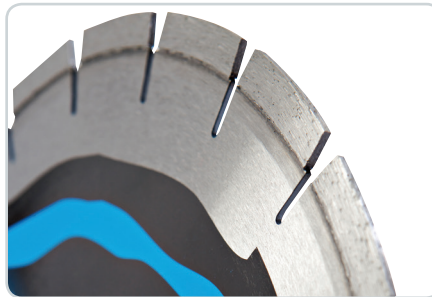

State of the art laser technology for ultimate performance and safety.



Blade & cores are made of the highest quality steel, precision engineered, ground and hardened.

Product guarantees & safety

The concept of safety is fundamental to the philosophy of the OX range. It is interwoven into the very fibre of innovation, design and production from concept to after sales service.



ISO 9001:2015
OX Group systems have been fully certified to ISO 9001:2015.



EN13236
Blades conform with European and UK standards.



Full 'No Hassle' Guarantee
All OX Diamond products are backed by our full 'No Hassle' guarantee – Ensuring confidence of distributors and their customers.



Diamond Innovation
Ongoing development provides increased performance on existing products, and innovative new diamond solutions.



Safety Instructions
Products undergo rigorous safety and vibration testing at our research & development facility, and in the field.



Ultimate Guarantee
Ultimate products undergo extreme testing – the UU10 blade undergoes factory testing +80% more demanding than the requirements of EN13236.



Hand/Arm Vibration
OX Diamond products were among the first to be tested and certified safe for hand/arm vibration.



Extra Safe
Our safety policy is an integral part of our company ethos with policies incorporating ISO18001.



Environmental
Showing that we care: Manufacturing operations accredited to ISO 14001 environmental systems.

We have a responsibility. Quality control systems and environmental and safety management ensure that our care covers not only our products and our customers – but that our ethical guidelines address issues such as staff safety and care for the environment.



Diamond Blade Application Matrix

RECOMMENDATION GUIDE

For specific advice, refer to your supplier

WILL CUT WELL

WILL CUT

WILL NOT CUT

MATERIAL	BLADE MODEL														
	DC10	DU10	TU10	TC10	TB10	TA10	MPS	MPSS	LCO	PB10	PA10	UU10	UC10	UB10	UA10
Aerated Concrete	👍	👍	👉	👍	👍	👍	👉	👉	👍	👍	👍	👉	👍	👍	👍
Alumina	👎	👎	👎	👎	👎	👎	👎	👎	👎	👎	👎	👎	👎	👎	👎
Asphalt / Bitumen	👎	👎	👎	👎	👉	👍	👎	👎	👎	👉	👍	👎	👎	👉	👍
Bluestone	👎	👉	👍	👎	👎	👎	👍	👍	👉	👎	👎	👍	👉	👎	👎
Brick - Clay	👎	👉	👍	👎	👎	👎	👍	👍	👎	👎	👎	👍	👎	👎	👎
Brick - Concrete	👉	👉	👉	👍	👍	👍	👉	👉	👉	👍	👉	👉	👉	👍	👎
Brick - Lightweight	👍	👉	👉	👍	👍	👉	👉	👉	👍	👍	👉	👉	👍	👍	👉
Brick - Refractory	👎	👉	👉	👎	👎	👎	👍	👍	👎	👎	👎	👍	👎	👎	👎
Ceramic Tiles - General	👎	👎	👎	👎	👎	👎	👎	👎	👎	👎	👎	👎	👎	👎	👎
Ceramic Tiles - Fully Vitrified	👎	👎	👎	👎	👎	👎	👎	👎	👎	👎	👎	👎	👎	👎	👎
Cement - Sheetting	👍	👉	👍	👉	👉	👎	👍	👍	👉	👉	👎	👍	👉	👉	👎
Cement - Block	👍	👉	👉	👍	👍	👍	👉	👉	👉	👍	👉	👎	👉	👍	👉
Cement - Roof Tiles	👉	👉	👉	👍	👍	👍	👉	👉	👉	👍	👉	👎	👉	👍	👉
Cement - Pipe	👉	👉	👉	👍	👍	👎	👉	👉	👍	👉	👎	👉	👍	👉	👎
Concrete - Cured	👉	👉	👉	👍	👉	👉	👉	👉	👍	👉	👎	👉	👍	👉	👎
Concrete - Cured Reinforced	👎	👎	👉	👍	👉	👎	👉	👉	👍	👉	👎	👉	👍	👉	👎
Concrete - Green	👎	👎	👎	👎	👉	👍	👉	👉	👎	👉	👍	👎	👎	👉	👍
Concrete - Lightweight	👍	👍	👉	👍	👍	👍	👉	👉	👍	👉	👉	👎	👍	👍	👉
Demolition Work	👎	👉	👍	👎	👎	👎	👍	👍	👎	👎	👎	👎	👎	👎	👎
Engineered Stone	👎	👎	👎	👎	👎	👎	👎	👎	👎	👎	👎	👎	👎	👎	👎
Fibreglass	👎	👎	👉	👎	👎	👎	👉	👎	👎	👎	👎	👎	👎	👎	👎
Fibre Cement Sheet	👍	👍	👍	👉	👉	👎	👍	👍	👉	👉	👎	👎	👉	👉	👎
Granite	👎	👉	👍	👎	👎	👎	👍	👍	👎	👎	👎	👍	👉	👎	👎
Glass	👎	👎	👎	👎	👎	👎	👎	👎	👎	👎	👎	👎	👉	👎	👎
Limestone	👎	👉	👍	👎	👉	👎	👍	👍	👉	👉	👎	👍	👍	👉	👍
Mortar	👎	👎	👎	👎	👉	👍	👎	👎	👎	👉	👍	👎	👎	👉	👎
Marble	👎	👎	👎	👎	👎	👎	👎	👎	👎	👎	👎	👎	👎	👎	👎
Porcelain	👎	👎	👎	👎	👎	👎	👎	👎	👎	👎	👎	👎	👎	👎	👎
Roof Tiles - Clay	👎	👍	👍	👎	👎	👎	👍	👍	👉	👎	👎	👍	👉	👎	👎
Roof Tiles - Cement	👉	👉	👎	👉	👍	👎	👉	👉	👎	👍	👎	👎	👉	👍	👉
Sandstone	👉	👉	👉	👉	👉	👍	👉	👉	👉	👍	👍	👎	👉	👍	👍
Slate	👉	👍	👍	👎	👎	👉	👍	👍	👍	👉	👎	👍	👍	👉	👎
Steel	👎	👎	👉	👎	👎	👎	👉	👎	👎	👎	👎	👎	👎	👎	👎
Terracotta	👎	👎	👎	👎	👎	👎	👎	👎	👎	👎	👎	👎	👎	👎	👎
Terazzo	👎	👎	👎	👎	👎	👎	👎	👎	👎	👎	👎	👎	👎	👎	👎
Wall Chasing	👉	👎	👉	👉	👉	👎	👎	👎	👉	👉	👎	👎	👉	👉	👎



Blade selection & presentation



Performance Classes

STANDARD SERIES

Entry level contractor range – an industry benchmark.

TRADE SERIES

Exceptional value for the price conscious buyer who wants something better.

PRO SERIES

The award winning, best selling superior blades – including the MPS – the best all round builders blade on the market.

ULTIMATE SERIES

When nothing but the best will do. 'Ultimate' says it all.



Material Classes

U CLASS

UNIVERSAL HARD

Hard materials & metal
Fast cutting universal
Hard natural stone
Clay products
Engineering bricks

C CLASS

CONCRETE / GENERAL PURPOSE

Concrete & concrete
products
General purpose
Unabrasive products
Building products

B CLASS

ABRASIVE / GENERAL PURPOSE

Abrasive materials
Concrete & asphalt
Dual purpose
Concrete products
Concrete roof tiles

A CLASS

ASPHALT

Asphalt & extremely
abrasive products
Cement screed
Lignacite blocks.

QUALITY: **STANDARD SERIES**

prefix: D



DU10



DC10

QUALITY: **TRADE SERIES**

prefix: T



TU10



TC10



TB10



TA10

QUALITY: **PRO SERIES**

prefix: P



MPS



LCO



PB10



PA10

QUALITY: **ULTIMATE SERIES**

prefix: U



UU10

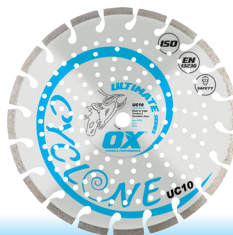

UC10



UB10



UA10

Logical separation of each different diamond blade into different material classes

Very clear quality bands



The STANDARD Series gives the benefit of a safe performing product for the cost conscious user.



STANDARD DU10 GENERAL PURPOSE

General purpose turbo blade with robust 10mm segment height. Applications include concrete products, bricks and slabs, roof tiles and concrete pavers.

Product code	Barcode	Diameter (in)	Bore (mm)	RPM	Inner Qty	Outer Qty	List Price
OX-DU10-4	9341231032684	4	16	14500	6	24	\$11.02
OX-DU10-4.5	9341231032691	4 1/2	22.2/20	13200	6	24	\$12.74
OX-DU10-5	9341231032707	5	22.2/20	12000	6	24	\$14.06
OX-DU10-9	9341231032745	9	25.4/22.2	6600	6	24	\$34.18

OX DC10: setting the standard

The DC10 remains the No. 1 standard general purpose blade and an industry benchmark for our competitors to aspire to. Robust 10mm segment height gives an increased life of 43% over the original 7mm segment.

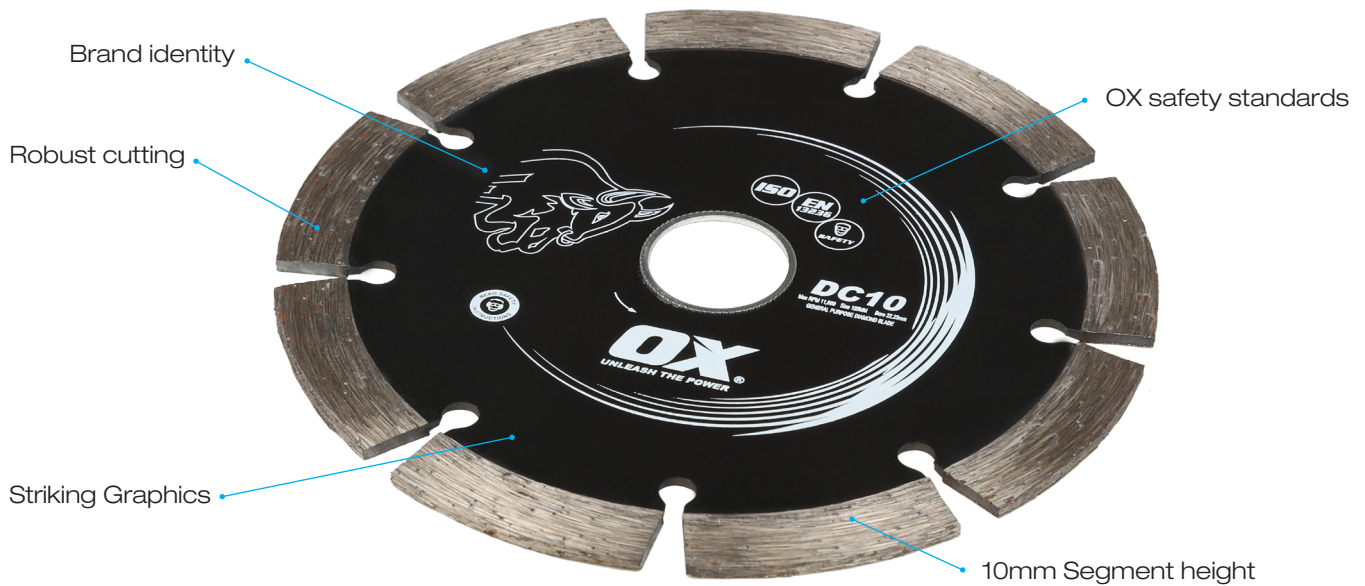

STANDARD DC10 GENERAL PURPOSE

Best selling general purpose blade with robust 10mm segment height. Applications include: bricks and slabs, concrete pavers, roof tiles, concrete products.

Product code	Barcode	Diameter (in)	Bore (mm)	RPM	Inner Qty	Outer Qty	List Price
OX-DC10-4	9341231003608	4	16	14500	6	24	\$9.89
OX-DC10-4.5	9341231003615	4 1/2	22.2/20	13200	6	24	\$10.77
OX-DC10-5	9341231003622	5	22.2/20	12000	6	24	\$12.32
OX-DC10-6	9341231003639	6	25.4/22.2	10200	6	24	\$15.39
OX-DC10-7	9341231003646	7	25.4/22.2	8500	6	24	\$15.83
OX-DC10-8	9341231003653	8	30/25.4	7600	6	24	\$24.18
OX-DC10-9	9341231003660	9	25.4/22.2	6600	6	24	\$30.34
OX-DC10-14	9341231003684	14	25.4/22.2	5400	5	10	\$106.04
OX-DC10-16	9341231003691	16	25.4/22.2	4800	N/A	5	\$137.62



TRADE TU10 UNIVERSAL/HARD

Fast cutting universal blade, with 10mm segment height. Features super fast turbo segment and cooling holes. CUTS IT ALL – GUARANTEED. Applications include: concrete products, clay products, granite, engineering bricks, building products.

Product code	Barcode	Diameter (in)	Bore (mm)	RPM	Inner Qty	Outer Qty	List Price
OX-TU10-4	9341231002007	4	16	14500	6	24	\$24.64
OX-TU10-4.5	9341231002014	4 ½	22.2/20	13200	6	24	\$26.79
OX-TU10-5	9341231002021	5	22.2/20	12000	6	24	\$28.93
OX-TU10-6	9341231002038	6	25.4/20	10200	6	24	\$38.34
OX-TU10-7	9341231002045	7	25.4/22.2	8500	6	24	\$43.65
OX-TU10-8	9341231002052	8	30/25.4	7600	6	24	\$52.21
OX-TU10-9	9341231002069	9	25.4/22.2	6600	6	24	\$61.99
OX-TU10-14	9341231002083	14	25.4/20	5400	5	10	\$186.85



TRADE TC10 CONCRETE

The general purpose blade with a 10mm segment height. All round performance. Applications include: building products, general purpose, kerbs and slabs, concrete pavers and blocks, roof tiles.

Product code	Barcode	Diameter (in)	Bore (mm)	RPM	Inner Qty	Outer Qty	List Price
OX-TC10-4	9341231002106	4	16	14500	6	24	\$15.39
OX-TC10-4.5	9341231002113	4 ½	22.2/20	13200	6	24	\$16.49
OX-TC10-5	9341231002120	5	22.2/20	12000	6	24	\$18.69
OX-TC10-6	9341231002137	6	25.4/20	10200	6	24	\$27.98
OX-TC10-7	9341231002144	7	25.4/22.2	8500	6	24	\$32.98
OX-TC10-8	9341231002151	8	30/25.4	7600	6	24	\$41.77
OX-TC10-9	9341231002168	9	25.4/22.2	6600	6	24	\$49.47
OX-TC10-12	9341231002175	12	25.4/20	5100	5	10	\$171.47
OX-TC10-14	9341231002182	14	25.4/20	5400	5	10	\$186.85
OX-TC10-16	9341231020346	16	25.4/20	4800	N/A	5	\$215.42



TRADE TB10 ABRASIVE/GENERAL PURPOSE

Abrasive and general purpose blade with 10mm segment height. Applications include: general and abrasive building products, concrete pavers, concrete roof tiles, hard asphalt, breeze blocks.

Product code	Barcode	Diameter (in)	Bore (mm)	RPM	Inner Qty	Outer Qty	List Price
OX-TB10-4	9341231002205	4	16	14500	6	24	\$15.39
OX-TB10-4.5	9341231002212	4 ½	22.2/20	13200	6	24	\$16.49
OX-TB10-5	9341231002229	5	22.2/20	12000	6	24	\$18.69
OX-TB10-6	9341231002236	6	25.4/20	10200	6	24	\$27.48
OX-TB10-7	9341231002243	7	25.4/22.2	8500	6	24	\$32.98
OX-TB10-8	9341231002250	8	30/25.4	7600	6	24	\$41.77
OX-TB10-9	9341231002267	9	25.4/22.2	6600	6	24	\$49.47
OX-TB10-14	9341231002281	14	25.4/20	5400	5	10	\$186.85
OX-TB10-16	9341231002298	16	25.4/20	4800	N/A	5	\$215.42



TRADE TA10 ASPHALT

Asphalt blade with 10mm segment height and wedge undercut protection. Applications include: asphalt and extremely abrasive materials, render.

Product code	Barcode	Diameter (in)	Bore (mm)	RPM	Inner Qty	Outer Qty	List Price
OX-TA10-14	9341231002311	14	25.4.20	5400	5	10	\$186.85





The blade that is...

GUARANTEED

To cut ALL masonry construction products!

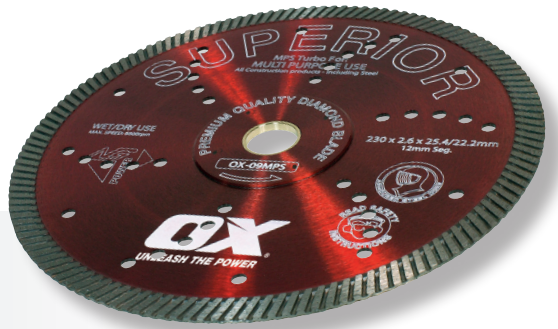

SUPERFAST TURBO segment technology combines aggressive cutting ability with a fine, clean cut and no burning of the segments. Eliminating the possibility of single segment detachment.



REINFORCED, EXTRA SECURE, DUAL CENTRE FLANGE AND UNIQUE COOL-FAST DESIGN for a quieter, cooler and safer blade, with no distortion in the cut.



In use, the blade is semi-transparent and cuts out much of the vibration associated with conventional diamond tools.



Safety and vibration tested to meet and surpass relevant standards. Conforms with EN13236.



CUTS EVERYTHING ON A CONSTRUCTION SITE!

PRO MPS UNIVERSAL/HARD

Guaranteed to cut all masonry construction products including metal. Excellent fast cut on universal & hard materials. Reinforced flange. Cooling holes. Semi-transparent. Applications include: granite, natural stone, clay products, engineering bricks, metal, concrete products, all building materials. Wear will increase on abrasive materials. 12mm segment height.

Product code	Barcode	Diameter (in)	Bore (mm)	RPM	Inner Qty	Outer Qty	List Price
OX-04MPS	9341231002335	4	16	14500	6	24	\$46.59
OX-45MPS	9341231002342	4 1/2	22.2/20	13200	6	24	\$57.65
OX-05MPS	9341231002359	5	22.2/20	12000	6	24	\$63.30
OX-06MPS	9341231002366	6	25.4/20	10200	6	24	\$73.82
OX-07MPS	9341231002373	7	25.4/22.2	8500	6	24	\$87.86
OX-08MPS	9341231002380	8	30/25.4	7600	6	24	\$108.84
OX-09MPS	9341231002397	9	25.4/22.2	6600	6	24	\$113.16
OX-10MPS	9341231006279	10	25.4/20	6100	5	10	\$132.26
OX-14MPS	9341231002410	14	25.4/20	5400	5	10	\$347.30



CUTS EVERYTHING ON A CONSTRUCTION SITE!

Recommended for Travertine.

PRO SUPERFAST UNIVERSAL/HARD

Guaranteed to cut all masonry construction products. Excellent fast cut universal & hard materials. Reinforced flange. Cooling holes. Semi-transparent. Applications include: granite, natural stone, clay products, engineering bricks, concrete products, all building materials. Wear will increase on abrasive materials. 15mm segment height. Not recommended for reinforced concrete - use MPS blade.

Product code	Barcode	Diameter (in)	Bore (mm)	RPM	Inner Qty	Outer Qty	List Price
OX-12MPSS	9341231021541	12	25.4/20	5400	5	10	\$324.11
OX-14MPSS	9341231003189	14	25.4/20	5400	5	10	\$331.52
OX-16MPSS	9328217012502	16	25.4/20	4800	N/A	5	\$410.97



PRO LCO CYCLONE CONCRETE

Durable 'Cuts it all' general purpose and concrete products blade with 10mm segment height. Applications include: cured reinforced concrete, concrete kerbs and slabs, concrete pavers, roof tiles, bricks, general building materials.

Product code	Barcode	Diameter (in)	Bore (mm)	RPM	Inner Qty	Outer Qty	List Price
OX-LCO-12	9328217004750	12	25.4/20	5060	5	10	\$307.56
OX-LCO-14	9341231002519	14	25.4/20	4300	5	10	\$349.78
OX-LCO-16	9341231020353	16	25.4/20	3800	N/A	5	\$411.83



PRO PB10 ZEBRA ABRASIVE/GENERAL PURPOSE

High performance dual purpose blade with 10mm segment height. Applications include: abrasive building materials, concrete products, roof tiles, blocks, floorsaw concrete & dual concrete/asphalt.

Product code	Barcode	Diameter (in)	Bore (mm)	RPM	Inner Qty	Outer Qty	List Price
OX-PB10-4	9341231002533	4	16	14500	6	24	\$27.46
OX-PB10-4.5	9341231002540	4 1/2	22.2/20	13200	6	24	\$27.52
OX-PB10-5	9341231002557	5	22.2/20	12000	6	24	\$32.98
OX-PB10-6	9341231002564	6	25.4/20	10200	6	24	\$53.20
OX-PB10-7	9341231002571	7	25.4/22.2	8500	6	24	\$61.56
OX-PB10-8	9341231002588	8	30/25.4	7600	6	24	\$81.33
OX-PB10-9	9341231002595	9	25.4/22.2	6600	6	24	\$96.72
OX-PB10-14	9341231002618	14	25.4/20	4300	5	10	\$314.36
OX-PB10-16	9341231020360	16	25.4/20	3800	N/A	5	\$373.71



PRO PA10 SHARK ASPHALT

Undercut protected blade with 10mm segment height. Applications include: asphalt and extremely abrasive products.

Product code	Barcode	Diameter (in)	Bore (mm)	RPM	Inner Qty	Outer Qty	List Price
OX-PA10-14	9341231002649	14	25.4/20	4300	5	10	\$314.36
OX-PA10-16	9341231002656	16	25.4/20	3800	N/A	5	\$373.71





Angle Grinders & Demolition Saws

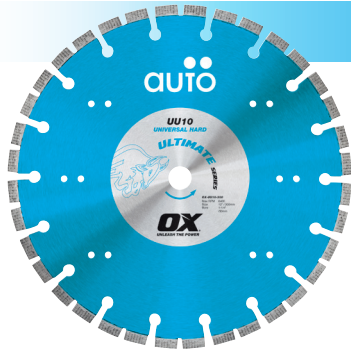

ULTIMATE UU10 AUTO UNIVERSAL/HARD

Fast cutting universal blade with 10mm segment height. Featuring turbo segment, cooling holes, reinforced centre flange. Applications include: hard natural stone, concrete & clay products, engineering bricks & general building products.

Product code	Barcode	Diameter (in)	Bore (mm)	RPM	Inner Qty	Outer Qty	List Price
OX-UU10-9	9341231002724	9	25.4/22.2	6600	6	24	\$189.20
OX-UU10-14	9341231002748	14	25.4/20	5400	5	10	\$483.63
OX-UU10-16	9341231035081	16	25.4/20	3800	N/A	5	\$610.38



ULTIMATE UC10 CYCLONE CONCRETE PRODUCTS

Blade with 10mm segment height. Featuring tear drop gullet design, cooling holes, reinforced centre flange. Applications include: in-situ concrete (including reinforced), concrete products, natural stone, building materials. Ideal 'civils' blade.

Product code	Barcode	Diameter (in)	Bore (mm)	RPM	Inner Qty	Outer Qty	List Price
OX-UC10-4	9341231002762	4	16	14500	6	24	\$37.37
OX-UC10-4.5	9341231002779	4 1/2	22.2/20	13200	6	24	\$43.97
OX-UC10-5	9341231002786	5	22.2/20	12000	6	24	\$54.96
OX-UC10-6	9341231002793	6	25.4/20	10200	6	24	\$72.55
OX-UC10-7	9341231002809	7	25.4/22.2	8500	6	24	\$101.12
OX-UC10-8	9341231002816	8	30/25.4	7600	6	24	\$127.50
OX-UC10-9	9341231002823	9	25.4/22.2	6600	6	24	\$151.68
OX-UC10-14	9341231002847	14	25.4/20	5400	5	10	\$384.70
OX-UC10-16	9341231020377	16	25.4/20	4800	N/A	5	\$417.68



ULTIMATE UB10 ZEBRA ABRASIVE

Dual purpose blade with 10mm segment height. Featuring 'wedge segment' undercut protection, narrow gullet. Applications include: dual purpose concrete & asphalt, sandstone, abrasive materials and abrasive concrete products (e.g. roof tiles, blocks).

Product code	Barcode	Diameter (in)	Bore (mm)	RPM	Inner Qty	Outer Qty	List Price
OX-UB10-4	9341231002861	4	16	14500	6	24	\$37.36
OX-UB10-4.5	9341231002878	4 1/2	22.2/20	13200	6	24	\$43.97
OX-UB10-5	9341231002885	5	22.2/20	12000	6	24	\$54.96
OX-UB10-6	9341231002892	6	25.4/20	10200	6	24	\$72.55
OX-UB10-7	9341231002908	7	25.4/22.2	8500	6	24	\$101.12
OX-UB10-8	9341231002915	8	30/25.4	7600	6	24	\$127.50
OX-UB10-9	9341231002922	9	25.4/22.2	6600	6	24	\$151.68
OX-UB10-14	9341231012310	14	25.4/20	5400	5	10	\$384.70
OX-UB10-16	9341231002953	16	25.4/20	4800	N/A	5	\$417.68



ULTIMATE UA10 BLACK SHARK ASPHALT

Asphalt blade with 10mm segment height. Featuring 'wedge segment' undercut protection, 'U' clearance gullet. Applications include: asphalt & extremely abrasive products, cement screed, lignacite blocks.

Product code	Barcode	Diameter (in)	Bore (mm)	RPM	Inner Qty	Outer Qty	List Price
OX-UA10-14	9341231002977	14	25.4/20	5400	5	10	\$384.70
OX-UA10-16	9341231002984	16	25.4/20	4800	N/A	5	\$417.68



Material Classes

U CLASS

UNIVERSAL HARD

Concrete pavers
Clay products
Granite
Engineering bricks
Hard bricks

H CLASS

HARD BRICK

Medium to hard
Clay bricks and pavers

C CLASS

COMBINATION

Clay bricks
Clay pavers
Concrete pavers

S CLASS

SOFT BRICK

Concrete pavers
Besser blocks
Sandstone
Pavers Lignacite blocks

QUALITY: **TRADE SERIES**

prefix: T



TUB



THB



TCB



TSB

Logical separation of each different diamond blade into different material classes

QUALITY: **PRO SERIES**

prefix: P



MPSS



PHB



PCB



PSB

Very clear quality bands

QUALITY: **SILENTYPE SERIES**



PHBS



PCBS



PSBS



Bricksaw & Blocksaw Blades



TRADE TUB UNIVERSAL

Fast cutting universal blade, with 12mm segment height. Features super fast turbo segment and cooling holes. CUTS IT ALL – GUARANTEED. Applications include: concrete pavers, clay products, granite, engineering bricks and hard bricks.

Product code	Barcode	Diameter (in)	Bore (mm)	RPM	Inner Qty	Outer Qty	List Price
OX-TUB-14	9341231003004	14	25.4/20	5400	5	10	\$272.43
OX-TUB-16	9341231035043	16	25.4/20	4800	N/A	5	\$342.50



TRADE THB HARD BRICK

The hard brick blade with sintered segment. Applications include medium to hard clay bricks and pavers.

Product code	Barcode	Diameter (in)	Bore (mm)	RPM	Inner Qty	Outer Qty	List Price
OX-THB-14	9341231003059	14	25.4/20	4300	5	10	\$186.86
OX-THB-16	9341231003066	16	25.4/20	3800	N/A	5	\$215.44



TRADE TCB 50 / 50 COMBINATION

The combination blade with sintered segment. Applications include 50/50 clay/concrete, clay bricks and pavers.

Product code	Barcode	Diameter (in)	Bore (mm)	RPM	Inner Qty	Outer Qty	List Price
OX-TCB-14	9341231003080	14	25.4/20	4300	5	10	\$186.86
OX-TCB-16	9341231003097	16	25.4/20	3800	N/A	5	\$215.44



TRADE TSB SOFT BRICK

The soft brick/block blade for abrasive materials. Sintered welded segment. Applications include concrete, pavers, besser blocks and sandstone.

Product code	Barcode	Diameter (in)	Bore (mm)	RPM	Inner Qty	Outer Qty	List Price
OX-TSB-14	9341231003134	14	25.4/20	4300	5	10	\$186.86
OX-TSB-16	9341231003141	16	25.4/20	3800	N/A	5	\$215.44



PRO MPSS UNIVERSAL

Guaranteed to cut all construction products. 15mm segment height. Excellent fast cut universal & hard materials. Reinforced flange. Cooling holes. Semi-transparent. Applications include: granite, natural stone, clay products, engineering bricks, concrete pavers and hard bricks. Wear will increase on abrasive materials. Ideal for travertine.

Product code	Barcode	Diameter (in)	Bore (mm)	RPM	Inner Qty	Outer Qty	List Price
OX-12MPSS	9341231003172	12	25.4/20	5400	5	10	\$324.11
OX-14MPSS	9341231003189	14	25.4/20	5400	5	10	\$331.52
OX-16MPSS	9341231003196	16	25.4/20	4800	N/A	5	\$410.97



Recommended for Travertine

PRO PHB HARD BRICK

The hard brick blade with laser welded segments. Applications include medium to hard clay bricks and pavers.

Product code	Barcode	Diameter (in)	Bore (mm)	RPM	Inner Qty	Outer Qty	List Price
OX-PHB-14	9341231003233	14	25.4/20	4300	5	10	\$314.36
OX-PHB-16	9341231003240	16	25.4/20	3800	N/A	5	\$373.71



PRO PCB 50 / 50 COMBINATION

The combination blade with laser welded segment. Applications include 50/50 clay/concrete, clay bricks and pavers.

Product code	Barcode	Diameter (in)	Bore (mm)	RPM	Inner Qty	Outer Qty	List Price
OX-PCB-14	9341231003264	14	25.4/20	4300	5	10	\$314.36
OX-PCB-16	9341231003271	16	25.4/20	3800	N/A	5	\$373.71
OX-PCB-18	9341231003288	18	25.4/20	3350	N/A	2	\$450.65
OX-PCB-20	9341231003295	20	25.4/20	3050	N/A	2	\$571.56



PRO PSB SOFT BRICK

The soft brick/block blade for abrasive materials. Applications include concrete pavers and besser blocks.

Product code	Barcode	Diameter (in)	Bore (mm)	RPM	Inner Qty	Outer Qty	List Price
OX-PSB-14	9341231003318	14	25.4/20	4300	5	10	\$314.36
OX-PSB-16	9341231003325	16	25.4/20	3800	N/A	5	\$373.71
OX-PSB-18	9341231003332	18	25.4/20	3350	N/A	2	\$450.65
OX-PSB-20	9341231003349	20	25.4/20	3050	N/A	2	\$571.56





Bricksaw & Blocksaw Blades-Silent



PRO PHBS HARD BRICK SILENTYPE

Laminated core for noise reduction. The hard brick blade with laser welded segments. Applications include medium to hard clay bricks and pavers.

Product code	Barcode	Diameter (in)	Bore (mm)	RPM	Inner Qty	Outer Qty	List Price
OX-PHBS-14	9341231003363	14	25.4/20	4300	5	10	\$362.73
OX-PHBS-16	9341231003370	16	25.4/20	3800	N/A	5	\$428.67



PRO PCBS 50 / 50 COMBINATION SILENTYPE

Laminated core for noise reduction. The combination blade with laser welded segment. Applications include 50/50 clay/concrete, clay bricks and pavers.

Product code	Barcode	Diameter (in)	Bore (mm)	RPM	Inner Qty	Outer Qty	List Price
OX-PCBS-14	9341231003394	14	25.4/20	4300	5	10	\$362.73
OX-PCBS-16	9341231003400	16	25.4/20	3800	N/A	5	\$428.67
OX-PCBS-18	9341231003417	18	25.4/20	3350	N/A	2	\$637.51
OX-PCBS-20	9341231003424	20	25.4/20	3050	N/A	2	\$739.42



PRO PSBS SOFT BRICK SILENTYPE

Laminated core for noise reduction. The soft brick/block blade for abrasive materials. Applications include concrete pavers and besser blocks.

Product code	Barcode	Diameter (in)	Bore (mm)	RPM	Inner Qty	Outer Qty	List Price
OX-PSBS-14	9341231003448	14	25.4/20	4300	5	10	\$362.73
OX-PSBS-16	9341231003455	16	25.4/20	3800	N/A	5	\$428.67
OX-PSBS-18	9341231003462	18	25.4/20	3350	N/A	2	\$637.51
OX-PSBS-20	9341231003479	20	25.4/20	3050	N/A	2	\$739.42



Material Classes

C CLASS CONCRETE / GENERAL PURPOSE

Concrete & concrete products
General purpose
Unabrasive products
Building products

B CLASS ABRASIVE / GENERAL PURPOSE

Abrasive materials
Concrete & asphalt
Dual purpose
Concrete products
Concrete roof tiles

A CLASS ASPHALT

Asphalt & extremely abrasive products
Cement screed
Lignacite blocks

S CLASS SPECIALIST

Abrasive materials
Green concrete
Asphalt over concrete
Dual concrete
Asphalt

QUALITY: **PRO SERIES**

prefix: P



PCF



PBF



PAF



PSF

QUALITY: **ULTIMATE SERIES**

prefix: U



UCF



UBF



UAF

Logical separation of each different diamond blade into different material classes

Very clear quality bands



Floorsaw Blades



PRO PCF CONCRETE

High quality blade with 10mm segment height. Used by professionals. Applications include: in-situ concrete - flint and limestone aggregate, reinforced concrete.

Product code	Barcode	Diameter (in)	Bore (mm)	RPM	Inner Qty	Outer Qty	List Price
OX-PCF-16	9341231003707	16	25.4/20	3050	N/A	5	\$373.71
OX-PCF-18	9341231003714	18	25.4/20	2700	N/A	2	\$450.65
OX-PCF-20	9341231003721	20	25.4/20	2450	N/A	2	\$571.56
OX-PCF-24	9341231003738	24	25.4/20	2050	N/A	N/A	\$681.47



PRO PBF DUAL PURPOSE

Dual purpose blade with 10mm segment height and wedge undercut protection. Applications include: concrete and asphalt, abrasive concrete, concrete pavers.

Product code	Barcode	Diameter (in)	Bore (mm)	RPM	Inner Qty	Outer Qty	List Price
OX-PBF-16	9341231003745	16	25.4/20	4800	N/A	5	\$373.71
OX-PBF-18	9341231003752	18	25.4/20	3400	N/A	2	\$450.65
OX-PBF-20	9341231003769	20	25.4/20	3000	N/A	2	\$571.56
OX-PBF-24	9341231003776	24	25.4/20	2500	N/A	N/A	\$681.47



PRO PAF ASPHALT

High quality blade with 10mm segment height and wedge undercut protection. Applications include: Hot rolled and footway asphalt, cement screed.

Product code	Barcode	Diameter (in)	Bore (mm)	RPM	Inner Qty	Outer Qty	List Price
OX-PAF-16	9341231003783	16	25.4/20	4800	N/A	5	\$373.71
OX-PAF-18	9341231003790	18	25.4/20	3400	N/A	2	\$450.65
OX-PAF-20	9341231003806	20	25.4/20	3000	N/A	2	\$571.56
OX-PAF-24	9341231003813	24	25.4/20	2500	N/A	N/A	\$681.47



PRO PSF GREEN CONCRETE & ASPHALT OVER CONCRETE

Specialist blade with 10mm segment height. Featuring 'wedge segment' undercut protection and narrow slot. Applications include: green concrete, asphalt over concrete, dual concrete and asphalt, abrasive materials.

Product code	Barcode	Diameter (in)	Bore (mm)	RPM	Inner Qty	Outer Qty	List Price
OX-PSF-16	9341231003943	16	25.4/20	4800	N/A	5	\$373.71
OX-PSF-18	9341231003950	18	25.4/20	3400	N/A	2	\$450.65
OX-PSF-20	9341231003967	20	25.4/20	3000	N/A	2	\$571.56
OX-PSF-24	9341231003974	24	25.4/20	2500	N/A	N/A	\$681.47



ULTIMATE UCF CONCRETE

Extremely high quality blade with 10mm segment height. Used by professionals. Applications include: in-situ concrete - flint and limestone aggregate, reinforced concrete.

Product code	Barcode	Diameter (in)	Bore (mm)	RPM	Inner Qty	Outer Qty	List Price
OX-UCF-16	9341231003820	16	25.4/20	3050	N/A	5	\$567.16
OX-UCF-18	9341231003837	18	25.4/20	2700	N/A	2	\$701.26
OX-UCF-20	9341231003844	20	25.4/20	2450	N/A	2	\$888.12
OX-UCF-24	9341231003851	24	25.4/20	2050	N/A	N/A	\$1134.33



ULTIMATE UBF DUAL PURPOSE

Dual purpose blade with 10mm segment height. Featuring 'wedge segment' undercut protection, narrow gullet. Applications include: concrete and asphalt, abrasive concrete, asphalt over concrete, concrete pavers.

Product code	Barcode	Diameter (in)	Bore (mm)	RPM	Inner Qty	Outer Qty	List Price
OX-UBF-16	9341231003868	16	25.4/20	4800	N/A	5	\$567.16
OX-UBF-18	9341231003875	18	25.4/20	3400	N/A	2	\$701.27
OX-UBF-20	9341231003882	20	25.4/20	3000	N/A	2	\$888.12
OX-UBF-24	9341231003899	24	25.4/20	2500	N/A	N/A	\$1134.33



ULTIMATE UAF ASPHALT

Asphalt blade with 10mm segment height. Featuring 'wedge segment' undercut protection, 'U' clearance gullet. Applications include: hot rolled and footway asphalt, cement screed, extremely abrasive new green concrete.

Product code	Barcode	Diameter (in)	Bore (mm)	RPM	Inner Qty	Outer Qty	List Price
OX-UAF-16	9341231003905	16	25.4/20	4800	N/A	5	\$567.16
OX-UAF-18	9341231003912	18	25.4/20	3400	N/A	2	\$701.26
OX-UAF-20	9341231003929	20	25.4/20	3000	N/A	2	\$888.12
OX-UAF-24	9341231003936	24	25.4/20	2500	N/A	N/A	\$1134.32





Ceramic & Stone Tiling Blades

TRADE TCT CERAMICS



Continuous rim diamond blade for cutting ceramic tiles. Popular sizes. Applications include: ceramic tiles.

Product code	Barcode	Diameter (in)	Bore (mm)	RPM	Inner Qty	Outer Qty	List Price
OX-TCT-4	9341231004070	4	16	14500	6	24	\$10.55
OX-TCT-4.5	9341231004087	4 1/2	22.2/20	13200	6	24	\$12.09
OX-TCT-5	9341231004094	5	22.2/20	12000	6	24	\$13.19
OX-TCT-6	9341231004100	6	25.4/22.2	10200	6	24	\$15.83
OX-TCT-7	9341231004117	7	25.4/22.2	8500	6	24	\$19.79
OX-TCT-8	9341231004124	8	30/25.4	7600	6	24	\$26.38
OX-TCT-9	9341231004131	9	30/25.4	6600	6	24	\$39.57
OX-TCT-10	9341231004148	10	30/25.4	6100	6	24	\$61.56
OX-TCT-14	9341231004162	14	30/25.4	5400	5	10	\$131.90

ULTIMATE UCT CERAMICS



Featuring 10mm continuous rim, fine cut, high concentration, s-slot cool cutting, s-detenso silencing. Cuts all tiles - guaranteed! Applications include: ceramic tiles, natural stone, porcelain, granite, marble.

Product code	Barcode	Diameter (in)	Bore (mm)	RPM	Inner Qty	Outer Qty	List Price
OX-UCT-4	9341231004278	4	16	14500	6	24	\$32.98
OX-UCT-4.5	9341231004285	4 1/2	22.2/20	13200	6	24	\$43.53
OX-UCT-5	9341231004292	5	22.2/20	12000	6	24	\$47.49
OX-UCT-6	9341231004308	6	25.4/22.2	10200	6	24	\$56.98
OX-UCT-7	9341231004315	7	25.4/22.2	8500	6	24	\$71.23
OX-UCT-8	9341231004322	8	30/25.4	7600	6	24	\$94.96
OX-UCT-9	9341231004339	9	30/25.4	6600	6	24	\$112.11
OX-UCT-10	9341231004346	10	30/25.4	6100	6	24	\$193.45
OX-UCT-12	9341231004353	12	30/25.4	5400	5	10	\$213.74
OX-UCT-14	9341231004360	14	30/25.4	4300	5	10	\$316.56

ULTIMATE UCFT FINE TURBO PORCELAIN

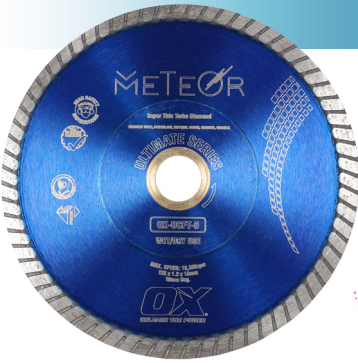

Super thin turbo with 7mm segment height. The finest cut for porcelain. Applications include: porcelain, ceramic, natural stone, granite. 1.2mm Blade thickness.

Product code	Barcode	Diameter (in)	Bore (mm)	RPM	Inner Qty	Outer Qty	List Price
OX-UCFT-4	9341231015441	4	16	19, 100	6	24	\$47.35
OX-UCFT-4.5	9341231015458	4 1/2	16	16, 650	6	24	\$51.87
OX-UCFT-5	9341231015465	5	16	15, 300	6	24	\$58.15

New

ULTIMATE UCFM FINE MESH PORCELAIN

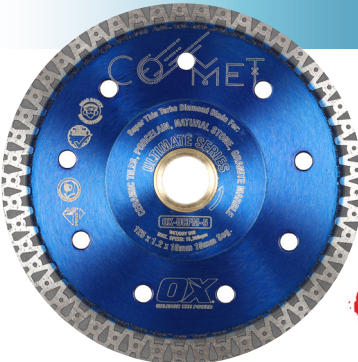

Super thin turbo with 10mm segment height. The finest cut for porcelain. Applications include: porcelain, ceramic, natural stone, granite. 1.2mm Blade thickness.

Product code	Barcode	Diameter (in)	Bore (mm)	RPM	Inner Qty	Outer Qty	List Price
OX-UCFM-4	9341231015472	4	16	19, 100	6	24	\$47.35
OX-UCFM-4.5	9341231015489	4 1/2	16	16, 650	6	24	\$51.87
OX-UCFM-5	9341231015496	5	16	15, 300	6	24	\$58.15

New

Tuck Pointing/Mortar Raking Blades



Tuck pointing diamond blades provide fast, effective removal of mortar joints prior to re-pointing. With a segment width of 6mm, OX mortar rakes are designed to cope with removal of most joint widths.

A thicker centre plate maintains a stable and durable cut and protects against undercutting.

The market leading PMR is now also available in 7" (180mm) for use on 7" and 9" angle grinders, offering more powerful cutting and greater cutting depth. The PMR puts less strain on a 9" angle grinder and is safer and more manageable than using a 9" (230mm) diameter blade in 6mm segment width.

TRADE TMR TUCK POINTING

6mm wide segment blade. Fantastic value for money product. Applications include: mortar raking, brick raking, abrasive materials.

Product code	Barcode	Diameter (in)	Bore (mm)	Inner Qty	Outer Qty	List Price
OX-TMR-4	9341231003974	4	16	N/A	6	\$50.01
OX-TMR-4.5	9341231014611	4 1/2	22.2/20	N/A	6	\$64.30
OX-TMR-5	9341231003998	5	22.2/20	N/A	6	\$68.59
OX-TMR-7	9341231004001	7	25.4/22.2	N/A	6	\$78.58



PRO PMR TUCK POINTING

High quality 6mm wide segment blade. The market leader – a great product to use. Fast cut/long life. Applications include: mortar raking, abrasive materials.

Product code	Barcode	Diameter (in)	Bore (mm)	Inner Qty	Outer Qty	List Price
OX-PMR-4	9341231031519	4	16	N/A	6	\$86.77
OX-PMR-4.5	9341231014628	4 1/2	22.2/20	N/A	6	\$106.54
OX-PMR-5	9341231004025	5	22.2/20	N/A	6	\$109.84
OX-PMR-7	9341231004032	7	25.4/22.2	N/A	6	\$157.85



ULTIMATE UMR TUCK POINTING

Ultimate - tuck pointing/mortar raking blade. Applications include: mortar raking, abrasive materials. 6mm wide segment blade.

Product code	Barcode	Diameter (in)	Bore (mm)	Inner Qty	Outer Qty	List Price
OX-UMR-4.5	9341231004049	4 1/2	22.2/20	N/A	6	\$170.78
OX-UMR-5	9341231004056	5	22.2/20	N/A	6	\$196.52
OX-UMR-7	9341231004063	7	25.4/22.2	N/A	6	\$239.25





Diamond Cup Wheels

Precision manufactured diamond grinding cups and heads for angle grinders and concrete planers. We also provide a range of specialist and bespoke grinding heads and tools for a variety of machines and applications.

Available in either 14mm thread or a 22.2mm bush.

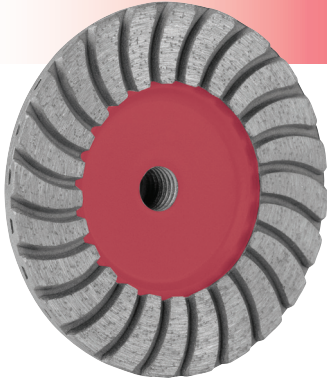

PRO PCTB TURBO CUP WHEEL

For stock removal, surface grinding and finishing. Universal applications. Transform your 4" grinder into a handy diamond grinding machine. Applications include: concrete and concrete products, natural stone, general building products.

Product code	Barcode	Diameter (in)	Bore (mm)	Grit	Inner Qty	Outer Qty	List Price
OX-PCTT-4	9341231004865	4	M14	30	N/A	6	\$82.67
OX-PCTB-4	9341231004872	4	22.2	30	N/A	6	\$70.35
OX-PCTT-5	9341231004889	5	M14	30	N/A	6	\$146.63
OX-PCTB-5	9341231004896	5	22.2	30	N/A	6	\$114.31
OX-PCTT-7	9341231004902	7	M14	30	N/A	6	\$180.27
OX-PCTB-7	9341231004919	7	22.2	30	N/A	6	\$165.75



ULTIMATE UCD DOUBLE ROW CUP WHEEL

Professional double row cup grinder for universal concrete, construction products and stone. Long life. Applications include: concrete, natural stone and construction products.

Product code	Barcode	Diameter (in)	Bore (mm)	Grit	Inner Qty	Outer Qty	List Price
OX-UCDT-4	9341231004926	4	M14	30	N/A	6	\$87.93
OX-UCDB-4	9341231004933	4	22.2	30	N/A	6	\$87.93
OX-UCDT-4.5	9341231004940	4 1/2	M14	30	N/A	6	\$98.92
OX-UCDB-4.5	9341231004957	4 1/2	22.2	30	N/A	6	\$98.92
OX-UCDT-5	9341231004964	5	M14	30	N/A	6	\$112.11
OX-UCDB-5	9341231004971	5	22.2	30	N/A	6	\$112.11
OX-UCDT-6	9341231004988	6	M14	30	N/A	6	\$142.89
OX-UCDB-6	9341231004995	6	22.2	30	N/A	6	\$142.89
OX-UCDT-7	9341231005088	7	M14	30	N/A	6	\$171.47
OX-UCDB-7	9341231005015	7	22.2	30	N/A	6	\$171.47





ULTIMATE UCG TURBO CUP WHEEL

Extremely versatile wide turbo designed for use with Makita PC1100. Fast cutting, long life. Applications include: concrete and natural stone.



FINE GRIT

Product code	Barcode	Diameter (in)	Bore (mm)	Grit	Inner Qty	Outer Qty	List Price
OX-UCGFT-4	9341231038112	4	M14	120	N/A	6	\$127.50
OX-UCGFB-4	9341231038082	4	22.2	120	N/A	6	\$127.50
OX-UCGFT-5	9341231038129	5	M14	120	N/A	6	\$141.50
OX-UCGFB-5	9341231038099	5	22.2	120	N/A	6	\$142.29
OX-UCGFT-7	9341231038136	7	M14	120	N/A	6	\$252.80
OX-UCGFB-7	9341231038105	7	22.2	120	N/A	6	\$255.42

MEDIUM GRIT

Product code	Barcode	Diameter (in)	Bore (mm)	Grit	Inner Qty	Outer Qty	List Price
OX-UCGMT-4	9341231038174	4	M14	60	N/A	6	\$127.50
OX-UCGMB-4	9341231038143	4	22.2	60	N/A	6	\$127.50
OX-UCGMT-5	9341231038181	5	M14	60	N/A	6	\$141.50
OX-UCGMB-5	9341231038150	5	22.2	60	N/A	6	\$142.29
OX-UCGMT-7	9341231038198	7	M14	60	N/A	6	\$252.80
OX-UCGMB-7	9341231038167	7	22.2	60	N/A	6	\$255.42

COARSE GRIT

Product code	Barcode	Diameter (in)	Bore (mm)	Grit	Inner Qty	Outer Qty	List Price
OX-UCGT-4	9341231005022	4	M14	30	N/A	6	\$127.50
OX-UCGB-4	9341231005039	4	22.2	30	N/A	6	\$127.50
OX-UCGT-4.5	9341231005046	4 1/2	M14	30	N/A	6	\$141.50
OX-UCGB-4.5	9341231005053	4 1/2	22.2	30	N/A	6	\$142.29
OX-UCGT-5	9341231005060	5	M14	30	N/A	6	\$156.64
OX-UCGB-5	9341231005077	5	22.2	30	N/A	6	\$164.95
OX-UCGT-7	9341231005084	7	M14	30	N/A	6	\$252.80
OX-UCGB-7	9341231005091	7	22.2	30	N/A	6	\$255.42



Displays and posters available. See page 222 and 223.

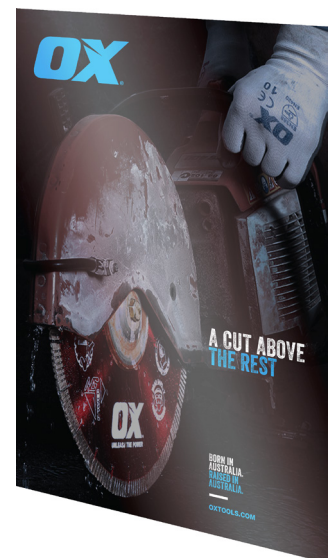



Specialist Blades



ULTIMATE UKB KARBITE BLADE

Product code	Barcode	Diameter (in)	Bore (mm)	RPM	Inner Qty	Outer Qty	List Price
OX-UKB-4	9341231005138	4	22.2	14500	N/A	6	\$105.56
OX-UKB-5	9341231005145	5	22.2	12000	N/A	6	\$125.47
OX-UKB-7	9341231020438	7	22.2	8500	N/A	4	\$174.02
OX-UKB-9	9341231005152	9	22.2	6600	N/A	4	\$300.32
OX-UKB-14	9341231020384	14	25.4/20	5400	N/A	4	\$384.85
OX-UKB-16	9341231034039	16	25.4/20	3800	N/A	4	\$431.04

What does the Karbite blade cut?

- Tree roots & soil
- Wooden boards & planks
- Fence panels
- Railway sleepers
- Small trees & branches
- Thin sheet metal
- Scaffold boards
- Wooden / plastic pallets
- Plywood
- Chipboard
- Nails & screws
- PE & PP plastics
- Flashing
- Decking
- Rubber
- Abrasive blocks
- Tar & mastic
- Flat roofing



ULTIMATE PCD FIBRE CEMENT BLADE

Product code	Barcode	Description	Size (mm)	Bore (mm)	Inner Qty	Outer Qty	List Price
OX-PCD-185	5060242335570	Ultimate Fibre Cement 7" Blade - 4 Teeth	185	30	4	12	\$131.89
OX-PCD-230	5060242335563	Ultimate Fibre Cement 9" Blade - 6 Teeth	230	22.2	4	12	\$239.80

Other features include:

- Thin kerf blade for minimal dust
- Ground hardened plate for smooth cut
- Cuts up to 9,000 feet of fibre cement
- Polycrystalline diamond tipped teeth
- Laser cut body, stronger tooth attachment and greater accuracy

Ground & hardened plate for smooth cut

Polycrystalline diamond tipped teeth

Thin kerf

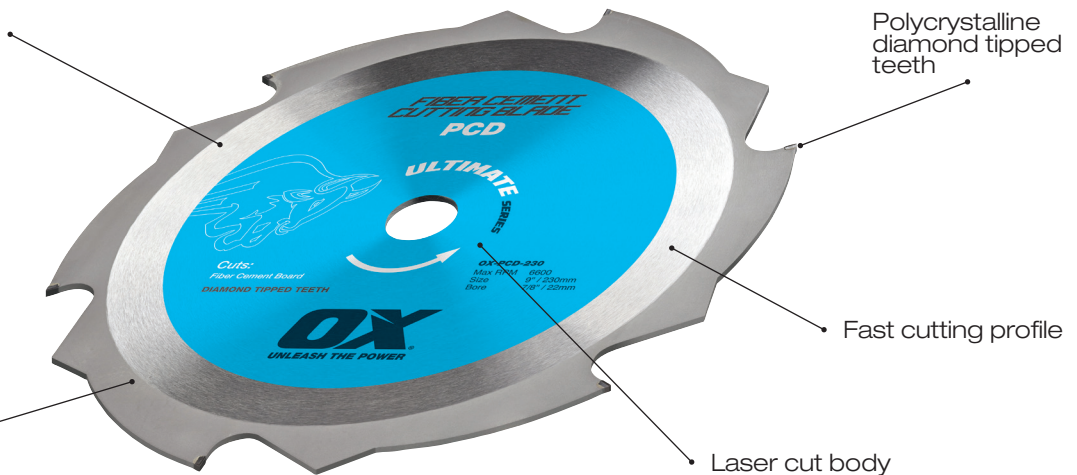

Fast cutting profile

Laser cut body



ULTIMATE UMB DUCTILE IRON BLADE

Suitable for hand held saws. Cuts ductile iron pipe, cast iron, rebar, steel, fiberglass, plastic pipe, concrete. Vacuum brazed centreplate for side clearance & protection.

Product code	Barcode	Diameter (in)	Bore (mm)	RPM	Inner Qty	Outer Qty	List Price
OX-UMB-14	9341231031106	14	25.4/20	5400	N/A	5	\$406.69
OX-UMB-16	9341231032783	16	25.4/20	3800	N/A	5	\$483.63



PRO PMT ELECTROPLATED MARBLE

Electroplated diamond blade for fine cutting of marble and glass reinforced plastic. Applications include: marble, fibreglass, plastic and glass reinforced plastic.

Product code	Barcode	Diameter (in)	Bore (mm)	RPM	Inner Qty	Outer Qty	List Price
OX-PMT-4	9341231004476	4	16	15180	6	12	\$38.89
OX-PMT-4.5	9341231004483	4 1/2	22.2/20	13200	6	12	\$52.64
OX-PMT-5	9341231004490	5	22.2/20	12144	6	12	\$61.60
OX-PMT-6	9341231004506	6	25.4/22.2	10120	6	12	\$79.09
OX-PMT-7	9341231004513	7	25.4/22.2	8433	6	12	\$91.74
OX-PMT-8	9341231004520	8	30/25.4	7590	6	12	\$110.66
OX-PMT-9	9341231004537	9	30/25.4	6600	6	12	\$125.18



PRO PMTV MARBLE VANITY

Electroplated diamond blade with diamond coated sides for cutting curves in marble.

Product code	Barcode	Diameter (in)	Bore (mm)	RPM	Inner Qty	Outer Qty	List Price
OX-PMTV-4.5	9341231004544	4 1/2	22.2/20	13200	N/A	6	\$149.49

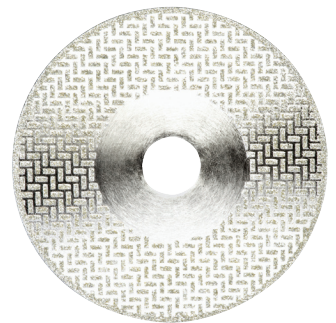



Diamond Core Drills

With a wealth of experience in all types of diamond core drilling, OX has the most complete range of products available in the market today.

NO.1 FOR DRY CORE DRILLING

OX: the home of dry core drills.

INDUSTRY BENCHMARK
The most popular.

For drilling brick and block.



NO.1 FOR WET CORE DRILLING

The professional choice for the professional contractor. UWC wet concrete drills have been tested and proven in the most demanding aggregates in the world.

For drilling reinforced concrete.



NO.1 FOR TILE DRILLING

PDD Tile Drilling revolution. Quite simply, exactly what the market has been asking for. Fast, easy to use, and completely trouble free.

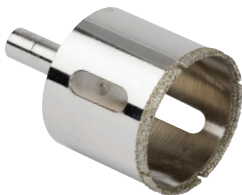

With the TTD cores for occasional users, and a choice of the PDD or UTDH cores for professional users – OX have the answers. For drilling porcelain, granite, hard natural stones and ceramics.

NO.1 DRY CORE DRILLING

The perfect start to dry core drilling, our aluminium cases are sturdier, smarter and contain more accessories than the competition. Often copied, but never surpassed, these are the cores to be seen with – and use.



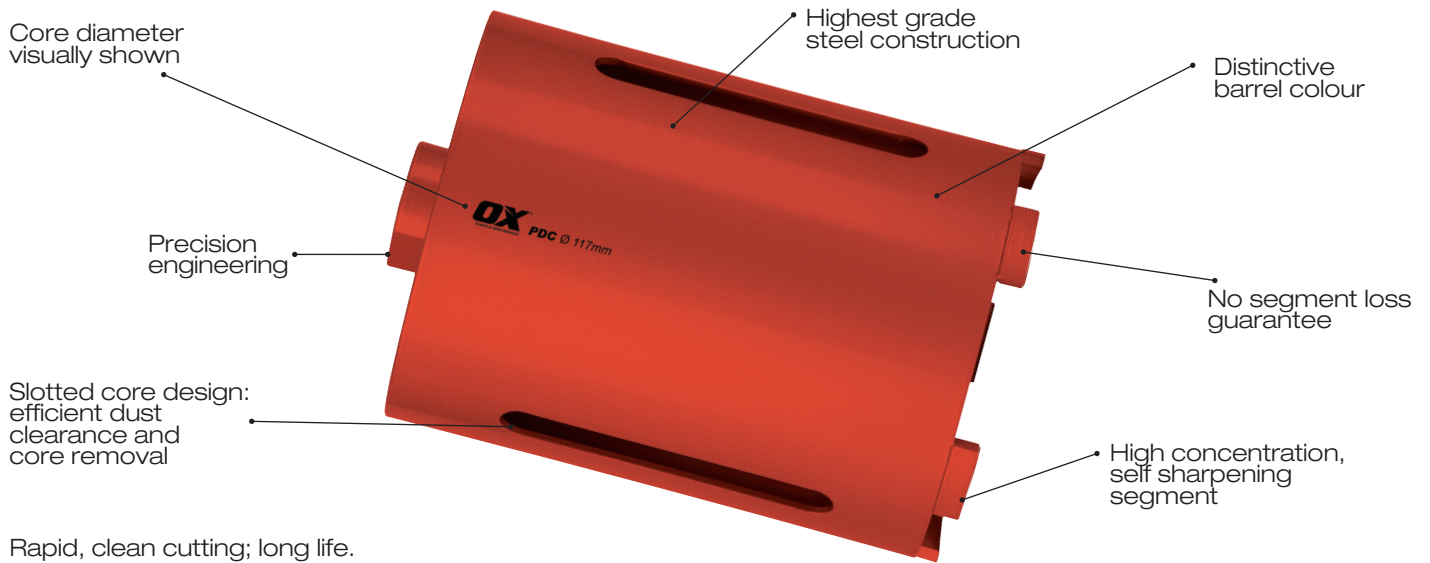

Rapid, clean cutting; long life.

PRO PDC DRY CORE DRILL

Universal dry diamond core drill in all popular plumbers sizes up to 180mm. Slotted barrel provides efficient dust clearance and ease of removing drilled core. For brick and blockwork. Applications include: medium and soft bricks, concrete blocks (lightweight and dense), abrasive concrete products. Occasional use in harder materials e.g. semi engineering bricks and clay products. Minimum drill size: 850W

Product code	Barcode	Diameter (mm)	Length (mm)	Back end	Inner Qty	Outer Qty	List Price
OX-PDC-022	9341231005176	22	300	HEX	N/A	6	\$59.00
OX-PDC-028	9341231005183	28	300	HEX	N/A	6	\$68.33
OX-PDC-032	9341231005190	32	150	1/2" BSP	N/A	6	\$66.91
OX-PDC-038	9341231005206	38	150	1/2" BSP	N/A	6	\$70.52
OX-PDC-048	9341231005213	48	150	1/2" BSP	N/A	6	\$73.07
OX-PDC-052	9341231005220	52	150	1/2" BSP	N/A	6	\$77.22
OX-PDC-065	9341231005237	65	150	1/2" BSP	N/A	4	\$83.20
OX-PDC-078	9341231005244	78	150	1/2" BSP	N/A	4	\$93.02
OX-PDC-091	9341231005251	91	150	1/2" BSP	N/A	4	\$106.49
OX-PDC-102	9341231005268	102	150	1/2" BSP	N/A	4	\$110.98
OX-PDC-107	9341231005275	107	150	1/2" BSP	N/A	4	\$116.14
OX-PDC-117	9341231005282	117	150	1/2" BSP	N/A	4	\$130.39
OX-PDC-127	9341231005299	127	150	1/2" BSP	N/A	4	\$136.55
OX-PDC-142	9341231005305	142	150	1/2" BSP	N/A	4	\$151.35
OX-PDC-152	9341231005312	152	150	1/2" BSP	N/A	4	\$168.89
OX-PDC-158	9341231005329	158	150	1/2" BSP	N/A	4	\$173.03
OX-PDC-162	9341231005336	162	150	1/2" BSP	N/A	4	\$180.26
OX-PDC-172	9341231005343	172	150	1/2" BSP	N/A	4	\$198.20
OX-PDC-182	9341231005350	182	150	1/2" BSP	N/A	4	\$221.97



PRO PCC DRY CORE CASE

FEATURES

- Everything you need to get started with dry core drilling in a sturdy aluminium case
- Contains PDC cores – 38, 52, 65, 117, 127mm
- Contains HEX & SDS adapters and extensions

Product Code	Barcode	Core Sizes	Inner Qty	Outer Qty	List Price
OX-PCC-5	9341231007309	38, 52, 65, 117, 127	1	1	\$464.55



Dry Core Drills



ULTIMATE UCC HELIX DRY CORE CASE

Everything you need to get going with dry core drilling in a sturdy, aluminium case. Revolutionary UDCL LONG LIFE dry core and HEX and SDS accessories.

Product code	Barcode	Core Sizes (mm)	Accessories	Inner Qty	Outer Qty	List Price
OX-UCC-5	9341231007323	38, 52, 65, 117 & 127	Hex & SDS Adaptors and extensions	1	1	\$580.80

Dry Core Accessories

OX dry core accessories are manufactured from the highest grade steel to ensure that they can withstand the toughest use. Zinc plating enhances the visual appearance and protects against rust without leaving oil deposits. The most complete range of accessories to cover all machinery options and personal preferences.

ADAPTORS – BSP (M)



With BSP male fitting to suit PDC cores.

Product code	Barcode	Description	Inner Qty	Outer Qty	List Price
OX-JX01	9341231012518	HEX ADAPTOR ONLY	N/A	6	\$17.00
OX-JX31	9341231012525	HEX 10" LONG ADAPTOR	N/A	6	\$33.32
OX-JS01	9341231012532	SDS (PLUS) ADAPTOR ONLY	N/A	6	\$17.00
OX-JS25	9341231012549	SDS (PLUS) 10" LONG ADAPTOR	N/A	6	\$46.90
OX-JM01	9341231012556	SDS MAX ADAPTOR ONLY	N/A	6	\$59.73
OX-JBA12	9341231012563	1/2" X 20 UN(F)-1/2" BSP(M) ADAPTOR	N/A	6	\$25.22
OX-JBA18	9341231012570	M18 X 2.5 (F) TO 1/2" BSP (M) ADAPTOR	N/A	6	\$25.22
OX-JBA58	9341231012587	1/2" X 16UN(F) TO 1/2" BSP(M) ADAPTOR	N/A	6	\$25.22

PILOTS & DRIFTS



Product code	Barcode	Description	Inner Qty	Outer Qty	List Price
OX-JB09	9341231012648	1/2" GUIDE ROD 8-1/4"	N/A	6	\$9.43
OX-JB13	9341231012655	1/2" A TAPER DRILL 8-1/4"	N/A	6	\$14.74
OX-JB05	9341231012662	DRIFT KEY	N/A	6	\$4.02

EXTENSIONS

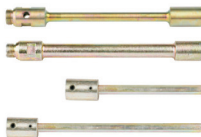

Product code	Barcode	Description	Inner Qty	Outer Qty	List Price
OX-JB26	9341231012693	1/2" BSP 10" SOLID EXTENSION + A TAPER	N/A	6	\$80.72
OX-JB25	9341231012709	1/2" BSP 10" HOLLOW EXTENSION	N/A	6	\$98.19
OX-JX15	9341231012716	HEX 6" EXTENSION (C/W ALLEN KEY)	N/A	6	\$28.72
OX-JX25	9341231012723	HEX 10" EXTENSION (C/W ALLEN KEY)	N/A	6	\$36.04

ADAPTOR PACKS



Product code	Barcode	Description	Inner Qty	Outer Qty	List Price
OX-JX03	9341231012594	HEX ADAPTOR PACK (JX01, JB09, JB05)	N/A	6	\$38.87
OX-JX03-13	9341231012600	HEX A TAPER DRILL ADAPTOR PACK (JX01, JB13, JB05)	N/A	6	\$41.11
OX-JS03	9341231012617	SDS ADAPTOR PACK (JS01, JB09, JB05)	N/A	6	\$42.87
OX-JS03-13	9341231012624	SDS A TAPER DRILL ADAPTOR PACK (JS01, JB13, JB05)	N/A	6	\$32.70
OX-JM03	9341231012631	SDS MAX ADAPTOR PACK (JM01, JB09, JB05)	N/A	6	\$64.47



Wet Core Drills

OX have a full range of wet diamond core drills for professional users, combining ultra precise engineering and high concentration, high quality diamonds. Rigorously tested in the toughest of aggregates.

ULTIMATE UWC 1-1/4" UNC WET CORE

ULTIMATE wet diamond core drill for professional rig mounted use. 450mm drilling length. 10mm segment height. Applications include: flint and limestone aggregate concrete; light to medium reinforced concrete; universal building products.

Product code	Barcode	Diameter (mm)	Length (mm)	Back end	Inner Qty	Outer Qty	List Price
OX-UWC014-450	9341231005749	14	450	1 1/4" UNC	N/A	6	\$92.63
OX-UWC016-450	9341231005756	16	450	1 1/4" UNC	N/A	6	\$107.55
OX-UWC018-450	9341231005763	18	450	1 1/4" UNC	N/A	6	\$119.08
OX-UWC020-450	9341231005770	20	450	1 1/4" UNC	N/A	6	\$119.36
OX-UWC022-450	9341231005787	22	450	1 1/4" UNC	N/A	6	\$128.21
OX-UWC024-450	9341231001352	24	450	1 1/4" UNC	N/A	6	\$131.45
OX-UWC025-450	9341231005794	25	450	1 1/4" UNC	N/A	6	\$136.37
OX-UWC028-450	9341231005800	28	450	1 1/4" UNC	N/A	6	\$151.58
OX-UWC030-450	9341231005817	30	450	1 1/4" UNC	N/A	6	\$117.72
OX-UWC032-450	9341231005824	32	450	1 1/4" UNC	N/A	6	\$118.73
OX-UWC036-450	9341231005831	36	450	1 1/4" UNC	N/A	6	\$119.17
OX-UWC040-450	9341231005848	40	450	1 1/4" UNC	N/A	6	\$119.46
OX-UWC045-450	9341231005855	45	450	1 1/4" UNC	N/A	6	\$121.07
OX-UWC052-450	9341231005879	52	450	1 1/4" UNC	N/A	4	\$123.15
OX-UWC056-450	9341231005886	56	450	1 1/4" UNC	N/A	4	\$152.19
OX-UWC062-450	9341231005893	62	450	1 1/4" UNC	N/A	4	\$162.91
OX-UWC065-450	9341231005909	65	450	1 1/4" UNC	N/A	4	\$182.11
OX-UWC072-450	9341231005916	72	450	1 1/4" UNC	N/A	4	\$187.88
OX-UWC076-450	9341231005923	76	450	1 1/4" UNC	N/A	4	\$203.72
OX-UWC082-450	9341231005930	82	450	1 1/4" UNC	N/A	4	\$212.47
OX-UWC087-450	9341231005947	87	450	1 1/4" UNC	N/A	4	\$202.57
OX-UWC092-450	9341231005954	92	450	1 1/4" UNC	N/A	4	\$215.42
OX-UWC102-450	9341231005961	102	450	1 1/4" UNC	N/A	4	\$230.62
OX-UWC107-450	9341231005978	107	450	1 1/4" UNC	N/A	4	\$248.23
OX-UWC112-450	9341231005985	112	450	1 1/4" UNC	N/A	4	\$259.20
OX-UWC117-450	9341231005992	117	450	1 1/4" UNC	N/A	4	\$276.16
OX-UWC122-450	9341231006005	122	450	1 1/4" UNC	N/A	4	\$279.35
OX-UWC127-450	9341231006012	127	450	1 1/4" UNC	N/A	4	\$302.78
OX-UWC132-450	9341231006029	132	450	1 1/4" UNC	N/A	4	\$314.20
OX-UWC142-450	9341231006036	142	450	1 1/4" UNC	N/A	4	\$325.82
OX-UWC152-450	9341231006043	152	450	1 1/4" UNC	N/A	4	\$335.12
OX-UWC162-450	9341231006050	162	450	1 1/4" UNC	N/A	4	\$351.73
OX-UWC172-450	9341231006067	172	450	1 1/4" UNC	N/A	4	\$418.88
OX-UWC182-450	9341231006074	182	450	1 1/4" UNC	N/A	4	\$457.99
OX-UWC200-450	9341231006081	200	450	1 1/4" UNC	N/A	4	\$520.91
OX-UWC225-450	9341231012952	225	450	1 1/4" UNC	N/A	4	\$704.18
OX-UWC250-450	9341231020391	250	450	1 1/4" UNC	N/A	4	\$817.80
OX-UWC300-450	9341231020407	300	450	1 1/4" UNC	N/A	4	\$1084.33
OX-UWC350-450	9341231020414	350	450	1 1/4" UNC	N/A	4	\$1198.08
OX-UWC400-450	9341231020421	400	450	1 1/4" UNC	N/A	4	\$1300.30



WET CORE ACCESSORIES

Tough, durable adaptors and extensions for wet core drilling.

Product code	Barcode	Description	Inner Qty	Outer Qty	List Price
OX-JN55	9341231011771	1/2" BSP(M) - 1/2" BSP(M) ADAPTOR	N/A	6	\$18.05
OX-JN56	9341231011788	1/2" BSP(F) - 1/2" BSP(F) ADAPTOR	N/A	6	\$24.55
OX-JN65	9341231011795	1/2" BSP(M) - 1 1/4" UNC(M) ADAPTOR	N/A	6	\$60.63
OX-JN66	9341231011801	1/2" BSP(F) - 1 1/4" UNC(F) ADAPTOR	N/A	6	\$60.63
OX-JNHAD3	9341231011818	1/2" BSP(F) - HILTI DD100/130 ADAPTOR	N/A	6	\$105.41
OX-JN25	9341231011825	1/2" BSP 250mm HOLLOW EXTENSION	N/A	6	\$54.30
OX-JN20	9341231011832	1 1/4" UNC 200mm HOLLOW EXTENSION	N/A	6	\$54.30
OX-JN30	9341231011749	1 1/4" UNC 300mm HOLLOW EXTENSION	N/A	6	\$64.31





TRADE TTD DIAMOND HOLESAW



Fast, fine cutting of marble, ceramics and stone. Low cost for the occasional user. Straight shank for use in 3 jaw chucks. Recommended for use with water feed via JPX-KIT and guide.

Product code	Barcode	Diameter (mm)	Inner Qty	Outer Qty	List Price
OX-TTD-06	9341231006319	6	N/A	6	\$9.46
OX-TTD-08	9341231006326	8	N/A	6	\$10.99
OX-TTD-10	9341231006333	10	N/A	6	\$12.38
OX-TTD-13	9341231006340	13	N/A	6	\$22.02
OX-TTD-18	9341231006357	18	N/A	6	\$24.86
OX-TTD-20	9341231006364	20	N/A	6	\$26.82
OX-TTD-25	9341231016371	25	N/A	6	\$33.52
OX-TTD-27	9341231016388	27	N/A	6	\$36.27
OX-TTD-30	9341231006395	30	N/A	6	\$40.67
OX-TTD-32	9341231006401	32	N/A	6	\$42.87
OX-TTD-36	9341231006418	36	N/A	6	\$48.80
OX-TTD-45	9341231016432	45	N/A	6	\$55.84
OX-TTD-51	9341231016449	51	N/A	4	\$63.09
OX-TTD-54	9341231016456	54	N/A	4	\$66.39
OX-TTD-63	9341231016463	63	N/A	4	\$75.46
OX-TTD-67	9341231016470	67	N/A	4	\$83.09
OX-TTD-73	9341231016487	73	N/A	4	\$90.13
OX-TTD-83	9341231016494	83	N/A	4	\$102.88
OX-TTD-86	9341231016500	86	N/A	4	\$106.39
OX-TTD-90	9341231016517	90	N/A	4	\$111.01
OX-TTD-95	9341231016524	95	N/A	4	\$120.60
OX-TTD-100	9341231016531	100	N/A	4	\$123.77
OX-TTD-110	9341231016548	110	N/A	4	\$145.09
OX-TTD-115	9341231016555	115	N/A	4	\$155.64
OX-TTD-120	9341231016562	120	N/A	4	\$163.11

PRO PDD TILE DRILL



Fast drilling, long life diamond drills supplied with unique water container for accurate positioning and cooling of the diamond tip. Superfast drilling and core ejection. Quick change 6.3 standard hex shank. Precision drilling.

Product code	Barcode	Diameter Metric (mm)	Inner Qty	Outer Qty	List Price
OX-PDD-05	9341231007170	5	N/A	6	\$39.00
OX-PDD-06	9341231007187	6	N/A	6	\$42.54
OX-PDD-07	9341231007194	7	N/A	6	\$48.62
OX-PDD-08	9341231007200	8	N/A	6	\$52.09
OX-PDD-10	9341231007224	10	N/A	6	\$57.81
OX-PDD-12	9341231007231	12	N/A	6	\$62.83
OX-PDD-15	9341231007248	15	N/A	6	\$66.53
OX-PDD-20	9341231007255	20	N/A	6	\$74.67
OX-PDD-25	9341231007262	25	N/A	6	\$83.49
OX-PDD-35	9341231007279	35	N/A	6	\$101.42

Applications include: GUARANTEED TO DRILL ALL TILES, porcelain, ceramics, granite, glass, quarry, everything!

JP WATER SWIVEL

Holesaw accessory options for accurate positioning and water cooling.

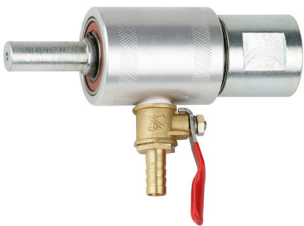

Product code	Barcode	Description	Inner Qty	Outer Qty	List Price
JP35	9341231036194	1/2" BSP(F) - Straight Shank Water Swivel	N/A	6	\$185.13



ULTIMATE UTDT WET DIAMOND HOLESAW - 1/2" BSP (M)

Product code	Barcode	Diameter (mm)	Length (mm)	Back end	Inner Qty	Outer Qty	List Price
OX-UTDT-06	9341231006838	6	40	1/2" BSP	N/A	6	\$75.85
OX-UTDT-08	9341231006845	8	40	1/2" BSP	N/A	6	\$79.13
OX-UTDT-10	9341231006852	10	40	1/2" BSP	N/A	6	\$86.17
OX-UTDT-12	9341231006869	12	40	1/2" BSP	N/A	6	\$96.28
OX-UTDT-16	9341231020773	16	40	1/2" BSP	N/A	6	\$119.14
OX-UTDT-20	9341231020780	20	40	1/2" BSP	N/A	6	\$126.96
OX-UTDT-22	9341231006876	22	40	1/2" BSP	N/A	6	\$128.79
OX-UTDT-25	9341231016883	25	40	1/2" BSP	N/A	6	\$133.00
OX-UTDT-28	9341231016890	28	40	1/2" BSP	N/A	6	\$148.39
OX-UTDT-30	9341231016906	30	40	1/2" BSP	N/A	6	\$165.75
OX-UTDT-32	9341231006913	32	40	1/2" BSP	N/A	6	\$171.47
OX-UTDT-36	9341231016920	36	40	1/2" BSP	N/A	6	\$179.16
OX-UTDT-40	9341231006937	40	40	1/2" BSP	N/A	6	\$201.15
OX-UTDT-45	9341231006944	45	40	1/2" BSP	N/A	6	\$209.94
OX-UTDT-52	9341231006951	52	40	1/2" BSP	N/A	4	\$192.01
OX-UTDT-56	9341231006968	56	40	1/2" BSP	N/A	4	\$207.69
OX-UTDT-62	9341231006975	62	40	1/2" BSP	N/A	4	\$223.36
OX-UTDT-65	9341231006982	65	40	1/2" BSP	N/A	4	\$248.82
OX-UTDT-72	9341231006999	70	40	1/2" BSP	N/A	4	\$262.54
OX-UTDT-76	9341231007002	76	40	1/2" BSP	N/A	4	\$277.23
OX-UTDT-82	9341231007019	82	40	1/2" BSP	N/A	4	\$293.89
OX-UTDT-87	9341231007026	87	40	1/2" BSP	N/A	4	\$321.32
OX-UTDT-92	9341231007033	92	40	1/2" BSP	N/A	4	\$351.10
OX-UTDT-102	9341231007040	102	40	1/2" BSP	N/A	4	\$436.36
OX-UTDT-107	9341231007057	107	40	1/2" BSP	N/A	4	\$441.86
OX-UTDT-112	9341231007064	112	40	1/2" BSP	N/A	4	\$449.56
OX-UTDT-117	9341231007071	117	40	1/2" BSP	N/A	4	\$477.04
OX-UTDT-122	9341231007088	122	40	1/2" BSP	N/A	4	\$505.38



ULTIMATE UTDH WET DIAMOND HOLESAW - HEXSHANK

Product code	Barcode	Diameter (mm)	Length (mm)	Shank (mm)	Inner Qty	Outer Qty	List Price
OX-UTDH-06	9341231020797	6	40	10	N/A	6	\$68.29
OX-UTDH-08	9341231020803	8	40	10	N/A	6	\$74.31
OX-UTDH-10	9341231020810	10	40	10	N/A	6	\$78.71
OX-UTDH-12	9341231020827	12	40	12	N/A	6	\$89.03
OX-UTDH-16	9341231020834	16	40	12	N/A	6	\$98.31
OX-UTDH-20	9341231020841	20	40	12	N/A	6	\$111.01
OX-UTDH-22	9341231020858	22	40	12	N/A	6	\$114.31
OX-UTDH-25	9341231020865	25	40	12	N/A	6	\$117.61
OX-UTDH-28	9341231020872	28	40	12	N/A	6	\$135.20
OX-UTDH-30	9341231020889	30	40	12	N/A	6	\$157.62
OX-UTDH-32	9341231020896	32	40	12	N/A	6	\$163.78
OX-UTDH-36	9341231020902	36	40	12	N/A	6	\$171.47
OX-UTDH-40	9341231020912	40	40	12	N/A	6	\$179.16
OX-UTDH-45	9341231020926	45	40	12	N/A	6	\$187.96
OX-UTDH-52	9341231020933	52	40	12	N/A	4	\$170.46
OX-UTDH-56	9341231020940	56	40	12	N/A	4	\$185.14
OX-UTDH-62	9341231020957	62	40	12	N/A	4	\$197.88
OX-UTDH-65	9341231020964	65	40	12	N/A	4	\$211.21
OX-UTDH-72	9341231020971	70	40	12	N/A	4	\$217.09
OX-UTDH-76	9341231020988	76	40	12	N/A	4	\$230.62
OX-UTDH-82	9341231020995	82	40	12	N/A	4	\$251.97
OX-UTDH-87	9341231021008	87	40	12	N/A	4	\$271.36
OX-UTDH-92	9341231021015	92	40	12	N/A	4	\$325.13
OX-UTDH-102	9341231021022	102	40	12	N/A	4	\$360.53
OX-UTDH-107	9341231021039	107	40	12	N/A	4	\$384.26
OX-UTDH-112	9341231021046	112	40	12	N/A	4	\$401.19
OX-UTDH-117	9341231021053	117	40	12	N/A	4	\$424.71
OX-UTDH-122	9341231021060	122	40	12	N/A	4	\$455.28





Concreting Tools



Concreting is hard work and the OX range has been developed to stand the test of time.

Look at the detail of the products – the quality and thickness of the steel, the perfect amount of flexibility, the positioning of the handles, the quality of the riveting – the complete finish.

A tough range of trowels to cement your reputation.

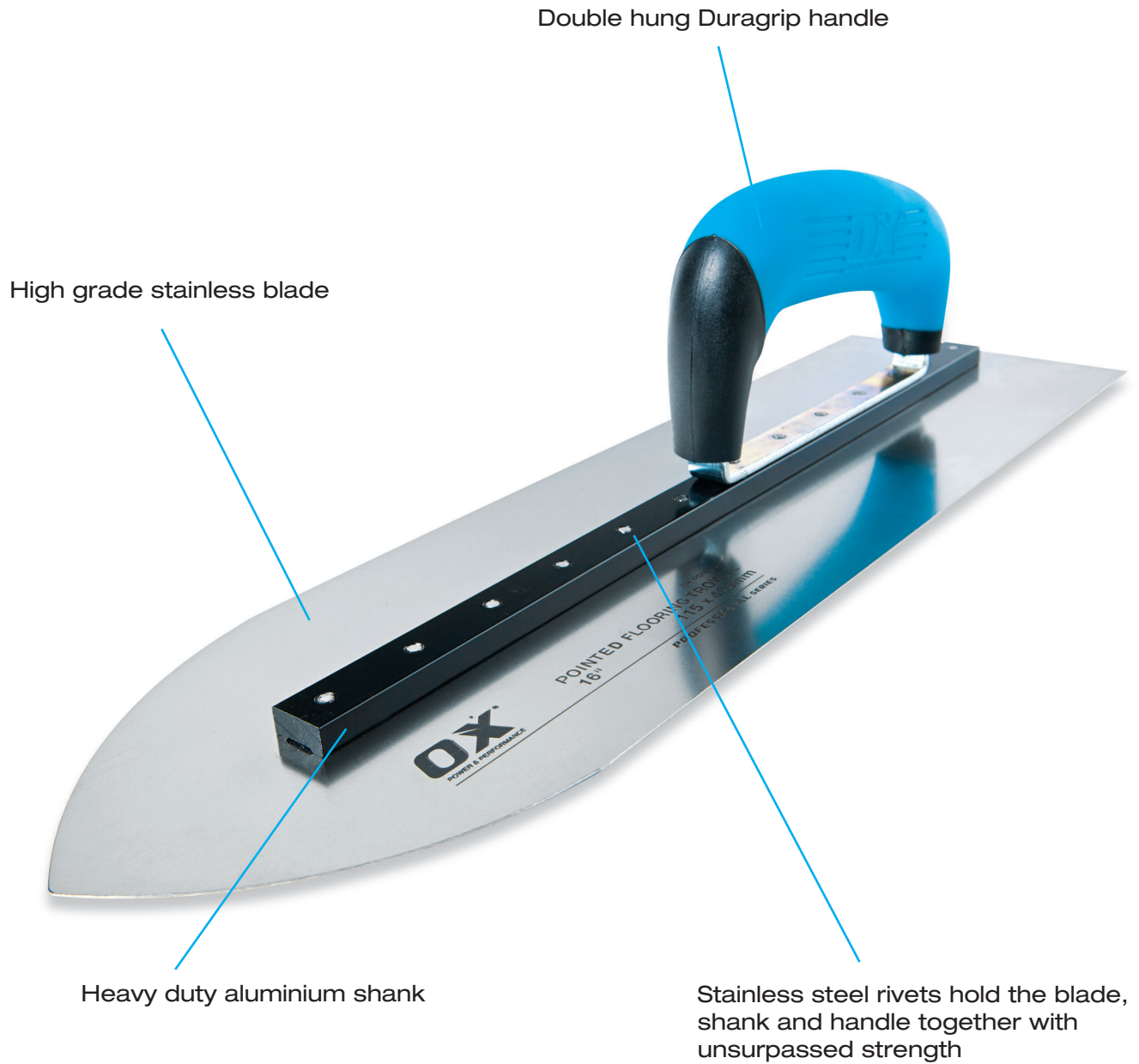



TRADE TIE WIRE REEL



FEATURES

- Fits any standard belt
- Suits all types of tie wire
- Left or right hand use
- Cast aluminium construction

Product Code	Barcode	Suits	Inner Qty	Outer Qty	List Price
OX-T299701	9341231020230	Fits any standard belt	4	12	\$60.77

TRADE WIRE TWISTER



FEATURES

- Smooth operating spiral spindle
- Reinforcing ring to prevent unnecessary wear when hook end returns
- Soft grip

Product Code	Barcode	Size	Inner Qty	Outer Qty	List Price
OX-T230231	9328217006785	12" / 310mm	4	12	\$39.35

PRO WIRE TWISTER



FEATURES

- DURAGRIP Handle
- Wear resistant bronze sleeve
- Leather re-coil 'stopper'
- Accurately machined spiral spindle

Product Code	Barcode	Size	Inner Qty	Outer Qty	List Price
OX-P230231	9341231029028	12" / 310mm	4	12	\$56.99

PRO NARROW HEAD END CUTTING NIPPER



FEATURES

- Individually hardened
- Drop forged from special tool steel
- PVC DURAGRIP handles
- Max cut thickness 3.2mm / Hardness (Jaw) 61 HRC – OX-P230322
- Max cut thickness 3.5mm / Hardness (Jaw) 61 HRC – OX-P230325
- Max cut thickness 3.5mm / Hardness (Jaw) 61 HRC – OX-P230328

Product Code	Barcode	Length	Inner Qty	Outer Qty	List Price
OX-P230322	9341231013553	8" / 220mm	6	24	\$43.74
OX-P230325	9341231010743	10" / 250mm	6	24	\$48.74
OX-P230328	9341231013560	11" / 280mm	6	24	\$52.77



PRO WIDE HEAD END CUTTING NIPPER

FEATURES

- Individually hardened
- Drop forged from special tool steel
- PVC DURAGRIP handles
- Max cut thickness 3.5mm / Hardness (Jaw) 60 HRC – OX-P230418
- Max cut thickness 3.8mm / Hardness (Jaw) 60 HRC – OX-P230420

Product Code	Barcode	Size	Inner Qty	Outer Qty	List Price
OX-P230418	9341231013546	7" / 180mm	6	24	\$51.08
OX-P230420	9341231010750	8" / 200mm	6	24	\$52.05



PRO END CUTTING NIPPER

FEATURES

- Individually hardened
- Drop forged from special tool steel
- PVC DURAGRIP handles
- Max cut thickness 3.8mm / Hardness (Jaw) 60 HRC

Product Code	Barcode	Size	Inner Qty	Outer Qty	List Price
OX-P230520	9341231013584	8" / 200mm	6	24	\$48.74



ULTIMATE WIDE HEAD END CUTTING NIPPER

FEATURES

- Professional quality
- Individually hardened
- Drop forged from special tool steel
- PVC DURAGRIP handles
- Max cut thickness 3.5mm / Hardness (Jaw) 60 HRC – OX-U230418
- Max cut thickness 3.8mm / Hardness (Jaw) 60 HRC – OX-U230420

Product Code	Barcode	Size	Inner Qty	Outer Qty	List Price
OX-U230418	9341231034947	7" / 180mm	N/A	6	\$53.16
OX-U230420	9341231034954	8" / 200mm	N/A	6	\$54.14



ULTIMATE END CUTTING NIPPER

FEATURES

- Professional quality
- Individually hardened
- Drop forged from special tool steel
- PVC DURAGRIP handles
- Max cut thickness 3.2mm / Hardness (Jaw) 61 HRC – OX-U230322
- Max cut thickness 3.5mm / Hardness (Jaw) 61 HRC – OX-U230325
- Max cut thickness 3.5mm / Hardness (Jaw) 61 HRC – OX-U230328

Product Code	Barcode	Size	Inner Qty	Outer Qty	List Price
OX-U230322	9341231034916	8" / 220mm	N/A	6	\$42.35
OX-U230325	9341231034923	10" / 250mm	N/A	6	\$51.61
OX-U230328	9341231034930	11" / 280mm	N/A	6	\$57.63





PRO BOLT CUTTERS

FEATURES

- Heat treated alloy jaws - fully adjustable and replaceable
- Rated to cut HRC40



Product Code	Barcode	Size	Inner Qty	Outer Qty	List Price
OX-P230118	9341231021343	18" / 450mm	2	4	\$65.89
OX-P230124	9341231021350	24" / 600mm	2	4	\$88.51
OX-P230130	9341231021367	30" / 750mm	2	4	\$113.87
OX-P230136	9341231021374	36" / 900mm	2	4	\$159.81
OX-P230142	9341231021381	42" / 1050mm	2	4	\$300.39

PRO REPLACEMENT BOLT CUTTER HEAD

FEATURES

- Suits OX boltcutters
- Heat treated alloy jaws
- Rated to cut HRC40



Product Code	Barcode	Suits	Inner Qty	Outer Qty	List Price
OX-P239930	9341231021398	OX-P230130 (750mm)	2	4	\$69.06
OX-P239936	9341231021404	OX-P230136 (900mm)	2	4	\$84.80
OX-P239942	9341231021411	OX-P230142 (1050mm)	2	4	\$166.84

PRO FORGED BOLT CUTTERS

FEATURES

- Alloy steel blade
- Drop forged handle
- Rated to cut HRC40



Product Code	Barcode	Length	Inner Qty	Outer Qty	List Price
OX-P230518	9341231024337	18" / 450mm	2	4	\$70.81
OX-P230524	9341231024344	24" / 600mm	2	4	\$94.29
OX-P230530	9341231024351	30" / 750mm	2	4	\$117.62
OX-P230536	9341231024368	36" / 900mm	2	4	\$176.37

TRADE REBAR BENDER/CUTTER

FEATURES

- Jaws made of high carbon alloy tool steel - HRC54
- Cuts and bends grade 60 rebar
- Can be bolted to the floor
- Bends 90° and 180°
- Heavy duty
- Max cut 16mm Ø



Product Code	Barcode	Length	Inner Qty	Outer Qty	List Price
OX-T230613	9341231024412	52" / 1320mm	1	1	\$513.55



TRADE LIGHTWEIGHT ALUMINIUM CONCRETE RAKE

FEATURES

- Lightweight for ease of use
- Extruded rake plate
- 45 degree edge angle
- 1500mm long handle with soft grip

Product Code	Barcode	Size	Inner Qty	Outer Qty	List Price
OX-T016301	9341231024443	100 x 500mm	N/A	4	\$47.73

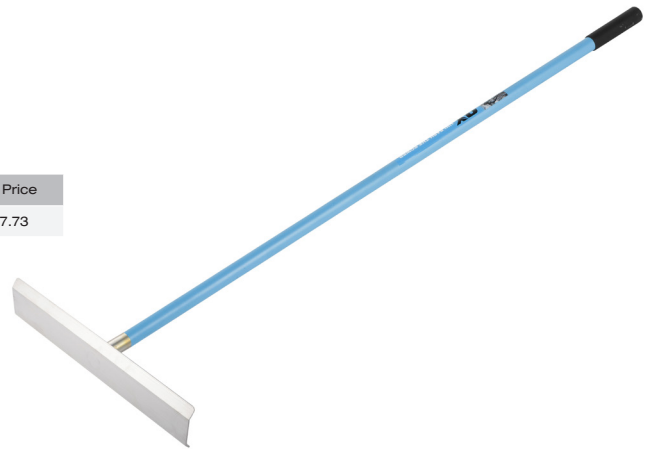

PRO ALUMINIUM CONCRETE RAKE

FEATURES

- 1500mm long handle with soft grip
- Braced for additional strength
- Aluminium construction - powder coated

Product Code	Barcode	Size	Inner Qty	Outer Qty	List Price
OX-P016302	9341231024450	100 x 500mm	4	48	\$47.73

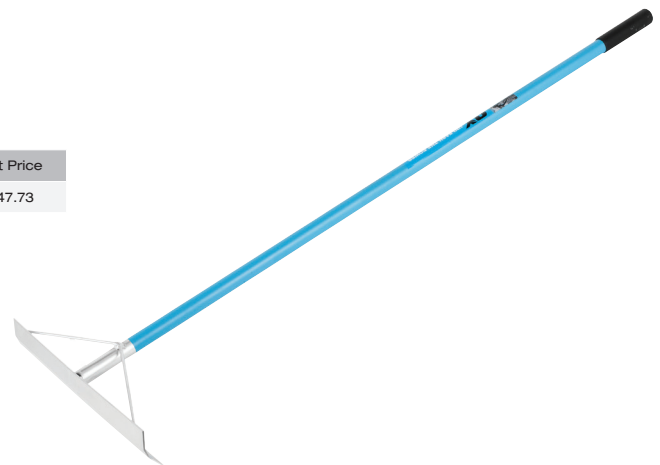

PRO ALUMINIUM CONCRETE RAKE - WITH HOOK

FEATURES

- Braced for additional strength
- With 8mm diameter hook for lifting rebar
- 1500mm long handle with soft grip

Product Code	Barcode	Size	Inner Qty	Outer Qty	List Price
OX-P016303	9341231024467	100 x 500mm	4	48	\$53.45

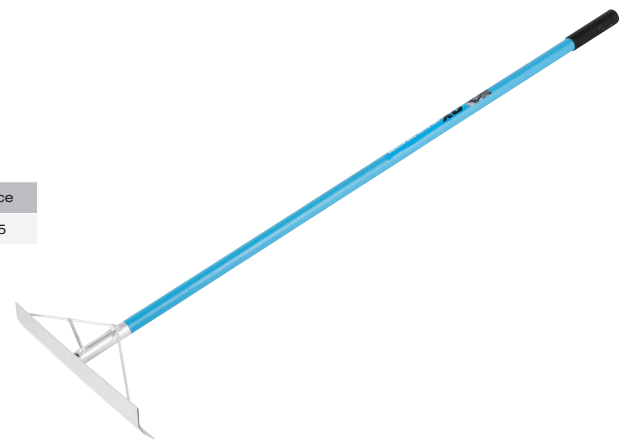



PRO STRAIGHT EDGE

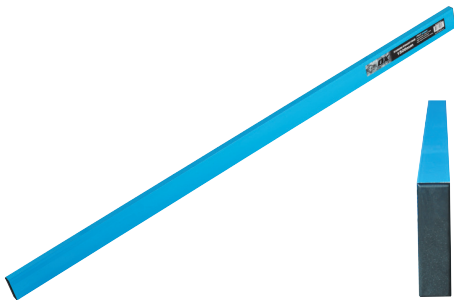

FEATURES

- High quality extruded aluminium
- Easy to clean powder-coated finish
- Fluted profile - easy to grip extrusion design

Product Code	Barcode	Size (W x H x L)	Inner Qty	Outer Qty	List Price
OX-P021612	9341231000386	20 x 70 x 1200mm	N/A	4	\$35.21
OX-P021615	9341231000393	20 x 70 x 1500mm	N/A	4	\$41.17
OX-P021618	9341231000409	20 x 70 x 1800mm	N/A	4	\$50.05
OX-P021621	9341231000416	20 x 70 x 2100mm	N/A	4	\$57.14
OX-P021624	9341231000423	20 x 70 x 2400mm	N/A	4	\$65.66
OX-P021627	9341231000430	20 x 70 x 2700mm	N/A	4	\$72.96
OX-P021630	9341231000447	20 x 70 x 3000mm	N/A	4	\$80.46
OX-P021636	9341231000454	20 x 70 x 3600mm	N/A	4	\$94.17

PRO STRAIGHT EDGE – HEAVY DUTY

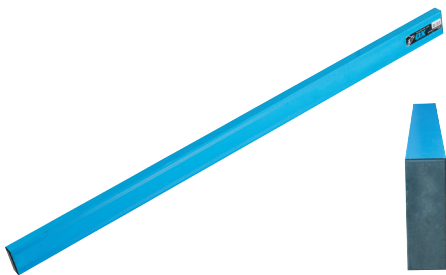

FEATURES

- 15mm THICKER than the standard straight edge
- Fluted profile - easy to grip extrusion design
- High quality extruded aluminium
- Easy to clean powder-coated finish

Product Code	Barcode	Size	Inner Qty	Outer Qty	List Price
OX-P021712	9341231000843	30 x 85 x 1200mm	N/A	4	\$102.08
OX-P021715	9341231000850	30 x 85 x 1500mm	N/A	4	\$110.57
OX-P021718	9341231000867	30 x 85 x 1800mm	N/A	4	\$85.81
OX-P021721	9341231000874	30 x 85 x 2100mm	N/A	4	\$100.67
OX-P021724	9341231000881	30 x 85 x 2400mm	N/A	4	\$125.52
OX-P021727	9341231000898	30 x 85 x 2700mm	N/A	4	\$132.72
OX-P021730	9341231000904	30 x 85 x 3000mm	N/A	4	\$154.64
OX-P021736	9341231000911	30 x 85 x 3600mm	N/A	4	\$185.64

PRO STRAIGHT EDGE SPARE PART



FEATURES

- High quality plastic moulded end caps
- End Cap Set – (2pc)

Product Code	Barcode	Suits	Inner Qty	Outer Qty	List Price
OX-P029801	9341231021718	Straight Edge	N/A	6	\$10.74
OX-P029802	9341231021725	H/D Straight Edge	N/A	6	\$13.42



PRO CLAMPED HANDLE SCREED

FEATURES

- Heavy duty structural alloy
- Reversible clamped handle
- Ergonomic grip handle
- Easy to clean powder-coated finish
- Internal strength support bars
- Cutting and pushing edge positioned for comfort
- Profile size 40 x 50mm

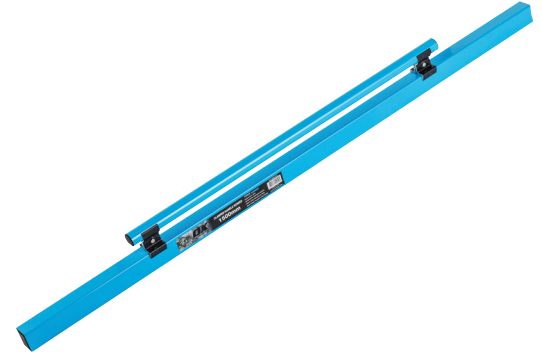

Product Code	Barcode	Length	Inner Qty	Outer Qty	List Price
OX-P021412	9341231000188	1200mm	N/A	4	\$53.92
OX-P021415	9341231000195	1500mm	N/A	4	\$57.84
OX-P021418	9341231000201	1800mm	N/A	4	\$69.76
OX-P021421	9341231000218	2100mm	N/A	4	\$77.92
OX-P021424	9341231000225	2400mm	N/A	4	\$84.62
OX-P021427	9341231000232	2700mm	N/A	4	\$93.29
OX-P021430	9341231000249	3000mm	N/A	4	\$102.23
OX-P021436	9341231000256	3600mm	N/A	4	\$123.52
OX-P021442*	9341231000263	4200mm	N/A	4	\$175.03
OX-P021448*	9341231000270	4800mm	N/A	4	\$186.30

*Denotes sizes that include 2 x handles

PRO CLAMPED HANDLE SCREED WITH VIAL

FEATURES

- Heavy duty structural alloy
- Reversible clamped handle
- Ergonomic grip handle
- Easy to clean powder-coated finish
- Internal strength support bars
- Cutting and pushing edge positioned for comfort
- Profile size 40 x 50mm
- Built in vial for easy levelling



Product Code	Barcode	Length	Inner Qty	Outer Qty	List Price
OX-P021312	9341231000973	1200mm	N/A	4	\$72.26
OX-P021315	9341231000980	1500mm	N/A	4	\$79.04
OX-P021318	9341231000997	1800mm	N/A	4	\$86.94
OX-P021321	9341231001000	2100mm	N/A	4	\$94.29
OX-P021324	93412310001017	2400mm	N/A	4	\$102.01
OX-P021327	9341231001024	2700mm	N/A	4	\$112.19
OX-P021330	9341231001031	3000mm	N/A	4	\$118.91
OX-P021336	9341231001048	3600mm	N/A	4	\$136.55



PRO SCREED SPARE PART



FEATURES

- OX-P021901 suits clamped handle screed
- OX-P021902 suits clamped handle screed with vial

Product Code	Barcode	Description	Inner Qty	Outer Qty	List Price
OX-P021901	9341231021640	Handle	N/A	4	\$36.63
OX-P021902	9341231021657	Handle with Vial	N/A	4	\$67.58

- OX-P021904 suits clamped screed handle

Product Code	Barcode	Description	Inner Qty	Outer Qty	List Price
OX-P021904	9341231021671	Clamp Set - (2)	N/A	6	\$15.60

- OX-P021905 suits fixed screed handle
- OX-P021906 suits clamped screed
- OX-P021907 suits screed handle

Product Code	Barcode	Description	Inner Qty	Outer Qty	List Price
OX-P021905	9341231021688	End Cap Set - (2)	N/A	6	\$21.12
OX-P021906	9341231021695	End Cap Set - (2)	N/A	6	\$12.38
OX-P021907	9341231021701	End Cap Set - (2)	N/A	6	\$31.80

PRO ALUMINIUM BULLFLOAT

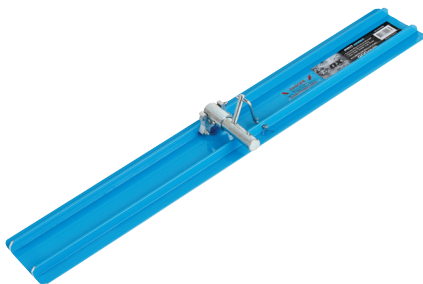

FEATURES

- Heavy duty structural alloy
- Easy to clean powder coated finish
- Extruded ribs for extra strength

Product Code	Barcode	Overall Length	Inner Qty	Outer Qty	List Price
OX-P016606	9341231000928	150 x 600mm	N/A	4	\$71.73
OX-P016609	9341231000935	150 x 900mm	N/A	4	\$84.87
OX-P016612	9341231000942	150 x 1200mm	N/A	4	\$107.98
OX-P016615	9341231000959	150 x 1500mm	N/A	4	\$130.91
OX-P016618	9341231000966	150 x 1800mm	N/A	4	\$147.59

PRO ALUMINIUM BULLFLOAT – MILL FINISH



FEATURES

- Heavy duty structural alloy
- Mill finish for perfect finishing
- Extruded ribs for extra strength

Product Code	Barcode	Overall Length	Inner Qty	Outer Qty	List Price
OX-P016406	9341231024481	150 x 600mm	N/A	4	\$65.15
OX-P016409	9341231024498	150 x 900mm	N/A	4	\$76.78
OX-P016412	9341231024504	150 x 1200mm	N/A	4	\$98.23
OX-P016415	9341231024511	150 x 1500mm	N/A	4	\$122.93
OX-P016418	9341231024528	150 x 1800mm	N/A	4	\$136.71



PRO REPLACEMENT TILT MECHANISM

FEATURES

- Suits the powder-coated and milled finished bullfloats



Product Code	Barcode	Inner Qty	Outer Qty	List Price
OX-P029601	9341231021633	N/A	6	\$48.53

PRO TELESCOPIC HANDLE

FEATURES

- Powder coated finish
- Fluted profile
- H.D.P.E screw-lock fitting
- "T" section "Twist Stop" extrusion design
- High quality extruded aluminium



Product Code	Barcode	Size	Inner Qty	Outer Qty	List Price
OX-P016524	9341231000829	Length 1300 - 2400mm	4	12	\$59.91
OX-P016550	9341231000836	Length 2700 - 5000mm	4	12	\$76.09

PRO TELESCOPIC HANDLE ADAPTOR

FEATURES

- Suits OX-P016524 & OX-P016550



Product Code	Barcode	Suits	Inner Qty	Outer Qty	List Price
OX-P409901	9341231015854	OX-P016524 & OX-P016550	6	24	\$9.85

PRO TELESCOPIC HANDLE REPLACEMENT PARTS

FEATURES

- Suits OX-P016524 and OX-P016550

Product Code	Barcode	Size	Inner Qty	Outer Qty	List Price
OX-P019710	9341231000836	Replacement Quick Release Pin	12	36	\$7.39
OX-P019501	9341231021626	Replacement Plastic Collet / End Cap	N/A	12	\$19.21





PRO CLIP TOGETHER HANDLE



FEATURES

- High quality extruded aluminium
- Snap together for fast tool changes

Product Code	Barcode	Length	Inner Qty	Outer Qty	List Price
OX-P019020	9341231024573	1800mm	4	12	\$38.67
OX-P019024	9341231025938	2400mm	4	12	\$47.00

PRO CLIP TOGETHER HANDLE ADAPTERS

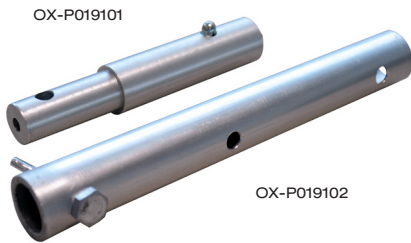

FEATURES

- High quality extruded aluminium
- Available to suit all major manufacturers

Product Code	Barcode	Size	Inner Qty	Outer Qty	List Price
OX-P019101	9341231024580	OX Male fitting	N/A	6	\$16.12
OX-P019102	9341231024597	OX Female fitting	N/A	6	\$22.72

TRADE NARROW GROOVER



FEATURES

- Carbon steel blade
- One piece ergonomic plastic handle
- Groove: Width 5/8" - 5/16" 15-8mm
Depth 1/2" 12mm (OX-T017410), 3/4" 20mm (OX-T017419)

Product Code	Barcode	Blade Size	Inner Qty	Outer Qty	List Price
OX-T017410	9341231010507	5½ x 3" / 140 x 75mm	4	12	\$19.51
OX-T017419	9341231010514	6½ x 3" / 165 x 75mm	4	12	\$19.51

TRADE WIDE GROOVER



FEATURES

- Carbon steel blade
- One piece ergonomic plastic handle
- Groove: Width 5/8" - 5/16" 15-8mm
Depth 1/2" 12mm (OX-T017512), 3/4" 20mm (OX-T017520)

Product Code	Barcode	Blade Size	Inner Qty	Outer Qty	List Price
OX-T017512	9341231010521	6¾ x 3" / 170 x 150mm	4	12	\$26.82
OX-T017520	9341231010538	6¾ x 3" / 170 x 150mm	4	12	\$26.82



PRO NARROW GROOVER

FEATURES

- High grade stainless steel blade
- Reversible DURAGRIP handle
- Groove: Width 5/8" - 5/16" 15-8mm
Depth 3/8" 10mm (OX-P014210), 3/4" 19mm (OX-P014219)

Product Code	Barcode	Blade Size	Inner Qty	Outer Qty	List Price
OX-P014210	9341231011269	3 x 7" / 75 x 180mm	4	12	\$39.39
OX-P014219	9341231011276	3 x 7" / 75 x 180mm	4	12	\$41.57



PRO WIDE GROOVER

FEATURES

- High grade stainless steel blade
- Reversible DURAGRIP handle
- Groove: Width 5/8" - 5/16" 15-8mm
Depth 1/2" 12mm (OX-P014312), 25/32" 20mm (OX-P014320)

Product Code	Barcode	Blade Size	Inner Qty	Outer Qty	List Price
OX-P014312	9341231011269	6 x 7" / 155 x 180mm	4	12	\$50.13
OX-P014320	9341231011276	6 x 7" / 155 x 180mm	4	12	\$52.14



PRO GROOVER

FEATURES

- High grade stainless steel blade
- Reversible DURAGRIP handle
- Groove: Width 3/16" 4.8mm
Depth 3/8" 10mm

Product Code	Barcode	Blade Size	Inner Qty	Outer Qty	List Price
OX-P012510	9341231021428	3 1/2 x 6" / 90 x 150mm	4	12	\$34.56



TRADE NARROW EDGER

FEATURES

- Carbon steel blade
- One piece ergonomic plastic handle
- Blade size: 6 x 3" / 150 x 75mm

Product Code	Barcode	Radius / Depth	Inner Qty	Outer Qty	List Price
OX-T016805	9341231010323	5mm, 12mm	4	12	\$13.06
OX-T016806	9341231010320	6mm, 12mm	4	12	\$13.06
OX-T016810	9341231010347	10mm, 19mm	4	12	\$13.06
OX-T016819	9341231010354	19mm, 19mm	4	12	\$13.06





TRADE MEDIUM EDGER



FEATURES

- Carbon steel blade
- One piece ergonomic plastic handle
- Blade size: 6 x 4" / 150 x 100mm

Product Code	Barcode	Radius / Depth	Inner Qty	Outer Qty	List Price
OX-T016906	9341231010361	6mm, 19mm	4	12	\$16.98
OX-T016910	9341231010378	10mm, 14mm	4	12	\$16.98

TRADE WIDE EDGER

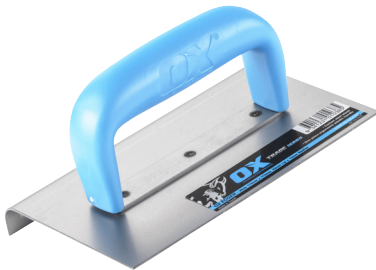

FEATURES

- Carbon steel blade
- One piece ergonomic plastic handle
- Blade size: OX-T017012 – 7 x 4¼" / 175 x 112mm
- Blade size: OX-T017020 – 8 x 5½" / 200 x 140mm
- Blade size: OX-T017025 – 7 x 4¼" / 175 x 112mm

Product Code	Barcode	Radius / Depth	Inner Qty	Outer Qty	List Price
OX-T017012	9341231010385	12mm, 22mm	4	12	\$15.11
OX-T017020	9341231010392	20mm, 19mm	4	12	\$18.16
OX-T017025	9341231010408	25mm, 19mm	4	12	\$15.11

TRADE EXTRA WIDE EDGER



FEATURES

- Carbon steel blade
- One piece ergonomic plastic handle
- Blade size: 9 x 6" / 230 x 150mm

Product Code	Barcode	Radius / Depth	Inner Qty	Outer Qty	List Price
OX-T017112	9341231010415	12mm, 24mm	4	12	\$19.64
OX-T017125	9341231010422	25mm, 24mm	4	12	\$19.64

TRADE STEP EDGER



FEATURES

- Carbon steel blade
- One piece ergonomic plastic handle
- Blade size: 6 x 3" / 150 x 75mm

Product Code	Barcode	Radius / Depth	Inner Qty	Outer Qty	List Price
OX-T017210	9341231010439	10mm, 40mm	4	12	\$13.06



PRO NARROW EDGER

FEATURES

- High grade stainless steel blade
- Rivetted handle support
- Reversible DURAGRIP handle
- Blade size: 3 x 7" / 75 x 180mm

Product Code	Barcode	Radius / Depth	Inner Qty	Outer Qty	List Price
OX-P014406	9341231011092	6mm, 12mm	4	12	\$28.08
OX-P014410	9341231011108	10mm, 19mm	4	12	\$28.67



PRO MEDIUM EDGER

FEATURES

- High grade stainless steel blade
- Rivetted handle support
- Reversible DURAGRIP handle
- Blade size: 4 x 7" / 100 x 180mm

Product Code	Barcode	Radius / Depth	Inner Qty	Outer Qty	List Price
OX-P014506	9341231011115	6mm, 14mm	4	12	\$29.25
OX-P014510	9341231011122	10mm, 14mm	4	12	\$29.25
OX-P014519	9341231011139	19mm, 19mm	4	12	\$29.50



PRO WIDE EDGER

FEATURES

- High grade stainless steel blade
- Rivetted handle support
- Reversible DURAGRIP handle
- Blade size: 5 x 7½" / 130 x 190mm

Product Code	Barcode	Radius / Depth	Inner Qty	Outer Qty	List Price
OX-P014812	9341231011146	12mm, 22mm	4	12	\$32.10
OX-P014820	9341231011153	20mm, 22mm	4	12	\$32.10
OX-P014825	9341231011160	25mm, 22mm	4	12	\$32.10



PRO EXTRA WIDE EDGER

FEATURES

- High grade stainless steel blade
- Rivetted handle support
- Reversible DURAGRIP handle
- Blade size: 5¾ x 8½" / 145 x 215mm

Product Code	Barcode	Radius / Depth	Inner Qty	Outer Qty	List Price
OX-P014910	9341231011306	10mm, 12mm	4	12	\$33.61
OX-P014912	9341231011177	12mm, 24mm	4	12	\$34.45
OX-P014916	9341231011313	16mm, 16mm	4	12	\$34.45
OX-P014925	9341231011184	25mm, 24mm	4	12	\$34.45





PRO STEP EDGER



FEATURES

- High grade stainless steel blade
- Rivetted handle support
- Reversible DURAGRIP handle
- Blade size: 4 x 7" / 100 x 180mm

Product Code	Barcode	Radius / Depth	Inner Qty	Outer Qty	List Price
OX-P015110	9341231011191	10mm, 50mm	4	12	\$31.85

PRO SAFETY STEP EDGER



FEATURES

- High grade stainless steel blade
- Reversible DURAGRIP handle - rivetted handle support
- Cuts 4 grooves while edging the step
- Blade size: 5x7" / 120 x 180mm

Product Code	Barcode	Radius / Depth	Inner Qty	Outer Qty	List Price
OX-P019312	9341231024689	10mm, 50mm	4	12	\$49.80

PRO COVING TROWEL



FEATURES

- High grade stainless steel blade
- Reversible DURAGRIP handle - rivetted handle support
- Blade size: 4 x 7" / 100 x 180mm

Product Code	Barcode	Radius / Depth	Inner Qty	Outer Qty	List Price
OX-P015010	9341231021435	4 x 7" / 100 x 180mm	4	12	\$33.29

TRADE TIMBER FLOAT



FEATURES

- Special timber blades
- One piece ergonomic plastic handle

Product Code	Barcode	Size	Inner Qty	Outer Qty	List Price
OX-T017102	9341231021992	12 x 4½" / 300 x 112mm	4	12	\$20.04
OX-T017115	9341231022005	15 x 4½" / 380 x 112mm	4	12	\$25.61
OX-T017118	9341231022012	18 x 2½" / 450 x 50mm	4	12	\$19.51
OX-T017124	9341231022029	24 x 2½" / 600 x 60mm	4	12	\$21.62



PRO TIMBER FLOAT

FEATURES

- DURAGRIP 'High lift' handle design
- High quality hardwood blade
- Special timber screws to prevent 'backing out'

Product Code	Barcode	Size	Inner Qty	Outer Qty	List Price
OX-P012212	9341231013034	4½ x 12" / 112 x 300mm	4	12	\$26.52
OX-P012215	9341231013461	4½ x 15" / 112 x 380mm	4	12	\$29.37
OX-P012218	9341231013478	4½ x 18" / 112 x 450mm	4	12	\$34.42
OX-P012318	9341231020322	2½ x 18" / 50 x 450mm	4	12	\$30.67
OX-P012324	9341231021442	2½ x 24" / 65 x 600mm	4	12	\$34.96



PRO SPINNER FLOAT

FEATURES

- High grade stainless steel blade - 'dished design'
- Reversible DURAGRIP handle

Product Code	Barcode	Size	Inner Qty	Outer Qty	List Price
OX-P014112	9341231021206	4¾ x 11½" / 120 x 290mm	4	12	\$40.58
OX-P014114	9341231021206	5¾ x 8" / 145 x 215mm	4	12	\$39.03



PRO ALL SIDES UP FLOAT

FEATURES

- High grade stainless steel blade
- Reversible DURAGRIP handle

Product Code	Barcode	Size	Inner Qty	Outer Qty	List Price
OX-P013910	9341231020452	4 x 11½" / 100 x 290mm	4	12	\$38.18
OX-P013916	9341231020469	6¼ x 8¾" / 160 x 210mm	4	12	\$39.14



PRO ALL SIDES UP FLOAT

FEATURES

- High grade stainless steel blade - flat design
- Reversible 'High lift' design DURAGRIP handle

Product Code	Barcode	Size	Inner Qty	Outer Qty	List Price
OX-P013938	9341231020476	6 x 15" / 150 x 380mm	4	12	\$44.86



PRO MAGNESIUM FLOAT – DURAGRIP HANDLE

FEATURES

- Heavy duty magnesium blade
- Bevelled ends and rounded corners
- Ergonomic DURAGRIP handle

Product Code	Barcode	Size	Inner Qty	Outer Qty	List Price
OX-P017012	9341231024900	3 x 12" / 80 x 300mm	4	12	\$35.11
OX-P017016	9341231011030	3 x 16" / 80 x 400mm	4	12	\$39.37
OX-P017020	9341231011047	3 x 20" / 80 x 500mm	4	12	\$47.20





PRO MAGNESIUM FLOAT – ROUNDED ENDS



FEATURES

- Heavy duty magnesium blade
- Ergonomic DURAGRIP handle
- Fully rounded ends helps prevent float marks

Product Code	Barcode	Size	Inner Qty	Outer Qty	List Price
OX-P400416	9341231024917	3 x 8" / 80 x 400mm	4	12	\$43.52

PRO MAGNESIUM FLOAT – WIDE BLADE



FEATURES

- Heavy duty magnesium blade
- Ergonomic DURAGRIP handle
- Wide blade wears longer

Product Code	Barcode	Size	Inner Qty	Outer Qty	List Price
OX-P400517	9341231024924	3½ x 16" / 90 x 400mm	4	12	\$46.32

TRADE POINTED FINISHING TROWEL



FEATURES

- Carbon steel blade
- One piece ergonomic plastic handle

Product Code	Barcode	Size	Inner Qty	Outer Qty	List Price
OX-T017309	9341231010446	4 x 14" / 100 x 335mm	4	12	\$29.74
OX-T017301	9341231010453	4½ x 14" / 120 x 356mm	4	12	\$31.24
OX-T017391	9341231010460	4½ x 16" / 115 x 405mm	4	12	\$33.75
OX-T017392	9341231010477	4½ x 17¾" / 115 x 450mm	4	12	\$35.16
OX-T017393	9341231010484	4½ x 19½" / 115 x 500mm	4	12	\$36.74
OX-T017365	9341231010491	4½ x 24" / 115 x 600mm	4	12	\$41.32

PRO POINTED FINISHING TROWEL



FEATURES

- High grade stainless steel blade
- Heavy duty aluminium shank
- 'Double hung' DURAGRIP handle
- Stainless steel rivets holds the blade, shank and handle together with unsurpassed strength

Product Code	Barcode	Size	Inner Qty	Outer Qty	List Price
OX-P014609	9341231011214	4 x 14" / 100 x 355mm	4	12	\$46.36
OX-P014601	9341231011207	4¾ x 14" / 120 x 356mm	4	12	\$49.80
OX-P014691	9341231011238	4½ x 16" / 115 x 405mm	4	12	\$51.93
OX-P014692	9341231011245	4½ x 17¾" / 115 x 450mm	4	12	\$55.06
OX-P014693	9341231011252	4½ x 19½" / 115 x 500mm	4	12	\$60.57
OX-P014665	9341231011221	4½ x 24" / 115 x 600mm	4	12	\$68.01



PRO POOL TROWEL – FLEXIBLE

FEATURES

- Heavy duty aluminium shank
- 'Double hung' DURAGRIP handle
- Stainless steel rivets holds the blade, shank and handle together with unsurpassed strength
- High grade stainless steel blade



Product Code	Barcode	Size	Inner Qty	Outer Qty	List Price
OX-P015712	9341231013744	4 x 11 $\frac{3}{4}$ " / 100 x 300mm	4	12	\$41.64
OX-P015714	9341231013751	4 x 14" / 100 x 356mm	4	12	\$43.08
OX-P015718	9341231013768	4 x 18" / 100 x 457mm	4	12	\$48.43
OX-P015722	9341231013775	4 $\frac{1}{2}$ x 22" / 115 x 558mm	4	12	\$54.95

PRO POOL TROWEL – RIGID

FEATURES

- Heavy duty aluminium shank
- DURAGRIP handle
- Stainless steel rivets holds the blade, shank and handle together with unsurpassed strength
- High grade stainless steel blade



Product Code	Barcode	Size	Inner Qty	Outer Qty	List Price
OX-P015818	9341231013782	4 $\frac{1}{2}$ x 17 $\frac{3}{4}$ " / 110 x 450mm	4	12	\$49.24

PRO SQUARE FINISHING TROWEL

FEATURES

- Heavy duty aluminium shank
- Double hung' DURAGRIP handle
- Stainless steel rivets holds the blade, shank and handle together with unsurpassed strength
- High grade stainless steel blade



Product Code	Barcode	Size	Inner Qty	Outer Qty	List Price
OX-P014702	9341231013799	4 $\frac{3}{4}$ x 11" / 120 x 280mm	4	12	\$49.96
OX-P014773	9341231013805	4 $\frac{3}{4}$ x 14" / 120 x 356mm	4	12	\$54.90
OX-P014781	9341231013812	4 $\frac{1}{2}$ x 16" / 115 x 405mm	4	12	\$49.89



PRO WIDE WALKING EDGER



FEATURES

- High grade stainless steel blade
- Rivetted handle support
- Complete with fixed walking bracket
- Blade size: 5½ x 6¼" / 140 x 160mm

Product Code	Barcode	Radius / Depth	Inner Qty	Outer Qty	List Price
OX-P401310	9341231025051	10mm, 12mm	4	12	\$49.96
OX-P401316	9341231025068	16mm, 18mm	4	12	\$54.90
OX-P401320	9341231025075	20mm, 20mm	4	12	\$49.89

PRO NARROW WALKING GROOVER



FEATURES

- High grade stainless steel blade
- Complete with fixed walking bracket
- Groove: Width 5/8" - 5/16" 15-8mm
- Depth ¾" 19mm

Product Code	Barcode	Blade Size	Inner Qty	Outer Qty	List Price
OX-P401203	9341231013799	3 x 6 ¼" / 75 x 160mm	4	32	\$61.00

PRO WIDE WALKING GROOVER



FEATURES

- High grade stainless steel blade
- Complete with fixed walking bracket
- Groove: Width 5/8" - 5/16" 15-8mm
- Depth 25/32" 20mm

Product Code	Barcode	Blade Size	Inner Qty	Outer Qty	List Price
OX-P401206	9341231025037	6 x 6" / 150 x 160mm	4	24	\$62.20

PRO WALKING ALL SIDES UP FLOAT



FEATURES

- High grade stainless steel blade
- Complete with fixed standing bracket

Product Code	Barcode	Size	Inner Qty	Outer Qty	List Price
OX-P401416	9431231025099	6¼ x 8¼" / 160 x 210mm	1	15	\$47.00
OX-P401438	9431231025006	6 x 15" / 150 x 380mm	1	10	\$55.50



PRO FIXED WALKING TROWEL

FEATURES

- Complete with fixed bracket
- High grade stainless steel

Product Code	Barcode	Size	Inner Qty	Outer Qty	List Price
OX-P402760	9341231034374	4¼ x 24" / 120 x 600mm	2	6	\$83.04
OX-P402790	9341231034381	4¼ x 36" / 120 x 900mm	2	6	\$112.94



PRO FRESNO WALKING TROWEL

FEATURES

- Complete with Fresno Bracket
- High grade stainless steel

Product Code	Barcode	Size	Inner Qty	Outer Qty	List Price
OX-P402860	9341231034398	4¼ x 24" / 120 x 600mm	2	6	\$90.54
OX-P402890	9341231034404	4¼ x 36" / 120 x 900mm	2	6	\$112.00



PRO TILT WALKING TROWEL

FEATURES

- Complete with tilt bracket
- High grade stainless steel

Product Code	Barcode	Size	Inner Qty	Outer Qty	List Price
OX-P402960	9341231034411	4¼ x 24" / 120 x 600mm	2	6	\$128.44
OX-P402990	9341231034428	4¼ x 36" / 120 x 900mm	2	6	\$158.33

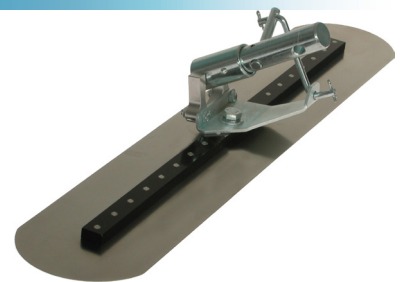

PRO WALKING TROWEL STANDING BRACKET

FEATURES

- Zinc plated steel
- Fully adjustable
- 25mm Ø Fitting

Product Code	Barcode	Inner Qty	Outer Qty	List Price
OX-P016203	9341231021589	N/A	6	\$26.36





PRO WALKING TROWEL MECHANISM

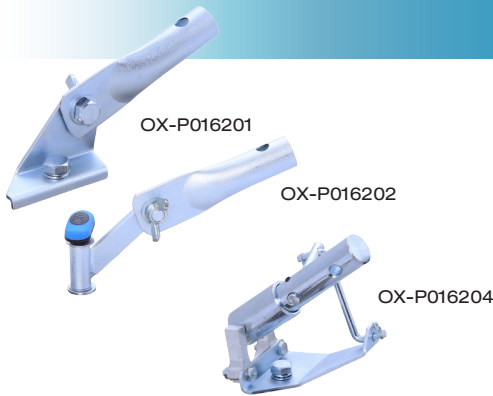

FEATURES

- Zinc plated steel
- Fully adjustable
- 25mm Ø Fitting

Product Code	Barcode	Inner Qty	Outer Qty	List Price
OX-P016201	9341231021596	4	12	\$13.77
OX-P016202	9341231021602	4	12	\$17.01
OX-P016204	9341231021619	4	12	\$59.37

PRO TRADITIONAL FLOOR SQUEEGEE



FEATURES

- Hard rubber blade
- Pre-galvanised steel frame
- Tapered fitting
- Fitting: 27-20mm

Product Code	Barcode	Size	Inner Qty	Outer Qty	List Price
OX-P250691	9341231013911	36" / 910mm	4	12	\$87.67

PRO TRADITIONAL FLOOR SQUEEGEE – CURVED



FEATURES

- Curved ends for greater control of liquids
- Pre-galvanised steel frame with built-in scraper
- Hard rubber blade
- Tapered fitting
- Fitting: 27-20mm

Product Code	Barcode	Blade Size	Inner Qty	Outer Qty	List Price
OX-P250791	9341231013928	36" / 910mm	4	12	\$79.86

PRO 750MM H/D FLOOR SQUEEGEE HEAD



FEATURES HEAD ONLY

- Red neoprene - excellent resistance to salt acids, gasoline, fats, grease, etc.
- Rust resistant galvanised steel frame, etc.
- Splash guard and reinforced handle socket
- Parallel fitting
- Fitting: 25mm

Product Code	Barcode	Blade Size	Inner Qty	Outer Qty	List Price
OX-P250575	9341231013904	29 1/2" x 750mm	1	6	\$71.63

PRO CONCRETE FINISHING BROOM



FEATURES

- Cast aluminium back
- Premium fibre bristles
- Complete with adaptor to suit telescopic handle

Product Code	Barcode	Size	Inner Qty	Outer Qty	List Price
OX-P060390	9341231025174	36" / 900mm	2	6	\$97.54



PRO RUB BRICK

FEATURES

- Fluted silicone carbide
- Contoured one piece plastic handle

Product Code	Barcode	Size	Inner Qty	Outer Qty	List Price
OX-P071008	9341231025181	8 x 3½" / 200 x 90mm	N/A	6	\$40.91



PRO RUB BRICK - ROUND

FEATURES

- Silicone carbide
- Contoured one piece plastic handle

Product Code	Barcode	Size	Inner Qty	Outer Qty	List Price
OX-P071106	9341231025198	6 x 1" / 150 x 20mm	N/A	6	\$36.63



TRADE KNEELING BOARD

FEATURES

- One piece base - with built in extra grip handles
- One piece foam
- Firm foam for greater knee support

Product Code	Barcode	Size	Inner Qty	Outer Qty	List Price
OX-T240300	9341231001284	350 x 480mm	N/A	10	\$29.80



PRO HEAVY DUTY PRY BAR

FEATURES

- Powder coated finish all steel
- Hardened steel claw
- Ideal for prying formwork

Product Code	Barcode	Size	Inner Qty	Outer Qty	List Price
OX-P092856	9341231025846	56" / 1425mm	4	16	\$182.38





PRO INDUSTRIAL CONCRETE SPRAYER - 13.2L



New

FEATURES

- Stainless Steel Heavy Duty Pump
- Stainless Steel Spray Wand
- Stainless Steel Tank
- Flexible Heavy Duty Chemical Resistant Hose
- Superior Lock-on Trigger Assembly
- Ergonomic Pump Handle
- Genuine OXSeals Equipped
- Wide Mouth Opening for Easy Filling & Cleaning
- Holster for Wand & Nozzle Storage

Product Code	Barcode	Size	Inner Qty	Outer Qty	List Price
OX-P040713	9341231014413	13.2L	1	6	\$270.00

Includes Bonus
OXSeal Kit!

Stainless
Steel Tank





PRO CONCRETE SPRAYER REPLACEMENT PARTS LIST



Code	Description	Parts Included	List Price
OX-P049301	OX Brass Fan Nozzle - 1.0 GPM (3.8LPM)	17	\$18.82
OX-P049302	OX 600mm Stainless Steel Spray Wand	14,15 & 16	\$49.33
OX-P049303	OX Trigger Assembly	7, 8, 9, 10, 11,12 & 13	\$70.27
OX-P049304	OX 1200mm Chemical Resistant Hose with Connections	6	\$71.96
OX-P049305	OX Genuine OXSeal and Gasket Kit	4, 5, 9, 13, 14, 16, 21, 22, 23 & 25	\$64.42
OX-P049306	OX Stainless Steel Pump Assembly	20, 21, 22, 23, 24 & 25	\$139.89
OX-P049307	OX Plunger Assembly	20 & 21	\$95.63
OX-P049310	OX Supply Tube Assembly	3, 4 & 5	\$57.22



TRADE REPLACEMENT BLADES – STYLE 1 COMBINATION BLADE SET (4)



FEATURES

- Suitable for 34" machines
- 3/8" BSW threads
- Heat treated - for better wear
- Boxed for easy storage

Product Code	Barcode	No. of Threaded Holes	Size	Inner Qty	Outer Qty	List Price
OX-T181401	9341231000720	2	322x187mm	1	1	\$65.30

Suits: Master Finish 34" / Coates 34" / Cromellins 34" / Flextool 34"

TRADE REPLACEMENT BLADES – STYLE 2 COMBINATION BLADE SET (4)



FEATURES

- Suitable for 40" machines
- 3/8" BSW threads
- Heat treated - for better wear

Product Code	Barcode	No. of Threaded Holes	Size	Inner Qty	Outer Qty	List Price
OX-T181402	9341231000737	3	375x202mm	1	1	\$88.36

Suits: OX-PT40 / Master Finish 40" / Cromellins 40" / Flextool 40"

TRADE REPLACEMENT BLADES – STYLE 3 COMBINATION BLADE SET (4)

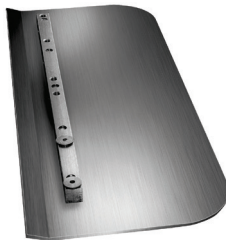

FEATURES

- Suitable for 46" & 48" machines
- 5/16" UNC threads
- Heat treated - for better wear
- 12 x replacement square head bolts included

Product Code	Barcode	No. of Threaded Holes	Size	Inner Qty	Outer Qty	List Price
OX-T181403	9341231000744	6	450x187mm	1	1	\$105.78

Suits: OX-PT46 / Master Finish 48" / Flextool 46" / Wackers 46" / Bartell 46"

TRADE REPLACEMENT BLADES – STYLE 4 COMBINATION BLADE SET (4)



FEATURES

- Suitable for 34" machines
- Heat treated - for better wear
- 16 x replacement square head bolts and locking nuts included

Product Code	Barcode	No. of Threaded Holes	Size	Inner Qty	Outer Qty	List Price
OX-T181404	9341231000751	3	322x187mm	1	1	\$58.42

Suits: Master Finish 34"

TRADE REPLACEMENT BLADES – STYLE 5 COMBINATION BLADE SET (4)



FEATURES

- Suitable for 40" machines
- Heat treated - for better wear
- 16 x replacement square head bolts and locking nuts included

Product Code	Barcode	No. of Threaded Holes	Size	Inner Qty	Outer Qty	List Price
OX-T181405	9341231000768	4	375x200mm	1	1	\$75.03

Suits: Master Finish 40"



TRADE REPLACEMENT BLADES – STYLE 6 COMBINATION BLADE SET (4)

FEATURES

- Suitable for 34" & 36" machines
- 8 x replacement bolts
- 5/16" UNC threads

Product Code	Barcode	No. of Threaded Holes	Size	Inner Qty	Outer Qty	List Price
OX-T181406	9341231000775	3	355x187mm	1	1	\$72.48

Suits: OX-PT34 / Suits: OX-PT36 / Flextool 36" / Wackers 36" / Bartell 36" / Bartell 40"

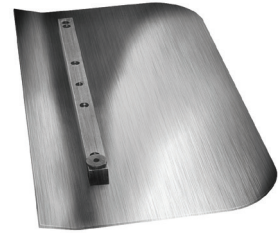

TRADE REPLACEMENT BLADES – STYLE 7 FINISHING BLADE SET (4)

FEATURES

- Suitable for 46" & 48" machines
- Heat treated - for better wear
- 5/16" UNC threads

Product Code	Barcode	No. of Threaded Holes	Size	Inner Qty	Outer Qty	List Price
OX-T181407	9341231000782	6	455x152mm	1	1	\$92.51

Suits: OX-PT46 / Master Finish 48" / Flextool 46" / Wackers 46" / Bartell 46"



TRADE REPLACEMENT BLADES – STYLE 8 FINISHING BLADE SET (4)

FEATURES

- Suitable for 40" machines
- Heat treated - for better wear
- 3/8" BSW threads

Product Code	Barcode	No. of Threaded Holes	Size	Inner Qty	Outer Qty	List Price
OX-T181408	9341231000799	3	375x152mm	1	1	\$73.78

Suits: OX-PT40 / Master Finish 40" / Flextool 40" / Cromellins 40"



TRADE REPLACEMENT BLADES – STYLE 9 FINISHING BLADE SET (4)

FEATURES

- Suitable for 36" machines
- Heat treated - for better wear
- 5/16" UNC threads

Product Code	Barcode	No. of Threaded Holes	Size	Inner Qty	Outer Qty	List Price
OX-T181409	9341231000805	3	375x152mm	1	1	\$65.49

Suits: OX-PT34 / OX-PT36 / Flextool 36" / Wackers 36" / Bartell 36"



TRADE REPLACEMENT BLADES – STYLE 10 FINISHING BLADE SET (4)

FEATURES

- Suitable for 24" edging machines
- Heat treated - for better wear
- M16 threads

Product Code	Barcode	No. of Threaded Holes	Size	Inner Qty	Outer Qty	List Price
OX-T181410	9341231000812	2	230x120mm	1	1	\$46.02

Suits: OX-PT24 / Flextool 24" / Bartell 24"





Bricklaying Tools

With OX Group International being at the forefront of global hand tool developments it's no surprise that professional trades people all over the world are increasingly choosing OX as their 'Tools of Choice'.



These tools are all individually forged from a special high grade carbon steel which is precision taper ground with a class leading heavy duty shank. What's more is the handles are manufactured from a special PVC with a DURAGRIP coating which produces a tool that is not only comfortable to use day in day out for the professional but they last and last.

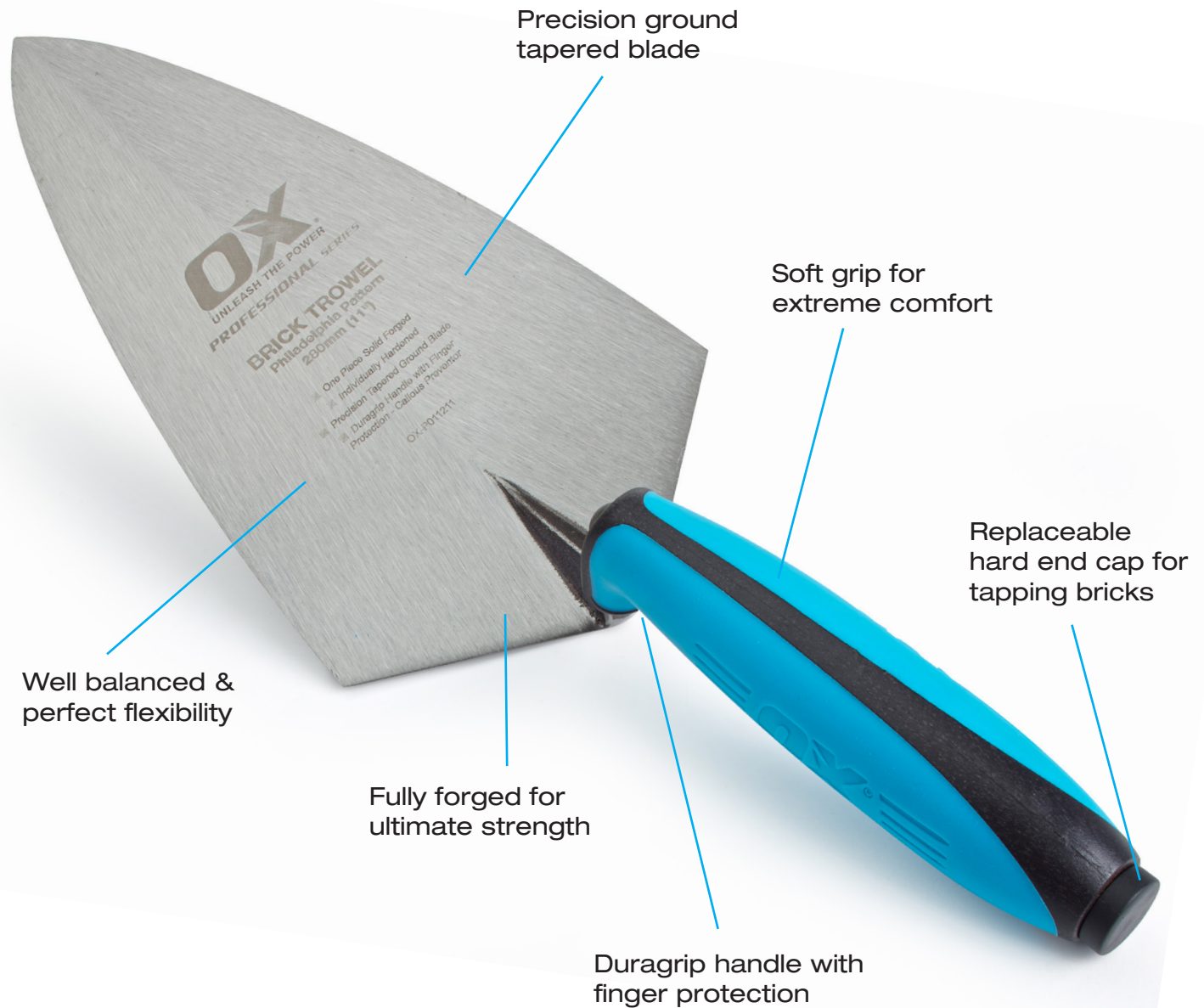



PRO POINTING TROWEL



FEATURES

- DURAGRIP handle
- Welded shank
- Precision taper ground blade

Product Code	Barcode	Size	Inner Qty	Outer Qty	List Price
OX-P013606	5060242330308	2¾" x 6" / 70 x 152mm	4	12	\$16.83

TRADE GAUGING TROWEL



FEATURES

- Quality carbon steel blade
- Welded shank
- High quality timber handle

Product Code	Barcode	Size	Inner Qty	Outer Qty	List Price
OX-T011407	9341231022401	3½ x 7" / 90 x 178mm	4	12	\$9.64

PRO GAUGING TROWEL



FEATURES

- DURAGRIP handle
- Welded shank
- Flexible precision taper ground blade

Product Code	Barcode	Size	Inner Qty	Outer Qty	List Price
OX-P011307	5060242330261	3½ x 7" / 88 x 178mm	4	12	\$19.67
OX-P011308	9341231010804	3½ x 8" / 95 x 203mm	4	12	\$22.23

PRO BRICK TROWEL – LONDON



FEATURES

- Quality carbon steel blade
- DURAGRIP handle
- Welded shank

Product Code	Barcode	Size	Inner Qty	Outer Qty	List Price
OX-P010312	9341231023036	6 x 12" / 150 x 302mm	4	12	\$32.27



PRO FORGED BRICK TROWEL – LONDON

FEATURES

- DURAGRIP handle
- Heavy duty shank
- Precision taper ground blade
- One piece forged hi-carbon steel

Product Code	Barcode	Size	Inner Qty	Outer Qty	List Price
OX-P011111	5060242330643	6 x 11" / 150 x 280mm	4	12	\$76.78
OX-P011112	9341231020445	6 x 12" / 150 x 302mm	4	12	\$65.35



PRO FORGED BRICK TROWEL – PHILADELPHIA

FEATURES

- DURAGRIP handle
- Heavy duty shank
- Precision taper ground blade
- One piece forged hi-carbon steel

Product Code	Barcode	Size	Inner Qty	Outer Qty	List Price
OX-P011212	9341231011917	6 x 12" / 150 x 302mm	4	12	\$65.35



PRO MARGIN TROWEL

FEATURES

- High quality carbon steel
- Flat rectangular blade
- DURAGRIP handle for extreme comfort
- Precision tapered ground blade

Product Code	Barcode	Size	Inner Qty	Outer Qty	List Price
OX-P013416	9341231014321	2" x 6" / 50 x 150mm	4	12	\$19.67
OX-P013418	9341231014338	2" x 8" / 50 x 200mm	4	12	\$22.24



PRO MORTAR SMOOTHING TOOL

FEATURES

- DURAGRIP handle
- Bright steel finish
- One piece spring steel

Product Code	Barcode	Size	Inner Qty	Outer Qty	List Price
OX-P011506	9341231013522	285 x 6mm	4	12	\$16.24
OX-P011508	9341231013249	285 x 8mm	4	12	\$16.24
OX-P011510	5060242330346	285 x 10mm	4	12	\$17.08
OX-P011512	5060242330285	285 x 12mm	4	12	\$17.08





PRO SPOON JOINTER



FEATURES

- High quality carbon steel
- One piece spring steel

Product Code	Barcode	Size	Inner Qty	Outer Qty	List Price
OX-P030813	9341231011368	3/8 & 1/2" / 10 & 13mm	4	12	\$11.47
OX-P030816	9341231011375	1/2 & 5/8" / 13 & 16mm	4	12	\$11.47
OX-P030819	9341231034329	5/8 & 3/4" / 16 & 19mm	4	12	\$11.47
OX-P030822	9341231034336	3/4 & 7/8" / 19 & 22mm	4	12	\$11.47

PRO STEEL BRICK JOINTER



FEATURES

- DURAGRIP handle
- High quality bright steel

Product Code	Barcode	Size	Inner Qty	Outer Qty	List Price
OX-P030310	9341231004803	495 x 10mm	4	12	\$19.67
OX-P030312	9341231004810	495 x 12mm	4	12	\$22.15
OX-P030316	9341231004827	495 x 16mm	4	12	\$28.56

PRO ACRYLIC BRICK JOINTER



FEATURES

- DURAGRIP handle
- One piece moulded acrylic
- Non stain acrylic for rolled joints
- Used for light coloured mortar - doesn't burn

Product Code	Barcode	Size	Inner Qty	Outer Qty	List Price
OX-P030210	9341231022043	495 x 10mm	4	24	\$24.27
OX-P030212	9341231022050	495 x 12mm	4	24	\$24.27

PRO NON STAIN ROLL JOINTER



FEATURES

- Made from hardened acrylic material
- Will not mark or discolour white mortar
- 230mm in length
- Chamfered end

Product Code	Barcode	Size	Inner Qty	Outer Qty	List Price
OX-P031209	9341231037580	25 x 230mm	5	20	\$19.36



PRO BALL JOINTER

FEATURES

- Ball head for consistent joints from any angle
- Small design
- Two sizes in one tool

Product Code	Barcode	Ball Size	Inner Qty	Outer Qty	List Price
OX-P031322	9341231015878	22mm & 19mm	10	50	\$18.00



PRO POLY WHEEL ROLLER RAKER

FEATURES

- DURAGRIP handle
- Adjustable rake depth
- Zinc plated
- Steel frame

Product Code	Barcode	Size	Inner Qty	Outer Qty	List Price
OX-P030501	9341231020285	220 x 93mm	4	12	\$29.12



PRO POLY WHEEL ROLLER RAKER - LONG HANDLE

FEATURES

- DURAGRIP handle
- Adjustable rake depth
- Zinc plated
- Steel frame

Product Code	Barcode	Size	Inner Qty	Outer Qty	List Price
OX-P030602	9341231020721	323 x 93mm	4	12	\$24.62



PRO ALL STEEL ROLLER RAKER

FEATURES

- DURAGRIP handle
- Adjustable rake depth
- Steel wheels
- Steel frame

Product Code	Barcode	Size	Inner Qty	Outer Qty	List Price
OX-P030703	9341231020735	220 x 75mm	4	12	\$28.23



PRO ROLLER RAKER

FEATURES

- DURAGRIP handle
- Adjustable rake depth
- Poly wheels
- Steel frame

Product Code	Barcode	Size	Inner Qty	Outer Qty	List Price
OX-P030115	9341231022067	275 x 120mm	4	12	\$32.76





PRO ROLLER RAKER WHEEL



FEATURES

- DURAGRIP handle
- Adjustable rake depth
- Poly wheels
- Steel frame

Product Code	Barcode	Inner Qty	Outer Qty	List Price
OX-P039801	9341231022074	N/A	12	\$3.41

PRO BRICK JOINT RAKER



FEATURES

- Strong aluminium handle contoured to fit the hand
- Two hard wearing wheels and replaceable point

Product Code	Barcode	Size	Inner Qty	Outer Qty	List Price
OX-P031003	5060242330292	8½ x 3" / 216 x 76mm	4	12	\$34.56

PRO DUTCH PIN

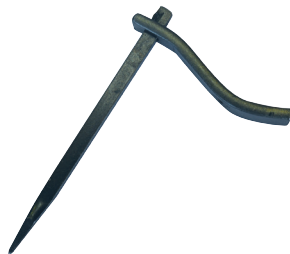

FEATURES

- Square shank
- Solid forged and hardened
- 100 x 150mm

Product Code	Barcode	Pack Qty	Inner Qty	Outer Qty	List Price
OX-P100215	9341231022098	1	6	24	\$9.78
OX-P100215B	9341231022104	100	1	1	\$705.65

PRO DUTCH PIN - SWIVEL



FEATURES

- Semi-round swivel arm
- Solid forged and hardened
- Made from special high quality steel
- Galvanised
- 100 x 150mm

Product Code	Barcode	Pack Qty	Inner Qty	Outer Qty	List Price
OX-P100715	9341231013621	4	4	16	\$50.00
OX-P100715B	9341231034343	100	N/A	1	\$1000.00



PRO DUTCH PIN - FIXED

FEATURES

- Semi-round fixed arm
- Solid forged and hardened
- Made from special high quality steel
- Galvanised
- 100 x 150mm

Product Code	Barcode	Pack Qty	Inner Qty	Outer Qty	List Price
OX-P100615	9341231013014	4	4	16	\$50.00
OX-P100615B	9341231034350	100	N/A	1	\$1000.00



TRADE STRING LINE - 8 GAUGE

FEATURES

- Tough synthetic high tensile strength (42.8kg / 855 Tex)
- Ideal for layout work, brick and block laying
- Flexible plastic spool

Product Code	Barcode	Size	Inner Qty	Outer Qty	List Price
OX-T102805	9341231013102	Fluro Lime / 50m	12	48	\$6.89
OX-T102810	9341231013119	Fluro Lime / 100m	12	48	\$10.67
OX-T102905	9341231013126	Fluro Pink / 50m	12	48	\$6.89
OX-T102910	9341231013133	Fluro Pink / 100m	12	48	\$10.67
OX-T103005	9341231013140	White / 50m	12	48	\$6.42
OX-T103010	9341231013157	White / 100m	12	48	\$8.31



TRADE STRING LINE - 12 GAUGE

FEATURES

- Tough synthetic high tensile strength (66.5kg / 1345 Tex)
- Ideal for layout work, brick and block laying
- Flexible plastic spool

Product Code	Barcode	Size	Inner Qty	Outer Qty	List Price
OX-T103105	9341231013164	White / 50m	12	48	\$7.94
OX-T103110	9341231013171	White / 100m	12	48	\$14.54
OX-T103205	9341231013287	Fluro Lime / 50m	12	48	\$7.94
OX-T103210	9341231013294	Fluro Lime / 100m	12	48	\$14.28





PRO RUBBER LINE BLOCK – SINGLE

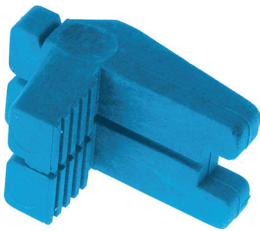

FEATURES

- One piece rubber
- DURAGRIP

Product Code	Barcode	Size	Inner Qty	Outer Qty	List Price
OX-P101801	9341231020261	61 x 41 x 35mm	12	96	\$4.96

PRO RUBBERISED LARGE LINE BLOCK – PAIR

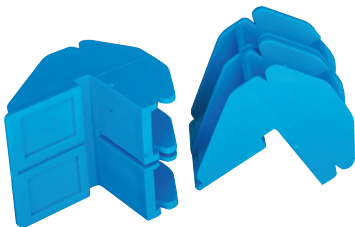

FEATURES

- One piece
- Rubberised DURAGRIP

Product Code	Barcode	Size	Inner Qty	Outer Qty	List Price
OX-P101502	9341231001239	75 x 65 x 57mm	N/A	18	\$10.96

TRADE PLASTIC LINE BLOCK – PAIR

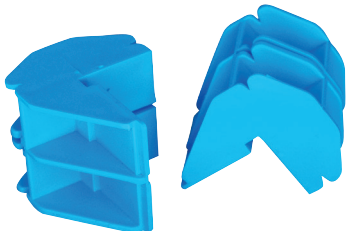

FEATURES

- High impact plastic
- High visibility blue colour

Product Code	Barcode	Size	Inner Qty	Outer Qty	List Price
OX-T101601	9341231011351	75 x 65 x 57mm	N/A	18	\$8.14

PRO LINE PIN



FEATURES

- One piece drop forged
- Large head
- Chrome plated
- 150 x 25mm

Product Code	Barcode	Pack Qty	Inner Qty	Outer Qty	List Price
OX-P100101	9341231012935	1	6	24	\$9.45
OX-P100101B	9341231024221	100	N/A	1	\$785.88



PRO PROFILE CLAMP

FEATURES

- Solid steel & zinc plated
- 'T' bolt thumb screw
- Thread length 80mm

Product Code	Barcode	Size	Inner Qty	Outer Qty	List Price
OX-P100302	9341231013829	50mm	4	12	\$15.05
OX-P100307	9341231020216	178mm	4	12	\$19.69
OX-P100312	9341231020223	300mm	4	12	\$20.35



PRO INTERNAL PROFILE CLAMP

FEATURES

- Solid steel & zinc plated
- DURAGRIP 'T' bolt thumb screw
- Thread length 80mm

Product Code	Barcode	Size	Inner Qty	Outer Qty	List Price
OX-P102007	9341231022159	178mm	4	12	\$13.90
OX-P102012	9341231022166	300mm	4	12	\$18.54

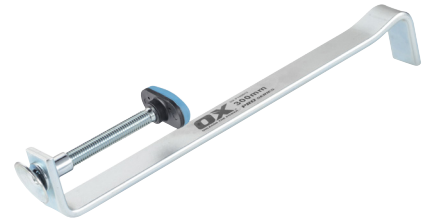

PRO MORTAR SPIKE

FEATURES

- Solid steel & zinc plated
- New 'thread insert' threading system
- DURAGRIP 'T' bolt/thumb screw
- Thread length 80mm

Product Code	Barcode	Size	Inner Qty	Outer Qty	List Price
OX-P102201	5060242330308	120 x 30mm	4	12	\$23.39



PRO 'T' PROFILE CLAMP

FEATURES

- Zinc plated solid steel
- DURAGRIP 'T' bolt/thumb screw
- Thread length 80mm

Product Code	Barcode	Size	Inner Qty	Outer Qty	List Price
OX-P101716	9341231022180	150mm	4	12	\$25.86





PRO INTERNAL PROFILE CLAMP



FEATURES

- Zinc plated solid steel
- New 'thread insert' threading system
- DURAGRIP 'T' bolt/thumb screw
- Throw 0-250mm / Clamp Size 13mm

Product Code	Barcode	Eye Size	Inner Qty	Outer Qty	List Price
OX-P101140	9341231022197	40 x 40mm	4	12	\$43.27

PRO SLIDING PROFILE CLAMP



FEATURES

- Zinc plated solid steel
- DURAGRIP 'T' bolt/thumb screw
- Thread length 80mm

Product Code	Barcode	Size	Inner Qty	Outer Qty	List Price
OX-P101213	9341231021527	330mm	4	12	\$23.82
OX-P101222	9341231021534	560mm	4	12	\$25.52

PRO REPLACEMENT SLIDING PROFILE CLAMP



FEATURES

Arm Only (Single)

- Genuine replacement part
- Zinc plated solid steel
- DURAGRIP 'T' bolt/thumb screw

Product Code	Barcode	Suits	Inner Qty	Outer Qty	List Price
OX-P109901	9341231022203	OX-P101213 & OX-P101222	4	12	\$10.55

PRO NAIL ON PROFILE CLAMP



FEATURES

- New 'thread' insert threading system
- Zinc plated solid steel
- DURAGRIP 'T' bolt/thumb screw
- Thread length 80mm

Product Code	Barcode	Size	Inner Qty	Outer Qty	List Price
OX-P102114	9341231022210	350mm	4	12	\$26.59



PRO DOOR GAUGE

FEATURES

- Zinc plated solid steel
- DURAGRIP 'T' bolt/thumb screw
- 'Eastern States' Style Door Frames

Product Code	Barcode	Clamping Size	Inner Qty	Outer Qty	List Price
OX-P100801	9341231022234	70 x 20mm	4	12	\$31.35



PRO DORI BLOCK WITH LOCK BOLT

FEATURES

- Genuine replacement part
- Zinc plated solid steel
- DURAGRIP 'T' bolt/thumb screw. Can be clamped to the profile pole from either side
- Use with 40 & 50mm profile poles

Product Code	Barcode	Internal Size	Inner Qty	Outer Qty	List Price
OX-P100950	5060242330308	50 x 50mm	4	12	\$47.06

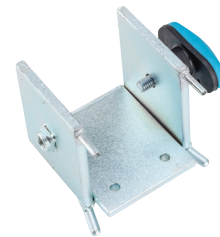

PRO TOP STEADY NAIL-ON (VENEER) CLAMP

FEATURES

Bar & Clamp Set

- Zinc plated solid steel
- DURAGRIP 'T' bolt/thumb screw
- New improved clamping system

Product Code	Barcode	Descriptions	Inner Qty	Outer Qty	List Price
OX-P101002	9341231021503	4 Piece Bar & Clamp Set	4	12	\$32.33



PRO TOP STEADY NAIL-ON (FULL BRICK) CLAMP

FEATURES

Bar & Clamp Set

- Zinc plated solid steel
- DURAGRIP 'T' bolt/thumb screw
- New improved clamping system

Product Code	Barcode	Descriptions	Inner Qty	Outer Qty	List Price
OX-P101001	9341231022258	4 Piece Bar & Clamp Set	4	12	\$47.83





PRO TOP STEADY BAR



FEATURES

- Zinc plated
- Suits OX-P101001 or OX-P101002

Product Code	Barcode	Size	Inner Qty	Outer Qty	List Price
OX-P101080	9341231021510	300 x 800mm	4	12	\$30.67

PRO BRICKLAYERS CLAMP

New



FEATURES

- Ideal for clamping profiles through double brick perps/coarsing

Product Code	Barcode	Size	Inner Qty	Outer Qty	List Price
OX-P200312	9341231015533	50 x 300mm	1	40	\$15.00

PRO PROFILE JACK



FEATURES

- Holds profile pole between floor and flat roof (usually used in high rise building situation)
- Zinc plated solid steel
- Suits 40mm square poles

Product Code	Barcode	Size	Inner Qty	Outer Qty	List Price
OX-P102310	9341231022265	40mm	2	8	\$42.74

PRO HEAVY DUTY PROFILE POLE



FEATURES

- Durable galvanised steel
- Fine precise lines
- Reversible, two-sided markings
- Professionally marked with the latest technology automatic machine
- Profile size 40 x 40mm
- Number of coarses 33

Product Code	Barcode	Length	Inner Qty	Outer Qty	List Price
OX-P102432	9341231034060	2.83m	12	48	\$84.59



PRO PROFILE PROP

FEATURES

- Professional quality
- Steel heavy duty wing bolt
- High adjustable telescopic arm
- Galvanised steel construction
- Suits OX-P102432 (2 props per profile pole often used)

Product Code	Barcode	Size	Inner Qty	Outer Qty	List Price
OX-P100501	9341231022289	-	1	2	\$103.30

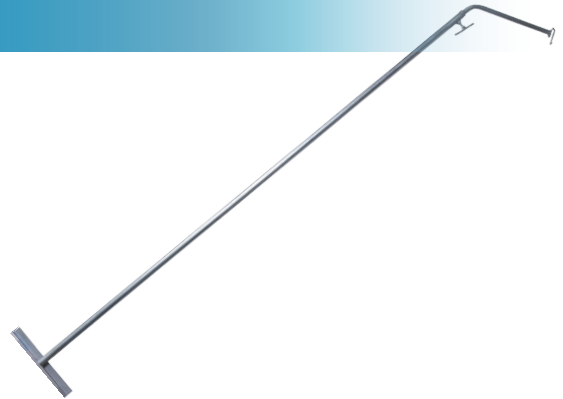

PRO BRICK CARRIER

FEATURES

- DURAGRIP handle
- Adjustable
- Heavy duty construction
- Holds 8 - 12 bricks
- Lift Capacity 45kg

Product Code	Barcode	Jaw Capacity	Inner Qty	Outer Qty	List Price
OX-P170350	9341231020254	400 - 500mm	4	12	\$38.00



PRO LIMESTONE BLOCK CARRIER

FEATURES

- Ergonomic Rubber Hand Grip
- Adjustable Spacings to Suit Different Block Sizes
- Lugs for Extra Grip

Product Code	Barcode	Jaw Capacity	Inner Qty	Outer Qty	List Price
OX-P170701	9341231014635	500mm	4	8	\$46.27





PRO BRICK SPLITTER



FEATURES

- Convenient carry handle
- Single motion breaking action
- Auto levelling blade
- Single point fine adjustment
- Quick change, coarse adjustment pin
- Adjustable integral length stop gauge
- Three sided hard wearing replaceable blades
- Spring loaded support arms

Product Code	Barcode	Inner Qty	Outer Qty	List Price
OX-P190212	9341231022296	1	1	\$847.00

PRO BRICK SPLITTER - REPLACEMENT BLADES

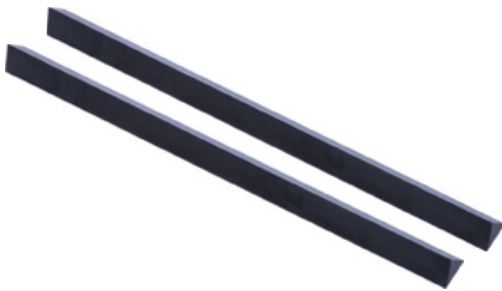

FEATURES

- 2 pack
- 3 Cutting edges on each blade, just slide it out and turn it over
- Easy to change

Product Code	Barcode	Inner Qty	Outer Qty	List Price
OX-P199903	9341231022302	N/A	6	\$140.38

TRADE SCRUB BRUSH – TIMBER STOCK



FEATURES

- Quality smooth timber block
- Yellow crimped poly bristles

Product Code	Barcode	Bristle Area	Inner Qty	Outer Qty	List Price
OX-T061001	9341231022449	65 x 190mm	6	24	\$9.80

TRADE BANNISTER BRUSH - COCO FIBRE



FEATURES

- Quality smooth timber block
- Black dyed coco fibre bristles

Product Code	Barcode	Bristle Area	Inner Qty	Outer Qty	List Price
OX-T060401	9341231011894	35 x 135mm	6	24	\$6.74



TRADE BRICKIES BRUSH – DYED COCO FIBRE

FEATURES

- Quality smooth timber block
- Black dyed coco fibre bristles

Product Code	Barcode	Bristle Area	Inner Qty	Outer Qty	List Price
OX-T060701	9341231022463	70 x 300mm	6	24	\$13.06



TRADE BRICKIES BRUSH – POLY FIBRE

FEATURES

- Quality smooth timber block
- Black poly fibre bristles

Product Code	Barcode	Bristle Area	Inner Qty	Outer Qty	List Price
OX-T060601	9341231022456	70 x 300mm	6	24	\$17.34



PRO ACID BRUSH

FEATURES

- Heavily filled tampico fibre
- Bristles set securely into hardwood block

Product Code	Barcode	Bristle Area	Inner Qty	Outer Qty	List Price
OX-P060207	9341231023323	72 x 210mm	4	12	\$17.11

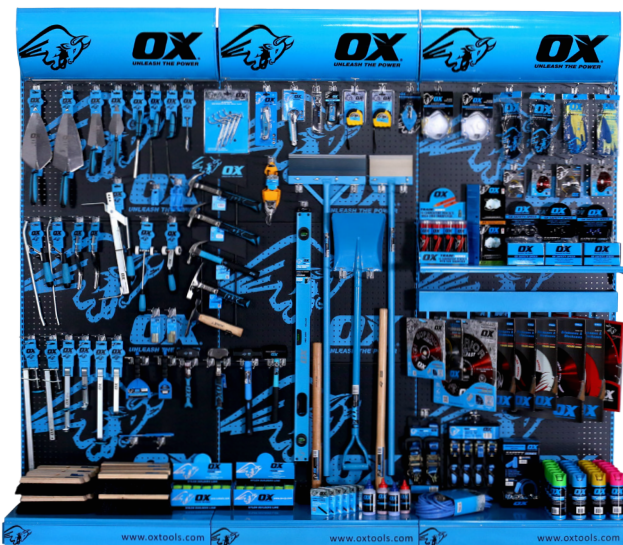

Displays ranges and posters available. See page 205 & 223.





Plastering Tools



No trade is as demanding on the design of its tools as the plastering trade. Many tools look the same, but the OX Range has been tried and tested by tradesmen and offers unmatched quality.

OX tools do what you want them to do, over and over again.

A tough, durable design for the professional plasterer – you'll probably wear out before they do!

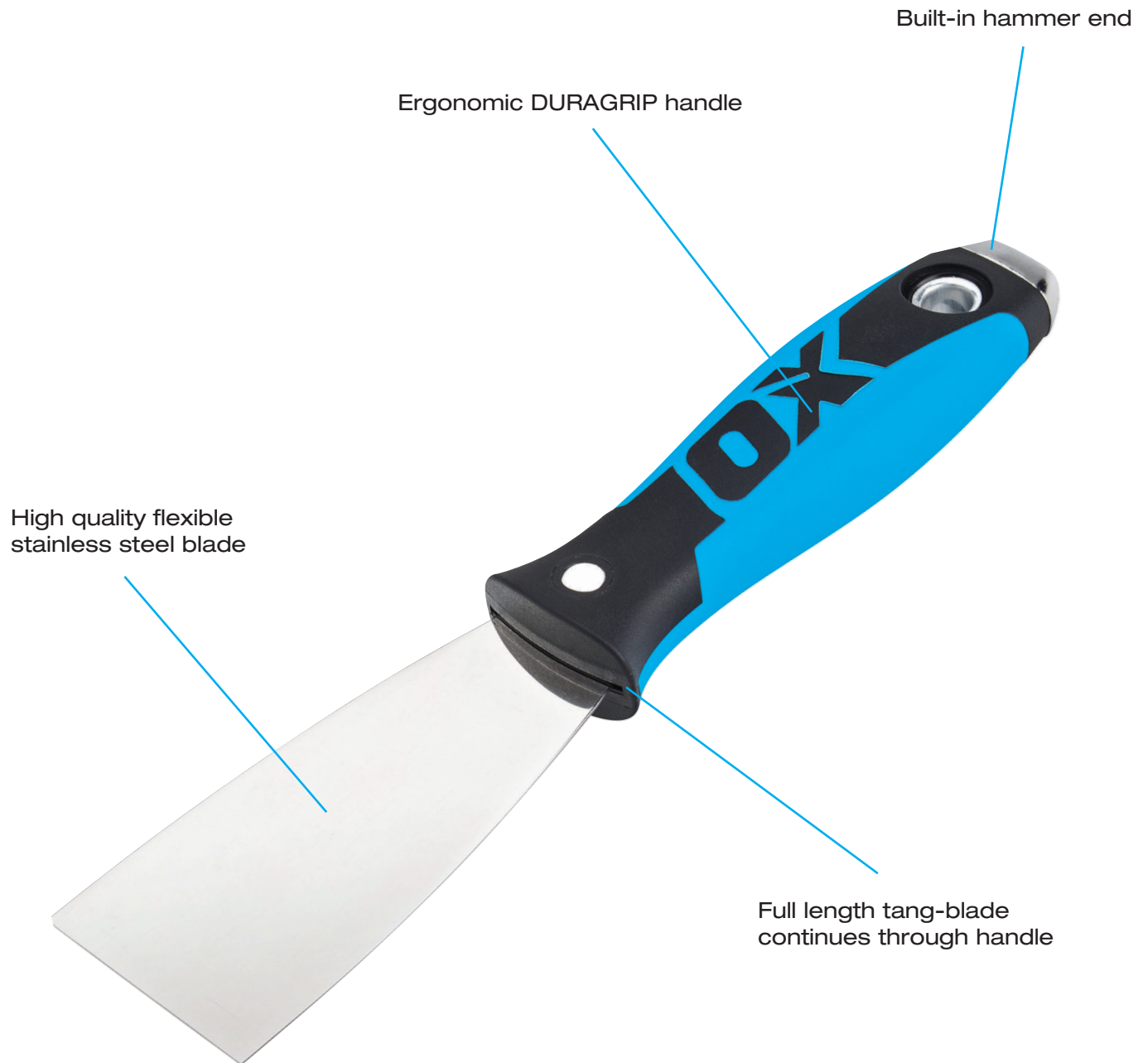



Plastering Tools

PRO SCORE & SNAP KNIFE



FEATURES

- All steel
- Chrome plated
- Bullet point
- Double sided tungsten tipped

Product Code	Barcode	Length	Inner Qty	Outer Qty	List Price
OX-P220102	9341231011764	220mm	4	12	\$22.15

PRO SMALL TOOL



FEATURES

- One piece solid drop forged from high quality carbon steel
- Precision taper ground and tempered

Product Code	Barcode	Width	Inner Qty	Outer Qty	List Price
OX-P010113	5060242330452	13mm	4	12	\$15.80
OX-P010116	5060242330469	16mm	4	12	\$15.80
OX-P010119	5060242330476	19mm	4	12	\$15.80
OX-P010125	5060242330483	25mm	4	12	\$15.80

PRO JOINT KNIFE



FEATURES

- Full length tang-blade continues through handle to a built-in hammer end
- Ergonomic DURAGRIP handle
- High quality flexible stainless steel blade

Product Code	Barcode	Square End Width	Inner Qty	Outer Qty	List Price
OX-P013203	5060242330438	32mm	4	12	\$12.89
OX-P013205	5060242330421	50mm	4	12	\$14.10
OX-P013207	5060242330414	76mm	4	12	\$16.09
OX-P013210	5060242330407	102mm	4	12	\$19.16
OX-P013212	5060242330391	127mm	4	12	\$21.51
OX-P013215	5060242330384	152mm	4	12	\$23.36

PRO TAPING KNIFE



FEATURES

- Strong aluminium back
- Ergonomic DURAGRIP handle
- High quality flexible stainless steel blade

Product Code	Barcode	Square End Width	Inner Qty	Outer Qty	List Price
OX-P013320	9341231001192	200mm	4	12	\$19.42
OX-P013325	9341231010781	250mm	4	12	\$21.51
OX-P013330	9341231010798	300mm	4	12	\$23.73



PRO SMALL INTERNAL CORNER TROWEL

FEATURES

- Sharp 90° Blade
- Ideal for finishing hard-wall plaster

Product Code	Barcode	Size	Inner Qty	Outer Qty	List Price
OX-P408205	9341231015502	50 x 70mm	6	48	\$48.50

New



PRO INTERNAL CORNER TROWEL

FEATURES

- DURAGRIP handle
- Sturdy aluminium shank with strong mounting
- High quality stainless steel blade - will flex to form perfect 90° corners

Product Code	Barcode	Size	Inner Qty	Outer Qty	List Price
OX-P013001	5060242330490	102 x 127mm	4	12	\$31.26



PRO EXTERNAL CORNER TROWEL - SMALL

FEATURES

- Stainless steel blade
- Ergonomic handle
- Blade angle 90° / blade radius 5r

Product Code	Barcode	Blade Size	Inner Qty	Outer Qty	List Price
OX-P015305	9341231021251	26 x 65mm	4	12	\$43.07



PRO EXTERNAL CORNER TROWEL - MEDIUM

FEATURES

- Stainless steel blade
- Ergonomic handle
- Blade angle 90° / blade radius 8r

Product Code	Barcode	Blade Size	Inner Qty	Outer Qty	List Price
OX-P015408	9341231021268	40 x 65mm	4	12	\$45.42





PRO EXTERNAL CORNER TROWEL - LARGE



FEATURES

- Stainless steel blade
- Ergonomic handle
- Blade angle 90° / blade radius 5r (OX-P015505)
- Blade angle 90° / blade radius 8r (OX-P015508)

Product Code	Barcode	Size	Inner Qty	Outer Qty	List Price
OX-P015505	9341231021275	55 x 65mm	4	12	\$47.42
OX-P015508	9341231021282	55 x 65mm	4	12	\$47.42

PRO CORNER TROWEL



FEATURES

- Stainless steel blade
- Ergonomic handle
- Blade angle 90° / blade radius 4r (OX-P015204)
- Blade angle 90° / blade radius 6r (OX-P015206)

Product Code	Barcode	Size	Inner Qty	Outer Qty	List Price
OX-P015204	9341231021220	33 x 180mm	4	12	\$27.28
OX-P015206	9341231021237	45 x 180mm	4	12	\$30.38

PRO CORNER EDGER



FEATURES

- Stainless steel blade
- Blade angle 90° / blade radius 5r

Product Code	Barcode	Size	Inner Qty	Outer Qty	List Price
OX-P015605	9341231022609	25 x 140mm	4	12	\$39.38

PRO WOODEN MITRE BOX



FEATURES

- Laminated plywood
- Durable construction
- Professional quality
- Angle size: 45°

Product Code	Barcode	Internal Size	Inner Qty	Outer Qty	List Price
OX-P023201	9341231013027	90 x 295mm	4	12	\$37.95



PRO PLASTERER'S SQUARE

FEATURES

- Stainless Steel
- Fully adjustable for precise levels



Product Code	Barcode	Internal Size	Inner Qty	Outer Qty	List Price
OX-P020201	9341231022616	210 x 210 x 300mm	6	36	\$25.36

TRADE TIMBER HAND SANDER

FEATURES

- Timber base
- One piece ergonomic plastic handle



Product Code	Barcode	Size	Inner Qty	Outer Qty	List Price
OX-T070601	9341231022760	108 x 280mm	4	12	\$28.73

Ranges available. See page 206.





Rendering Tools



UNLEASH THE POWER
OX
PRO SERIES
Stainless Steel
OX-P011011
114 X 280mm

OX is the most trusted authority on rendering tools in the Australian market. Our reputation for excellence has been forged from dependable service to trades people working in demanding conditions.

The high calibre of OX rendering tools are instinctively recognised on the job site as tough, dynamic and dependable.



Clear product information engraved onto surface

Handle set for perfect balance



Lightweight fully rivetted aluminium shank

DURAGRIP handle for extra comfort

High quality stainless or carbon steel blade

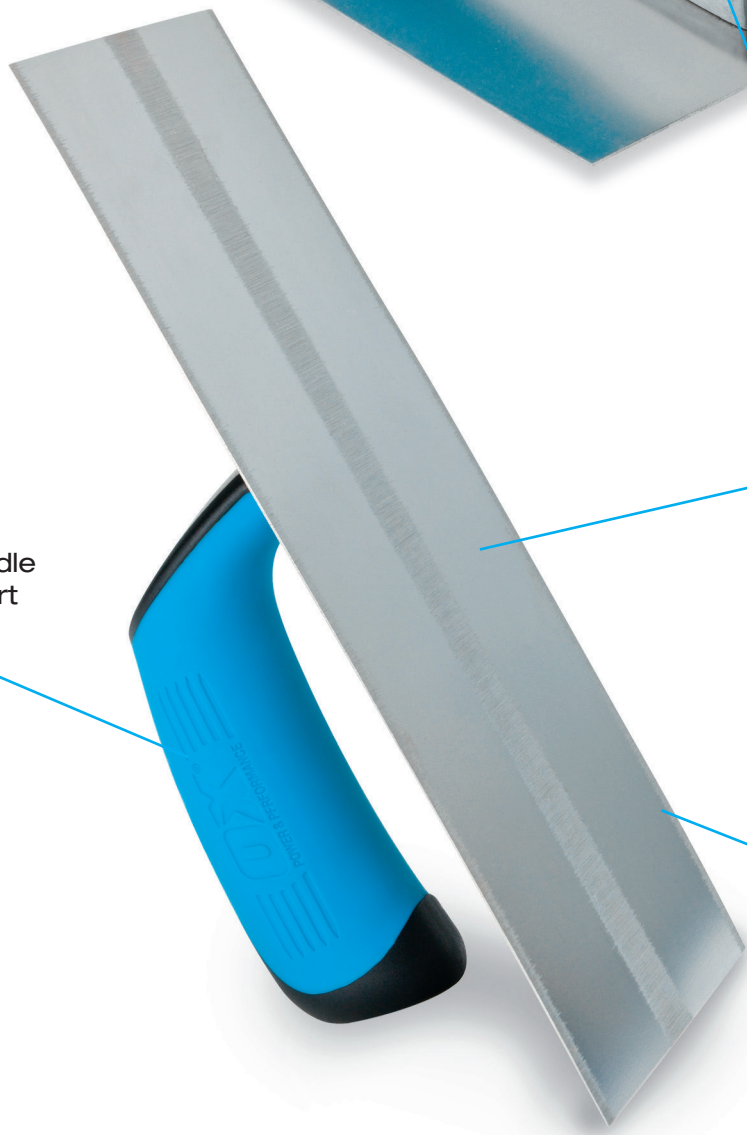

Pre-worn edges to eliminate line & ripple marks



PRO PLASTER SCOOP



FEATURES

- DURAGRIP handle
- Heavy duty galvanised pan - for longevity
- Bracket hang hook - for putting on the side of a bucket

Product Code	Barcode	Size	Inner Qty	Outer Qty	List Price
OX-P010718	9341231011368	180mm	4	12	\$26.53

TRADE ALUMINIUM HAWK

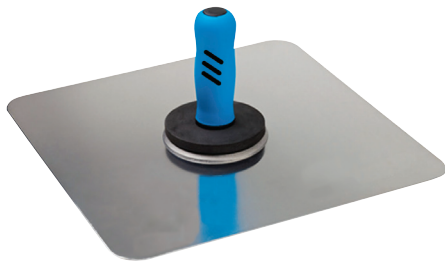

FEATURES

- DURAGRIP handle
- High quality, lightweight and tempered aluminium blade mounted with 6 rivets for extra strength

Product Code	Barcode	Size	Inner Qty	Outer Qty	List Price
OX-T010513	9341231038242	330 x 330mm	4	12	\$36.27

PRO ALUMINIUM HAWK



FEATURES

- DURAGRIP handle
- High quality, lightweight and tempered aluminium blade mounted with 8 rivets for extra strength
- Surface of blade machined to prevent mortar from sliding off and aluminium from bowing or beading

Product Code	Barcode	Size	Inner Qty	Outer Qty	List Price
OX-P010512	9341231010811	300 x 300mm	4	12	\$47.15
OX-P010513	5060242330377	330 x 330mm	4	12	\$49.45

TRADE POLYURETHANE FLOAT



FEATURES

- One piece moulded
- Lightweight

Product Code	Barcode	Size	Inner Qty	Outer Qty	List Price
OX-T010212	9341231011917	120 x 240mm	1	12	\$8.89
OX-T010214	9341231011924	140 x 280mm	1	12	\$10.75
OX-T010218	9341231011931	180 x 320mm	1	12	\$13.70
OX-T010220	9341231011948	200 x 360mm	1	12	\$14.92



PRO RECTANGULAR POLYURETHANE FLOAT

FEATURES

- High quality polyurethane
- One piece moulded
- Made in the EU

Product Code	Barcode	Size	Inner Qty	Outer Qty	List Price
OX-P010212	9341231001819	120 x 240mm	4	12	\$17.07
OX-P010214	9341231001826	140 x 280mm	4	12	\$17.26
OX-P010218	9341231001833	180 x 320mm	4	12	\$20.96
OX-P010220	9341231001840	200 x 360mm	4	12	\$23.10
OX-P010222	9341231001857	220 x 420mm	4	12	\$41.79



PRO ANGULAR POLYURETHANE FLOAT

FEATURES

- High quality polyurethane
- One piece moulded
- Made in the EU

Product Code	Barcode	Size	Inner Qty	Outer Qty	List Price
OX-P010208	9341231001802	80 x 260mm	4	12	\$15.62



PRO RECTANGULAR PLASTIC FLOAT

FEATURES

- High strength ABS plastic
- Diamond patterned base

Product Code	Barcode	Size	Inner Qty	Outer Qty	List Price
OX-P012127	9341231001296	180 x 270mm	4	12	\$15.97
OX-P012144	9341231022467	140 x 440mm	4	12	\$16.26
OX-P012135	9341231010767	270 x 350mm	4	12	\$21.24
OX-P012142	9341231022654	260 x 420mm	4	12	\$22.35



PRO POINTED PLASTIC FLOAT

FEATURES

- High strength ABS plastic
- Diamond patterned base

Product Code	Barcode	Size	Inner Qty	Outer Qty	List Price
OX-P012027	9341231022630	140 x 270mm	4	12	\$15.97





TRADE RED TEXTURE FINISHING TROWEL



FEATURES

- Red ABS blade
- Ergonomic handle

Product Code	Barcode	Size	Inner Qty	Outer Qty	List Price
OX-T010611	9341231016264	130 x 280mm	4	12	\$19.98

PRO RED TEXTURE FINISHING TROWEL



FEATURES

- Red PVC blade
- Ergonomic Duragrip handle

Product Code	Barcode	Size	Inner Qty	Outer Qty	List Price
OX-P408511	9341231015847	130 x 280mm	10	40	\$28.50

PRO CLEAR TEXTURE FINISHING TROWEL



FEATURES

- Clear non-marking blade
- Ergonomic handle

Product Code	Barcode	Size	Inner Qty	Outer Qty	List Price
OX-P011611	9341231001741	130 x 280mm	4	12	\$19.98

TRADE FINISHING TROWEL – TIMBER HANDLE



FEATURES

- Carbon steel blade
- Aluminium shank
- Ergonomic timber handle

Product Code	Barcode	Size	Inner Qty	Outer Qty	List Price
OX-T017211	9341231022784	115 x 280mm	4	12	\$18.32
OX-T017214	9341231022791	120 x 356mm	4	12	\$22.99



TRADE FINISHING TROWEL – RUBBER HANDLE

FEATURES

- Carbon steel blade
- Aluminium shank
- Ergonomic rubber grip handle

Product Code	Barcode	Size	Inner Qty	Outer Qty	List Price
OX-T010911	9341231022807	115 x 280mm	4	12	\$20.46
OX-T010914	9341231022814	120 x 356mm	4	12	\$28.50



PRO FINISHING TROWEL

FEATURES

- High quality tempered steel blade
- Lightweight aluminium shank
- Handle position set for perfect balance
- Extended DURAGRIP handle designed for increased comfort
- More rivets than any other trowel made
- Cross ground blade - for reduced drag and quicker break-in time



CARBON STEEL

Product Code	Barcode	Size	Inner Qty	Outer Qty	List Price
OX-P010908	9341231022524	75 x 200mm	4	12	\$37.18
OX-P010995	9341231022531	100 x 240mm	4	12	\$34.93
OX-P010911	5060242330575	120 x 280mm	4	12	\$39.30
OX-P010914	5060242330582	120 x 356mm	4	12	\$53.32
OX-P010916	5060242330548	100 x 406mm	4	12	\$52.82
OX-P010918	5060242330599	115 x 457mm	4	12	\$73.99

STAINLESS STEEL

Product Code	Barcode	Size	Inner Qty	Outer Qty	List Price
OX-P011008	9341231022555	75 x 200mm	4	12	\$38.61
OX-P011095	9341231022562	100 x 240mm	4	12	\$44.65
OX-P011011	5060242330322	120 x 280mm	4	12	\$49.88
OX-P011014	5060242330339	120 x 356mm	4	12	\$60.08
OX-P011016	9341231022579	100 x 406mm	4	12	\$71.90
OX-P011018	5060242330568	115 x 457mm	4	12	\$78.31

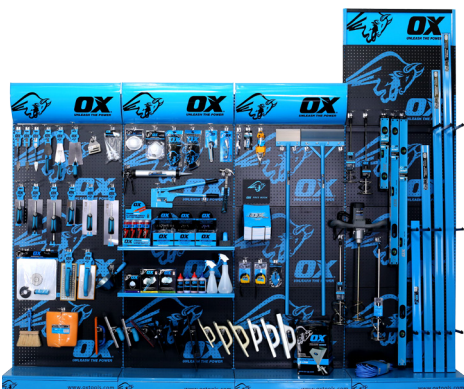

Ranges and Posters available.
See page 206 & 223.





PRO RECTANGULAR POLYSTYRENE FLOAT



FEATURES

- High quality polystyrene
- One piece moulded

Product Code	Barcode	Size	Inner Qty	Outer Qty	List Price
OX-P012814	9341231020308	140 x 260mm	4	12	\$26.02
OX-P012818	9341231020315	180 x 320mm	4	12	\$30.14

PRO BOAT SHAPED POLYSTYRENE FLOAT



FEATURES

- High quality polystyrene
- One piece moulded

Product Code	Barcode	Size	Inner Qty	Outer Qty	List Price
OX-P012718	9341231020292	205 x 350mm	4	12	\$32.30

PRO PERFORATED SPONGE FLOAT



FEATURES

- Zinc plated perforated blade - easy to clean
- Special "fine cell" sponge
- DURAGRIP handle

Product Code	Barcode	Size	Inner Qty	Outer Qty	List Price
OX-P010830	9341231020339	130 x 300mm	4	12	\$31.90

- Replacement sponge
- Special sponge compound - designed for render
- 6 sponges per pack

Product Code	Barcode	Size	Inner Qty	Outer Qty	List Price
OX-P019813	9341231022708	130 x 300mm	6	24	\$23.18

PRO PS RUBBER SPONGE FLOAT



FEATURES

- One piece moulded handle + blade
- Soft - Long life "sponge-rubber" material
- Made in the EU

Product Code	Barcode	Size	Inner Qty	Outer Qty	List Price
OX-P014012	9341231010309	120 x 240mm	4	12	\$43.88
OX-P014014	9341231010316	140 x 280mm	4	12	\$48.52

- Replacement sponge
- Pre-glued for convenience

Product Code	Barcode	Size	Inner Qty	Outer Qty	List Price
OX-P019912	9341231001871	120 x 240mm	6	24	\$21.21
OX-P019914	9341231001888	140 x 280mm	6	24	\$18.24



PRO YELLOW SPONGE FLOAT

FEATURES

- Ideal for sandy surfaces
- Fine cell foam pad specially bonded to an aluminium backing plate
- 1" thick foam sponge
- DURAGRIP handle

Product Code	Barcode	Size	Inner Qty	Outer Qty	List Price
OX-P402414	9341231032622	140 x 280mm	4	12	\$30.45

- Replacement sponge
- 6 sponges per pack

Product Code	Barcode	Size	Inner Qty	Outer Qty	List Price
OX-P402514	9341231032639	140 x 280mm	N/A	6	\$64.90

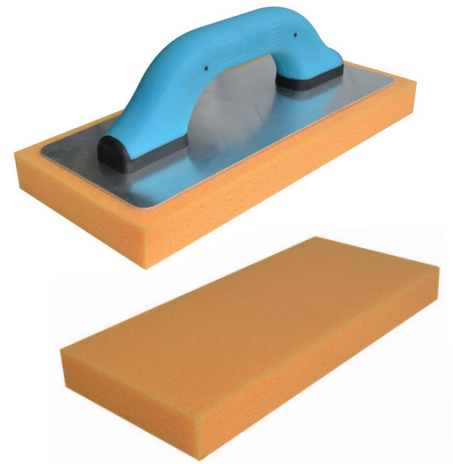

TRADE WEEPHOLE CLEANER

FEATURES

- Stainless steel
- Bottle opener hole – for convenience
- Template for accurate weephole

Product Code	Barcode	Cut-out Size	Inner Qty	Outer Qty	List Price
OX-T030401	9341231001277	75 & 50mm	N/A	6	\$26.10



PRO MASONRY WATER BRUSH

FEATURES

- White tampico fibre bristles
- Bristles set securely into hardwood block
- Handle pinned and glued for secure attachment
- Made in the U.S.A

Product Code	Barcode	Bristles	Inner Qty	Outer Qty	List Price
OX-P060104	9341231013058	4 rows	4	12	\$24.40
OX-P060105	9341231022586	5 rows	4	12	\$29.04



TRADE WATER BRUSH

FEATURES

- Quality smooth timber block
- White coco fibre bristles
- Two knot

Product Code	Barcode	Bristle Area	Inner Qty	Outer Qty	List Price
OX-T060802	9341231011900	120 x 60 x 150mm	6	24	\$26.29





TRADE ACID BRUSH



FEATURES

- Quality smooth timber block
- White coco fibre bristles

Product Code	Barcode	Bristle Area	Inner Qty	Outer Qty	List Price
OX-T060801	9341231022821	50mm	6	24	\$7.81

TRADE TEXTURE GUN – SQUARE



FEATURES

- Ideal for applying masonry coatings - cement render, and concrete re-surfacing products
- With airflow regulator and 45° elbow
- Operating pressure bar 3.0-4.0
- Air volume usage 0.623 CBM / min

Product Code	Barcode	Hopper Capacity	Inner Qty	Outer Qty	List Price
OX-T040308	9341231013607	8L	N/A	6	\$129.82

TRADE REPLACEMENT TEXTURE GUN NOZZLES

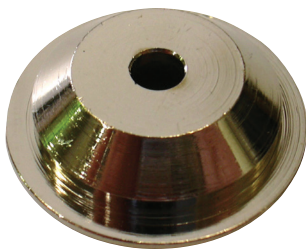

FEATURES

- Genuine OX parts

Product Code	Barcode	Size	Inner Qty	Outer Qty	List Price
OX-P049703	9341231021886	4mm	N/A	6	\$3.43
OX-P049704	9341231021893	6mm	N/A	6	\$3.43
OX-P049705	9341231021909	8mm	N/A	6	\$3.43

TRADE TEXTURE GUN REPLACEMENT KIT



FEATURES

- Genuine OX parts
- Parts kit include parts marked with*

Product Code	Barcode	Suits	Inner Qty	Outer Qty	List Price
OX-P049799	9328217008109	OX-T040308	N/A	6	\$49.63



TRADE OPERATING INSTRUCTIONS & SPARE PARTS

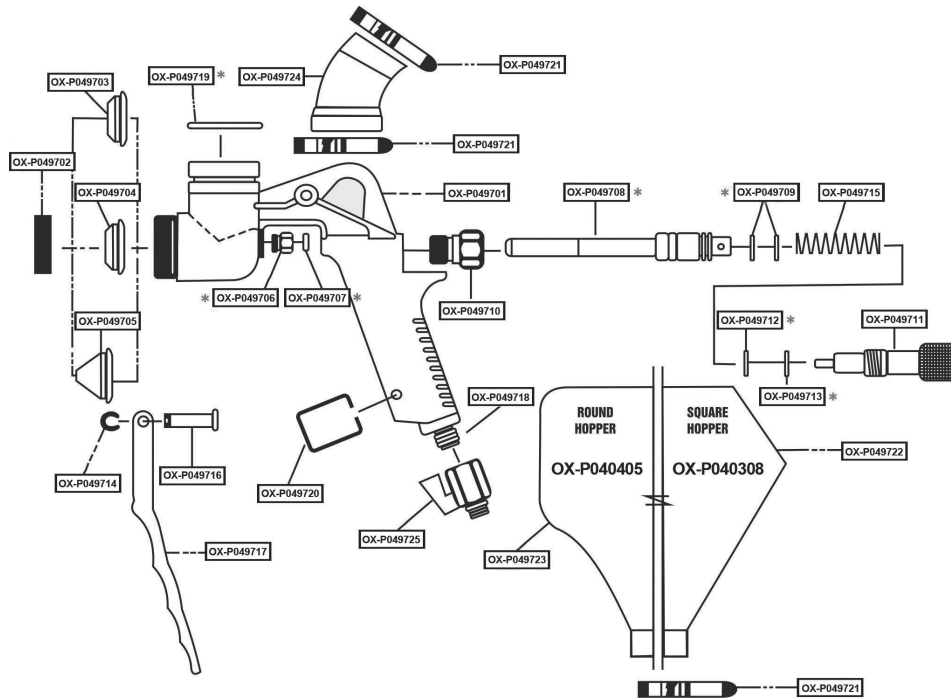

FEATURES

- The 4.0mm & 6.0mm nozzles are suitable for medium viscosity materials.
- The 8.0mm nozzle is suitable for high viscosity materials.
- The size of the drop is controlled by means of the air regulator which can be fitted in the air inlet in the gun body.
- The spray gun is an internal mix type with material gravity fed from the hopper.
- This gun requires a minimum of an 8mm hose line.
- Maximum hopper capacity is 5.5 litres - square or 3.5 litres - round.
- Use with masonry, textured paints & textile wall coatings on medium sizes surfaces.

Product Code	Description	Replacement Parts Kit
OX-P049701	Aluminum Body	Part NO: OX-P049799
OX-P049702	Retaining Ring	Contents:
OX-P049703	4.0mm Nozzle	*1 x Fitting OX-P049706
OX-P049704	6.0mm Nozzle	*1 x O-Ring OX-P049707
OX-P049705	8.0mm Nozzle	*1 x Needle Shaft OX-P049709
OX-P049706	Fitting	*2 x O-Ring OX-P049712
OX-P049707	O-Ring	*1 x Gasket OX-P049713
OX-P049708	Needle Shaft	*1 x O-Ring
OX-P049709	O-Ring	*1 x O-Ring
OX-P049710	Regulator Guide	
OX-P049711	Assembly	
OX-P049712	Gasket	
OX-P049713	O-Ring	
OX-P049714	E-Ring	
OX-P049715	Spring	
OX-P049716	Pin	
OX-P049717	Trigger	
OX-P049718	Connection	
OX-P049719	O-Ring	
OX-P049720	Clip Ring	
OX-P049721	Clamp	
OX-P049722	Plastic Hopper- Square	
OX-P049723	Plastic Hopper- Round	
OX-P049724	45° Elbow	
OX-P049725	On/Off Valve	



OX-P281 1400W MIXING DRILL

FEATURES

- Externally accessible carbon brushes
- 2 speed gearbox for heavy duty applications
- Soft start with constant speed control
- Powerful 1400W motor
- Lightweight
- Electronic variable speed
- Dual ergonomic DURAGRIP 'D' handles
- Replacement Paddle: OX-P121035

Product Code	Barcode	Standard Equipment	Inner Qty	Outer Qty	List Price
OX-P281	9341231033728	160mm Mixing Paddle Wrench, Carrying Case	N/A	N/A	\$310.00

TECHNICAL INFORMATION

Input Power	1400W
No Load Speed Gear 1	150-300RPM
No Load Speed Gear 2	300-650RPM
Spindle	M14
Weight	15kg

12 MONTHS WARRANTY



OX-P282 1800W MIXING DRILL

FEATURES

- Externally accessible carbon brushes
- 2 speed gearbox for heavy duty applications
- Soft start with constant speed control
- Powerful 1800W motor
- Lightweight
- Electronic variable speed
- Dual ergonomic easy grip handles
- Supplied in durable carrying case
- Replacement Paddle: OX-P121035

Product Code	Barcode	Standard Equipment	Inner Qty	Outer Qty	List Price
OX-P282	9341231010255	160mm Mixing Paddle Wrench, Carrying Case	N/A	N/A	\$440.00

TECHNICAL INFORMATION

Input Power	1800W
No Load Speed Gear 1	150-300RPM
No Load Speed Gear 2	300-650RPM
Spindle	M14
Weight	15kg

12 MONTHS WARRANTY



Sturdy carry case
for storage



TRADE MIXING PADDLE – HELICAL WITH RIM

- Zinc plated
- For mixing tile glue, grout etc. - use on high viscosity materials

Product Code	Barcode	Drive	Batch Size	Size	Inner Qty	Outer Qty	List Price
		HEX-mm (Male)					
OX-T120609	9341231015922	8	5 - 15	90 x 500	4	12	\$19.95
OX-T120612	9341231015939	10	20 - -30	120 x 600	4	12	\$27.90

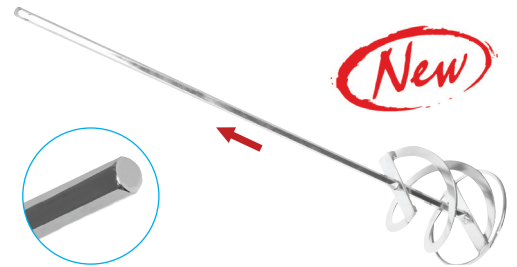

TRADE MIXING PADDLE – NEGATIVE HELIX

- Zinc plated
- For mixing acrylic render with grit, thick paint etc. - use on medium viscosity materials

Product Code	Barcode	Drive	Batch Size	Size	Inner Qty	Outer Qty	List Price
			kg				
OX-T120435	9341231015915	M14	25-40	135 x 650	4	12	\$39.10

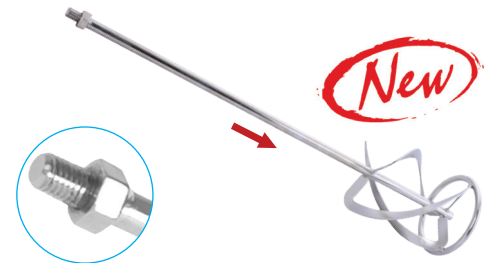

PRO MIXING PADDLE – RIBBON

- Chrome plated
- For mixing paint and general liquids - low to medium viscosity materials

Product Code	Barcode	Drive	Batch Size	Size	Inner Qty	Outer Qty	List Price
		HEX-mm (Male)					
OX-P120308	9341231010842	8	5 - 10	80 x 400	4	12	\$15.04
OX-P120312	9341231010859	10	10 - 15	120 x 600	4	12	\$31.89

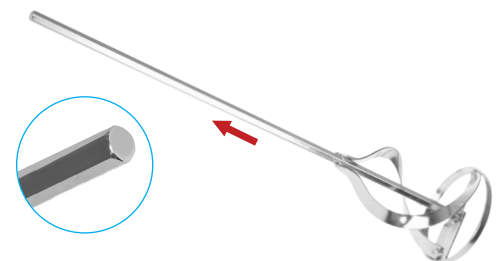

PRO MIXING PADDLE - DUAL FIN

- Chrome plated
- For mixing paint, tile glue, grout etc. - multi-purpose use on low to high viscosity materials

Product Code	Barcode	Drive	Batch Size	Size	Inner Qty	Outer Qty	List Price
		HEX-mm (Male)					
OX-P120809	9341231010927	8	5 - 15	85 x 500	4	12	\$29.86

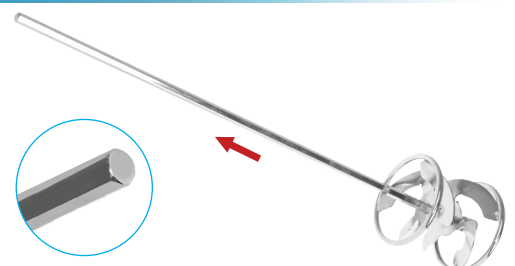



PRO MIXING PADDLE – HELICAL

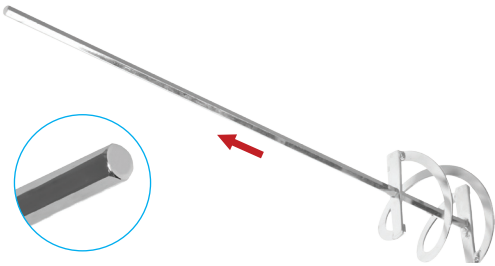

- Chrome plated
- For mixing grout etc. - use on high viscosity materials

Product Code	Barcode	Drive	Batch Size	Size	Inner Qty	Outer Qty	List Price
		HEX-mm (Male)					
OX-P120909	9341231010934	10	5 - 15	90 x 500	4	12	\$20.70
OX-P120913	9341231010941	12	20 - 30	130 x 600	4	12	\$30.20

PRO MIXING PADDLE – HELICAL WITH RIM

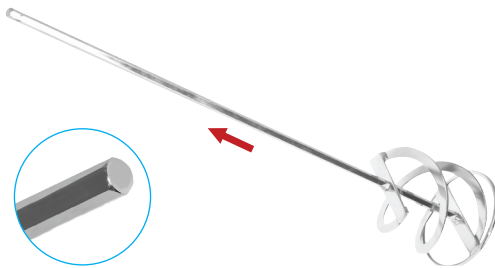

- Chrome plated
- For mixing tile glue, grout etc. - use on high viscosity materials

Product Code	Barcode	Drive	Batch Size	Size	Inner Qty	Outer Qty	List Price
		HEX-mm (Male)					
OX-P120609	9341231010897	8	5 - 15	90 x 500	4	12	\$26.69
OX-P120612	9341231010903	10	20 - 30	120 x 600	4	12	\$39.56

PRO MIXING PADDLE – HELICAL WITH RIM

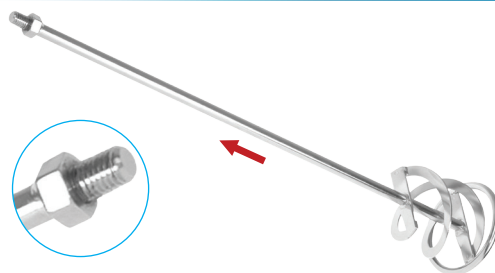

- Chrome plated
- For mixing tile glue, grout etc. - use on high viscosity materials

Product Code	Barcode	Drive	Batch Size	Size	Inner Qty	Outer Qty	List Price
		HEX-mm (Male)					
OX-P121012	9341231010958	M14	20-30	120 x 650	4	12	\$48.27
OX-P121035	9341231010965	M14	30-40	135 x 650	4	12	\$54.74

PRO MIXING PADDLE – NEGATIVE HELIX

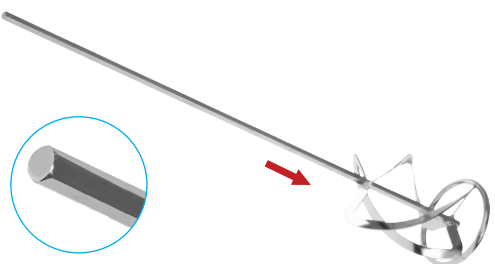

- Chrome plated
- For mixing acrylic render without grit, paint, epoxy etc. - use on low viscosity materials

Product Code	Barcode	Drive	Batch Size	Size	Inner Qty	Outer Qty	List Price
		HEX-mm (Male)					
OX-P120735	9341231010910	12	25-40	135 x 750	4	12	\$46.85



PRO MIXING PADDLE – POSITIVE HELIX

- Chrome plated
- For mixing acrylic render without grit, thick paint - use on high viscosity materials

Product Code	Barcode	Drive	Batch Size	Size	Inner Qty	Outer Qty	List Price
			kg	mm			
OX-P120512	9341231010873	M14	20-30	120 x 650	4	12	\$59.56
OX-P120535	9341231010880	M14	25-40	135 x 650	4	12	\$64.15

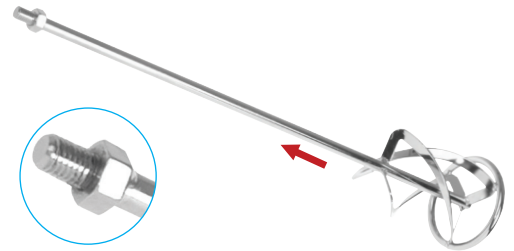

PRO MIXING PADDLE – NEGATIVE HELIX

- Chrome plated
- For mixing acrylic render with grit, thick paint etc. - use on medium viscosity materials

Product Code	Barcode	Drive	Batch Size	Size	Inner Qty	Outer Qty	List Price
			kg	mm			
OX-P120435	9341231010866	M14	25-40	135 x 650	4	12	\$64.15

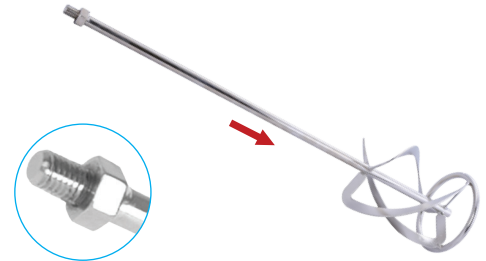

PRO HEAVY DUTY STIRRER

- Chrome plated
- For mixing lime putty plaster

Product Code	Barcode	Drive	Batch Size	Size	Inner Qty	Outer Qty	List Price
			kg	mm			
OX-P120220	9341231010835	M14	55 - 70	200 x 650	4	12	\$66.32

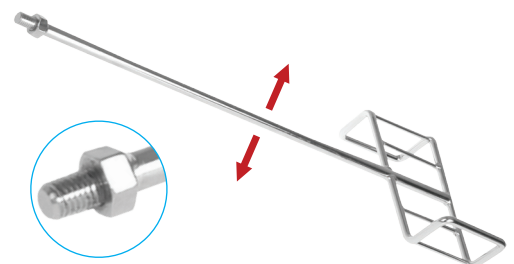

ADAPTOR

- Chrome plated
- For joining male M14 to male M14

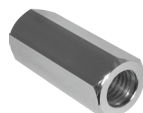

Product Code	Barcode	Description	Inner Qty	Outer Qty	List Price
OX-P121414	9341231011009	M14 Female - M14 Female	N/A	6	\$29.80

EXTENSION

- Chrome plated
- For increasing the length of M14 drive shaft



Product Code	Barcode	Drive	Length	Inner Qty	Outer Qty	List Price
			mm			
OX-P121515	9341231011016	M14	150	N/A	6	\$38.68



Tiling Tools



Tiling is hard work and the OX range has been developed to stand the test of time. Our tiling tools are prized examples of when design innovation meets ultimate performance to achieve the superior finish.

With 5 different style trowels and 4 different notch sizes, we've got a solution for every tiling application.

From the strength of the steel to the perfect weight and balance – our tiling tools symbolize quality. Guaranteed better than the rest.

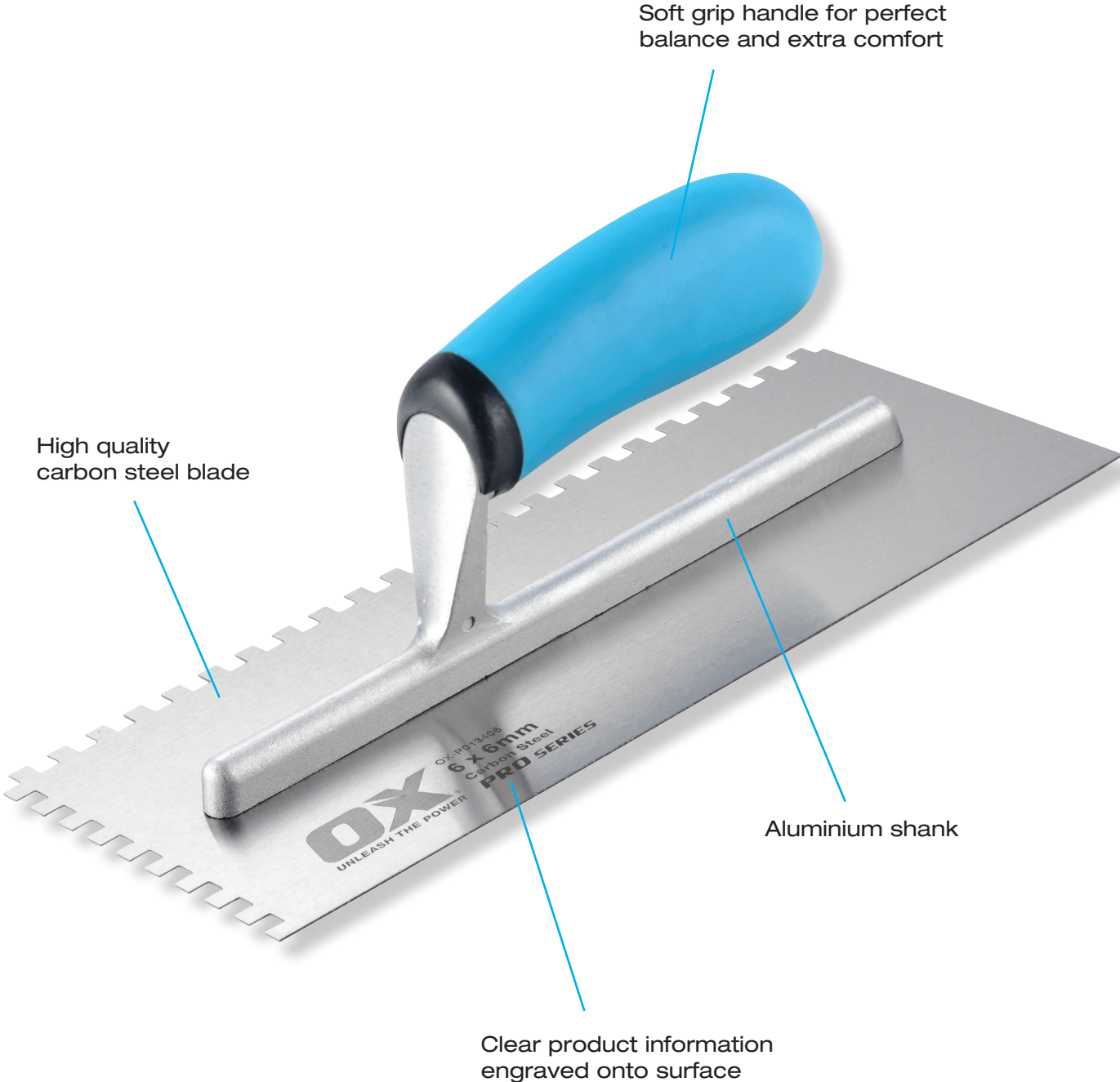



PRO STRAIGHT SET TILE NIPPER – TWO STRAIGHT



FEATURES

- Strong drop forged body
- Cuts round and irregular shapes
- DURAGRIP handles
- Tungsten – solid tip, set in and ground/polished finished

Product Code	Barcode	Size	Inner Qty	Outer Qty	List Price
OX-P152180	9341231029462	8" / 200mm	6	36	\$30.02

PRO STRAIGHT SET TILE NIPPER – TWO CURVED



FEATURES

- Strong drop forged body
- Cuts round and irregular shapes
- DURAGRIP handles
- Tungsten – solid tip, set in and ground/polished finished

Product Code	Barcode	Size	Inner Qty	Outer Qty	List Price
OX-P152280	9341231029479	8" / 200mm	6	36	\$30.02

PRO OFFSET TILE NIPPER – TWO STRAIGHT



FEATURES

- Strong drop forged body
- Cuts round and irregular shapes
- DURAGRIP handles
- Tungsten – solid tip, set in and ground/polished finished

Product Code	Barcode	Size	Inner Qty	Outer Qty	List Price
OX-P151180	9341231029486	8" / 200mm	6	36	\$29.98
OX-P151185	9341231034121	8.5" / 210mm	6	36	\$33.50

PRO OFFSET TILE NIPPER – TWO CURVED



FEATURES

- Strong drop forged body
- Cuts round and irregular shapes
- DURAGRIP handles
- Tungsten – solid tip, set in and ground/polished finished

Product Code	Barcode	Size	Inner Qty	Outer Qty	List Price
OX-P151280	9341231029493	8" / 200mm	6	36	\$30.02
OX-P151285	9341231035753	8.5" / 210mm	6	36	\$33.50



PRO OFFSET TILE NIPPER - ONE CURVED / ONE STRAIGHT

FEATURES

- Strong drop forged body
- Cuts round and irregular shapes
- DURAGRIP handles
- Tungsten – solid tip, set in and ground/polished finished

Product Code	Barcode	Size	Inner Qty	Outer Qty	List Price
OX-P151385	9341231029509	8½" / 210mm	6	36	\$32.84



PRO TILE SCRIBER

FEATURES

- Tungsten tipped
- Chrome plated

Product Code	Barcode	Inner Qty	Outer Qty	List Price
OX-P220208	9341231029585	4	12	\$12.96



PRO PARROT BEAK TILE NIPPER

FEATURES

- Strong drop forged body
- Cuts round and irregular shapes
- DURAGRIP handles
- Tungsten – solid tip, set in and ground/polished finished

Product Code	Barcode	Size	Inner Qty	Outer Qty	List Price
OX-P152475	9341231029516	7½" / 190mm	6	36	\$24.85



TRADE TRIM CUTTER

FEATURES

- Chrome plated
- Integral angle gauge
- Soft moulded hand grips

Product Code	Barcode	Size	Inner Qty	Outer Qty	List Price
OX-T151010	9341231029530	8" / 216mm	4	12	\$58.82





TRADE CROSS SHAPED TILE SPACERS



FEATURES

- Packet of 250pc
- Perfect consistent spacing
- Easy to use

Product Code	Barcode	Size	Inner Qty	Outer Qty	List Price
OX-T160902	9341231040283	2mm	25	100	\$5.39
OX-T160903	9341231040290	3mm	25	100	\$7.04
OX-T160905	9341231040313	5mm	25	100	\$7.92

TRADE WEDGE SHAPED TILE SPACERS



FEATURES

- Strong and durable plastic tile wedges
- 500 pcs per bag

Product Code	Barcode	Notch Size	Inner Qty	Outer Qty	List Price
OX-T160605	9341231029264	6mm	1	100	\$8.16

TRADE ECONOMY NOTCH TROWEL



FEATURES

- Carbon steel blade & ergonomic plastic handle
- Size: 100 x 230mm

Product Code	Barcode	Notch Size	Inner Qty	Outer Qty	List Price
OX-T401704	9341231029677	4 x 4mm	4	12	\$10.49
OX-T401706	9341231029684	6 x 6mm	4	12	\$10.49
OX-T401708	9341231029691	8 x 8mm	4	12	\$10.49
OX-T401710	9341231029707	10 x 10mm	4	12	\$10.49
OX-T401712	9341231029714	12 x 12mm	4	12	\$10.49

TRADE NOTCH TROWEL



FEATURES

- Carbon steel blade & timber handle
- Aluminium shank
- Size: 115 x 280mm

Product Code	Barcode	Notch Size	Inner Qty	Outer Qty	List Price
OX-T401803	9341231038075	3 "v" mm	4	12	\$19.92
OX-T401804	9341231029721	4 "v" mm	4	12	\$22.44



TRADE NOTCH TROWEL

FEATURES

- Carbon steel blade & timber handle
- Aluminium shank
- Size: 115 x 100mm

Product Code	Barcode	Notch Size	Inner Qty	Outer Qty	List Price
OX-T401806	9341231040078	6 x 6mm	4	12	\$19.31
OX-T401808	9341231040085	8 x 8mm	4	12	\$19.31
OX-T401810	9341231040092	10 x 10mm	4	12	\$19.31
OX-T401812	9341231040108	12 x 12mm	4	12	\$19.31



TRADE NOTCH TROWEL

FEATURES

- Rubber grip handle
- Carbon steel blade
- Size: 120 x 280mm
- Square notches

Product Code	Barcode	Notch Size	Inner Qty	Outer Qty	List Price
OX-T403104	9341231040078	4 x 4mm	6	36	\$12.10
OX-T403106	9341231040085	6 x 6mm	6	36	\$12.10
OX-T403108	9341231040092	8 x 8mm	6	36	\$12.10
OX-T403110	9341231040108	10 x 10mm	6	36	\$12.10



PRO NOTCH TROWEL

FEATURES

- Carbon steel blade & aluminium shank
- DURAGRIP handle
- Size: 115 x 280mm

Product Code	Barcode	Notch Size	Inner Qty	Outer Qty	List Price
OX-P013406	9341231029776	6 x 6mm	4	12	\$19.84
OX-P013408	9341231029783	8 x 8mm	4	12	\$19.84
OX-P013410	9341231029790	10 x 10mm	4	12	\$19.84
OX-P013412	9341231029806	12 x 12mm	4	12	\$19.84



PRO NOTCH TROWEL - EXTRA LONG

FEATURES

- Carbon steel blade & aluminium shank
- DURAGRIP handle
- Size: 115 x 356mm

Product Code	Barcode	Notch Size	Inner Qty	Outer Qty	List Price
OX-P407210	9341231038051	10 x 10mm	4	12	\$23.13
OX-P407212	9341231038068	12 x 12mm	4	12	\$23.13

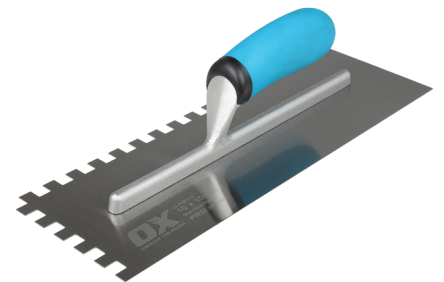



PRO GAUGING TROWEL



FEATURES

- Welded shank
- Precision taper ground blade
- DURAGRIP handle
- 'S' style shank - will 'hang' on the side of a bucket

Product Code	Barcode	Size	Inner Qty	Outer Qty	List Price
OX-P011407	5060242330261	3½ x 7" / 88 x 178mm	4	12	\$17.92
OX-P011408	9341231010804	3½ x 8" / 95 x 203mm	4	12	\$20.27

PRO SQUARE FRONT TROWEL



FEATURES

- High quality carbon steel blade
- DURAGRIP handle
- Forged shank - trowel hangs on the side of a bucket

Product Code	Barcode	Size	Inner Qty	Outer Qty	List Price
OX-P013718	5060242330506	123 x 93 / 180mm (L)	4	12	\$25.94
OX-P013720	9341231022517	135 x 105 / 200mm (L)	4	12	\$28.25

PRO GROUT REMOVER



FEATURES

- Tungsten carbide tipped blade
- Ergonomic body and grip - with blade storage compartment in the hilt
- Size: 210mm

Product Code	Barcode	Blade Size	Inner Qty	Outer Qty	List Price
OX-P130201	9341231029899	50mm	4	16	\$19.58

- Replacement blades
- Tungsten carbide tipped blade
- Suits OX-P130201

Product Code	Barcode	Blade Size	Inner Qty	Outer Qty	List Price
OX-P139801	9341231029905	50mm	6	36	\$15.54



TRADE WALL SCRAPER

FEATURES

- Strips various product off many surfaces

Product Code	Barcode	Blade Size	Inner Qty	Outer Qty	List Price
OX-T050604	9341231013980	100mm	4	12	\$14.40
OX-T050606	9341231026010	150mm	4	12	\$24.28

- Replacement blades
- 5 blades per pack

Product Code	Barcode	Blade Size	Inner Qty	Outer Qty	List Price
OX-T059504	9341231036255	100mm	6	18	\$7.67
OX-T059506	9341231013997	150mm	6	18	\$14.91



PRO HEAVY DUTY SCRAPER

FEATURES

- Chrome plated shaft
- Triple screw blade clamp
- Power weighed DURAGRIP end
- Size: 450mm

Product Code	Barcode	Blade Size	Inner Qty	Outer Qty	List Price
OX-P050105	9341231029912	5" / 127mm	4	12	\$51.15

- Replacement blades - 10pk
- Made from high quality carbon steel
- Suits OX-P050105

Product Code	Barcode	Size	Inner Qty	Outer Qty	List Price
OX-P059905	9341231029929	127 x 19 x 1mm	6	18	\$27.45



PRO TUNGSTEN CARBIDE GRIT HALF ROUND FILE

FEATURES

- With handle
- Double sided - flat and 1/2 round
- Fine (80 grit)

Product Code	Barcode	Size	Inner Qty	Outer Qty	List Price
OX-P070455	9341231029561	250mm	4	12	\$20.65





PRO TILERS LEVEL - 2 VIAL

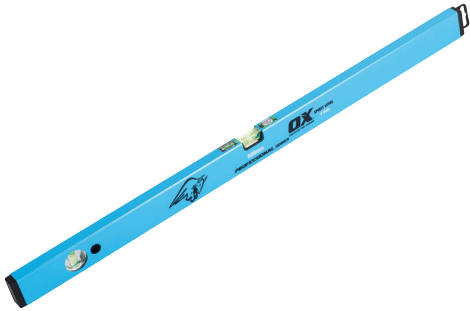

FEATURES

- Magnified centre vial
- Made from structural aircraft alloy
- Plexiglass shock proof vials
- Accuracy +/- 0.5mm/m

Product Code	Barcode	Length	Inner Qty	Outer Qty	List Price
OX-P021203	9341231030031	300mm	3	6	\$42.68
OX-P021204	9341231030046	400mm	3	6	\$45.85
OX-P021206	9341231030055	600mm	3	6	\$56.87
OX-P021208	9341231030062	800mm	3	6	\$63.80
OX-P021210	9341231030079	1000mm	3	6	\$67.98

PRO TILERS LEVEL - 3 VIAL

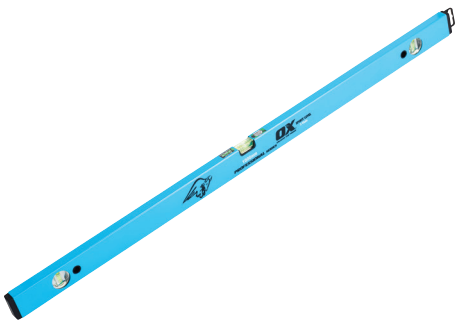

FEATURES

- Magnified centre vial
- Made from structural aircraft alloy
- Plexiglass shock proof vials
- Accuracy +/- 0.5mm/m

Product Code	Barcode	Length	Inner Qty	Outer Qty	List Price
OX-P023110	9341231030086	1000mm	3	6	\$77.99
OX-P023112	9341231030093	1200mm	3	6	\$92.85
OX-P023115	9341231030109	1500mm	3	6	\$107.09
OX-P023118	9341231030116	1800mm	3	6	\$126.34
OX-P023120	9341231030123	2000mm	3	6	\$141.08

PRO 7 PIECE TILERS SET – COMPLETE TILERS LEVEL SET

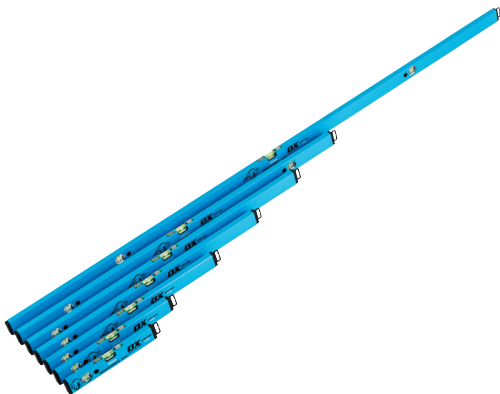

FEATURES

- Magnified centre vial
- Made from structural aircraft alloy
- Plexiglass shock proof vials
- Accuracy +/- 0.5mm/m
- 2 Vials: 300mm x 1, 400mm x 1, 600mm x 1, 800mm x 1, 1000mm x 1
- 3 Vials: 1200mm x 1, 2000mm x 1

Product Code	Barcode	Content	Inner Qty	Outer Qty	List Price
OX-P21SET7	9341231030130	7 pieces	N/A	4	\$400.03



PRO SHAPING TEMPLATE

FEATURES

- Water proof
- Integrated ruler
- 100's of thin plastic 'fingers' move to give a perfect replication of shapes when needed for: tiling, joinery, pattern making and much more



Product Code	Barcode	Size	Inner Qty	Outer Qty	List Price
OX-P020410	9341231029936	4 x 10" / 100 x 255mm	4	12	\$59.40

PRO SINGLE CUP RUBBER SUCTION LIFTER

FEATURES

- Easy single handed use
- Grips on to any smooth flat surface
- Easy to use - press-on for suction - lift lipped edge for release
- Max lift capacity 20kg



Product Code	Barcode	Cup Size	Inner Qty	Outer Qty	List Price
OX-P170403	9341231029943	3" / 80mm	4	8	\$15.98

PRO SINGLE CUP SUCTION LIFTER

FEATURES

- Heavy duty design - ergonomic aluminium 'D' grip
- Grips on to any smooth flat surface
- Easy to use - press-on for suction - lift 'T' release valve to let go
- Max lift capacity 25kg



Product Code	Barcode	Size	Inner Qty	Outer Qty	List Price
OX-P170504	9341231029950	5" / 125mm	2	6	\$66.00

PRO DOUBLE CUP SUCTION LIFTER

FEATURES

- Ergonomic aluminium handle bar
- Grips on to any smooth flat surface
- Quick action - suction 'ON/OFF' levers
- Max lift capacity 35kg



Product Code	Barcode	Size	Inner Qty	Outer Qty	List Price
OX-P170524	9341231029967	4 1/2" / 115mm	2	6	\$96.97



PRO TRIPLE CUP SUCTION LIFTER



FEATURES

- Aluminium grip & body
- Rigid triple head design
- Grips on to any smooth flat surface
- Quick action - suction 'ON/OFF' levers
- Max lift capacity 100kg

Product Code	Barcode	Size	Inner Qty	Outer Qty	List Price
OX-P170534	9341231029974	5" / 125mm	N/A	4	\$140.36

PRO PUMP-UP SUCTION LIFTER – PLASTIC HANDLE



FEATURES

- Plastic workings
- Pump action suction activation
- Grips on to any smooth flat surface
- Sturdy steel construction with high carrying capacity for heavy loads
- Max lift capacity 100kg

Product Code	Barcode	Size	Inner Qty	Outer Qty	List Price
OX-P170808	9341231029981	8" /200mm	N/A	4	\$240.63

PRO PUMP-UP SUCTION LIFTER – BRASS HANDLE



FEATURES

- Brass workings
- Pump action suction activation
- Grips on to any smooth flat surface
- Sturdy steel construction with high carrying capacity for heavy loads
- Max lift capacity 150kg

Product Code	Barcode	Size	Inner Qty	Outer Qty	List Price
OX-P170708	9341231029998	8" /200mm	N/A	4	\$274.40



PRO POINTED RUBBER GROUTER

FEATURES

- Traditional timber handle
- Foam-rubber blade with steel insert - for rigidity

Product Code	Barcode	Size	Inner Qty	Outer Qty	List Price
OX-P011995	9341231029844	3½ x 9½" / 86 x 240mm	4	12	\$24.08



PRO RECTANGULAR DOUBLE RUBBER GROUTER

FEATURES

- Ergonomic plastic handle
- Gum rubber blade with bevelled edges
- Plastic backer with foam cushion for even pressure

Product Code	Barcode	Size	Inner Qty	Outer Qty	List Price
OX-P011895	9341231029868	4 x 9½" / 100 x 240mm	4	12	\$26.53
OX-P011812	9341231029875	4 x 12" / 100 x 300mm	4	12	\$30.73



PRO GENERAL PURPOSE SPONGE

FEATURES

- All-purpose type sponge for general cleaning
- Coarse pore for removal of heavy dirt
- Consists of large and small cell structure

Product Code	Barcode	Size	Inner Qty	Outer Qty	List Price
OX-P250311	9341231030154	110 x 165 x 65mm	6	24	\$8.22
OX-P250313	9341231030161	130 x 200 x 70mm	6	24	\$8.32





PRO HYDRO HAND SPONGE



FEATURES

- The ultimate tilers sponge - made from 'Hydro' material for ultimate water holding properties
- 'Open cell' design with the 'Hydro' material, creates the most effective dirt release during 'compression load deflection'

Product Code	Barcode	Size	Inner Qty	Outer Qty	List Price
OX-P250411	9341231030178	110 x 165 x 65mm	6	24	\$10.40
OX-P250413	9341231030185	130 x 200 x 70mm	6	24	\$12.82

PRO SLOTTED HYDRO SPONGE



FEATURES

- The ultimate tilers sponge - made from 'Hydro' material for ultimate water holding properties
- Open cell design with the 'Hydro' material, creates the most effective dirt release during 'compression load deflection'
- The OX slotted surface design creates multiple edges to perform the cleanest 'wipe' after one swipe

Product Code	Barcode	Size	Inner Qty	Outer Qty	List Price
OX-P250113	9341231030192	200 x 130 x 50mm	6	24	\$14.89

PRO VELCRO SPONGE HOLDER



FEATURES

- One piece handle and blade with co-moulded DURAGRIP
- Velcro quick change base - glued and stapled

Product Code	Barcode	Size	Inner Qty	Outer Qty	List Price
OX-P012927	9341231030208	5 x 10 1/2" / 130 x 270mm	4	12	\$35.70

PRO VELCRO SLOTTED HYDRO SPONGE



FEATURES

- The ultimate tilers sponge - made from 'Hydro' material for ultimate water holding properties
- Open cell design with the 'Hydro' material, creates the most effective dirt release during 'compression load deflection'
- The OX slotted surface design creates multiple edges to perform the cleanest 'wipe' after one swipe

Product Code	Barcode	Size	Inner Qty	Outer Qty	List Price
OX-P250215	9341231030215	6 x 12 x 1 1/2" / 150 x 300 x 35mm	6	24	\$29.35



PRO SLOTTED HYDRO SPONGE FLOAT

FEATURES

- One piece moulded handle and blade
- Sponge made from 'Hydro' material for ultimate water holding properties
- Open cell design



Product Code	Barcode	Size	Inner Qty	Outer Qty	List Price
OX-P404814	9341231035104	5½ x 11" / 140 x 280mm	4	12	\$30.49

TRADE TILE WASH KIT

FEATURES

- Ergonomic Handgrip
- Triple Roller System
- Swivel Castors for easy manoeuvrability
- Large 24L container made of impact resistant plastic

Product Code	Barcode	Size	Inner Qty	Outer Qty	List Price
OX-T140424	9341231040320	24L	1	6	\$101.82



Posters available. See Page 223.





Striking Tools



OX hammers are full of features to make them perfectly balanced and built to last.

Shock absorbing ergonomically designed handles reduce hand fatigue and vibration. The quality of the steel, the balance and comfort grip handles mean they are perfect for tradesmen who want the job done right, first time every time.



Forged, one piece steel construction

Precision balanced

Ergonomically designed grip reduces fatigue and allows for multiple grip positions

Non-slip grip with shock reduction

Premium grade, polished and heat treated steel



PRO CLAW HAMMER



FEATURES

- Non-slip grip handle with shock reduction
- Precision balanced
- Forged, one piece steel construction
- High quality steel for durability

Product Code	Barcode	Size	Inner Qty	Outer Qty	List Price
OX-P080116	5060242337994	16oz / 450g	4	24	\$47.02
OX-P080120	5060242337401	20oz / 560g	4	24	\$50.14
OX-P080124	5060242338007	24oz / 680g	4	24	\$64.36

LIFETIME GUARANTEE

PRO FRAMING HAMMER



FEATURES

- Straight claw hammer designed for frame work
- Long handle for greater impact
- Non-slip grip handle with shock reduction
- Forged, one piece steel construction
- Precision balanced

Product Code	Barcode	Size	Inner Qty	Outer Qty	List Price
OX-P082328	5060242338014	28oz / 790g	4	16	\$73.09

LIFETIME GUARANTEE

PRO BRICK HAMMER



FEATURES

- Accurately ground chisel end for clean cutting
- Non-slip grip handle with shock reduction
- Forged, one piece steel construction
- Precision balanced

Product Code	Barcode	Size	Inner Qty	Outer Qty	List Price
OX-P082424	5060242338021	24oz / 790g	4	24	\$62.64

LIFETIME GUARANTEE



TRADE BRICK HAMMER

FEATURES

- Hardened and tempered steel head
- Solid core fibreglass handle
- Ergonomic rubber grip
- Head weight 24oz

Product Code	Barcode	Handle Length	Inner Qty	Outer Qty	List Price
OX-T081024	9341231013638	340mm	4	24	\$26.02



PRO ROCK PICK

FEATURES

- Accurately ground point end for accurate picking
- Non-slip grip handle with shock reduction
- Forged, one piece steel construction
- Precision balanced

Product Code	Barcode	Size	Inner Qty	Outer Qty	List Price
OX-P083222	9341231035074		4	24	\$57.75



LIFETIME GUARANTEE

PRO DRYWALL HAMMER

FEATURES

- Crowned, scored hammer head to reduce the chance of impact marks on plasterboard
- Cutaway and notched cutting blade for withdrawing nails and cutting laths
- Non-slip grip handle with shock reduction

Product Code	Barcode	Size	Inner Qty	Outer Qty	List Price
OX-P082614	5060242338038	14oz / 400g	4	24	\$57.42



LIFETIME GUARANTEE

PRO FIBREGLASS CLAW HAMMER

FEATURES

- Fibreglass shaft with an injection moulded grip
- Non-slip grip with shock reduction
- Precision balanced

Product Code	Barcode	Size	Inner Qty	Outer Qty	List Price
OX-P081620	5060242337451	20oz / 570g	4	24	\$34.59



LIFETIME GUARANTEE



TRADE FIBREGLASS CLAW HAMMER

FEATURES

- Hardened and tempered steel head
- Solid core fibreglass handle
- Ergonomic rubber grip

Product Code	Barcode	Size	Inner Qty	Outer Qty	List Price
OX-T080920	9341231013652	20oz / 560g	4	24	\$18.73



PRO CLUB HAMMER

FEATURES

- Forged, one piece steel construction
- Non-slip grip handle with shock reduction
- High quality steel for durability

Product Code	Barcode	Size	Inner Qty	Outer Qty	List Price
OX-P082703	5060242338045	3lb / 1.3kg	4	12	\$57.42
OX-P082704	5060242338052	4lb / 1.8kg	4	12	\$62.64



LIFETIME GUARANTEE

PRO FIBREGLASS CLUB HAMMER

FEATURES

- DURAGRIP Handle
- High quality drop forged steel head
- Fibreglass handle

Product Code	Barcode	Size	Inner Qty	Outer Qty	List Price
OX-P080425	9341231001963	2.5lb / 1.15kg	2	16	\$52.50





TRADE FIBREGLASS CLUB HAMMER

FEATURES

- Hardened high quality steel
- Extremely strong fibreglass handle
- Available in 3LB & 4LB

Product Code	Barcode	Size	Inner Qty	Outer Qty	List Price
OX-T081303	9341231013645	3lb / 1.3kg	2	18	\$22.69
OX-T081304	5060242332241	4lb / 1.8kg	2	18	\$27.68



PRO HICKORY HANDLE CLUB HAMMER

FEATURES

- Hardened high quality steel
- Genuine hickory handle
- Available in 2.5LB

Product Code	Barcode	Size	Inner Qty	Outer Qty	List Price
OX-P080325	9341231001956	2.5lb / 1.15kg	2	16	\$57.37



TRADE FIBREGLASS DEMOLITION HAMMER

FEATURES

- Hardened and tempered steel head
- Solid core fibreglass handle
- Ergonomic rubber grip

Product Code	Barcode	Size	Inner Qty	Outer Qty	List Price
OX-T082004	9341231013676	4lb / 1.8kg	4	18	\$32.74





TRADE FIBREGLASS SLEDGE HAMMER



FEATURES

- Hardened high quality steel
- Extremely strong fibreglass handle
- Available in 7LB, 10LB, 12LB & 14LB

Product Code	Barcode	Size	Inner Qty	Outer Qty	List Price
OX-T081507	5060242332258	7lb / 3.2kg	N/A	2	\$59.93
OX-T081510	5060242332265	10lb / 4.5kg	N/A	2	\$63.95
OX-T081512	9341231013720	12lb / 5.4kg	N/A	2	\$72.74
OX-T081514	5060242332272	14lb / 6.3kg	N/A	2	\$79.63

PRO HICKORY HANDLE SLEDGE HAMMER



FEATURES

- Hardened high quality steel
- Genuine hickory handle
- Fitted with steel wedges

Product Code	Barcode	Size	Inner Qty	Outer Qty	List Price
OX-P080204	9341231001918	4lb / 1.8kg	N/A	2	\$45.00
OX-P080207	9341231001925	7lb / 3.2kg	N/A	2	\$71.24
OX-P080210	9341231001932	10lb / 4.5kg	N/A	2	\$94.14
OX-P080214	9341231001949	14lb / 6.3kg	N/A	2	\$115.24

PRO ONE PIECE RUBBER MALLET



FEATURES

- White non marking rubber
- Steel reinforcement core
- Comfortable grip
- One piece moulded rubber

Product Code	Barcode	Size	Inner Qty	Outer Qty	List Price
OX-P080605	9341231011726	17.5oz / 500g	2	12	\$47.11
OX-P080610	9341231011733	35oz / 1000g	2	12	\$61.37

TRADE BLACK RUBBER MALLET



FEATURES

- Quality, durable rubber mallet
- Solid core fibreglass handle
- Ergonomic rubber grip

Product Code	Barcode	Size	Inner Qty	Outer Qty	List Price
OX-T081724	5060242332296	24oz / 680g	2	12	\$16.33
OX-T081732	5060242332302	32oz / 907g	2	12	\$19.89



PRO SINGLE ENDED SCUTCH HAMMER

FEATURES

- Hickory handle
- High quality drop forged steel head
- Head weight 28oz

Product Code	Barcode	Handle Length	Inner Qty	Outer Qty	List Price
OX-P080528	9341231001901	240mm	4	24	\$53.87



PRO DOUBLE ENDED SCUTCH HAMMER

FEATURES

- High quality drop forged steel head
- Head weight 22oz
- Hickory handle

Product Code	Barcode	Handle Length	Inner Qty	Outer Qty	List Price
OX-P080522	9341231001895	340mm	4	24	\$63.06

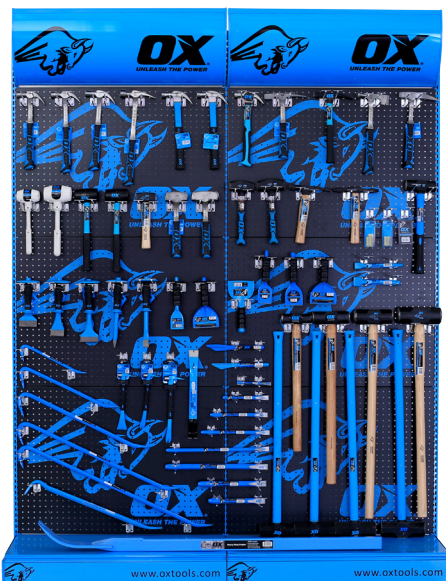

Ranges and Posters available.
See page 208 and 223.





Measuring Tools



Few tools are as widely used across the world as the tape measure.

We at OX recognise that, and build our tapes to last the test of time. Durability, reliability and innovation are the words we think of when designing a new line of tapes.

OX has enhanced its reputation as a leading tape measure manufacturer with the launch of the new Pro Series short tape, which boasts an impressive 2.8M stand out whilst remaining an extremely compact design.



Comfortable grip and slip resistant hold

Easy slide thumb lock

Extra tough double nylon coated steel blade

Brighter blade for easy reading

Compact design tape measure

Impressive 2.1M standout

3 rivet end hook for ultimate strength



PRO STAINLESS STEEL TAPE MEASURE

New

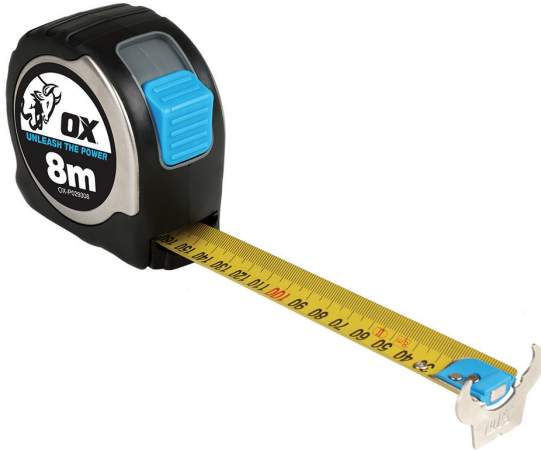

FEATURES

- Professional tape measure
- Stainless steel case with over mould for heavy duty use
- Extra tough nylon coated steel 27mm wide blade
- 3.0m stand out
- Large End hook
- Easy Access thumb lock

Product Code	Barcode	Size	Inner Qty	Outer Qty	List Price
OX-P029308	9341231015519	8M	12	48	\$32.52

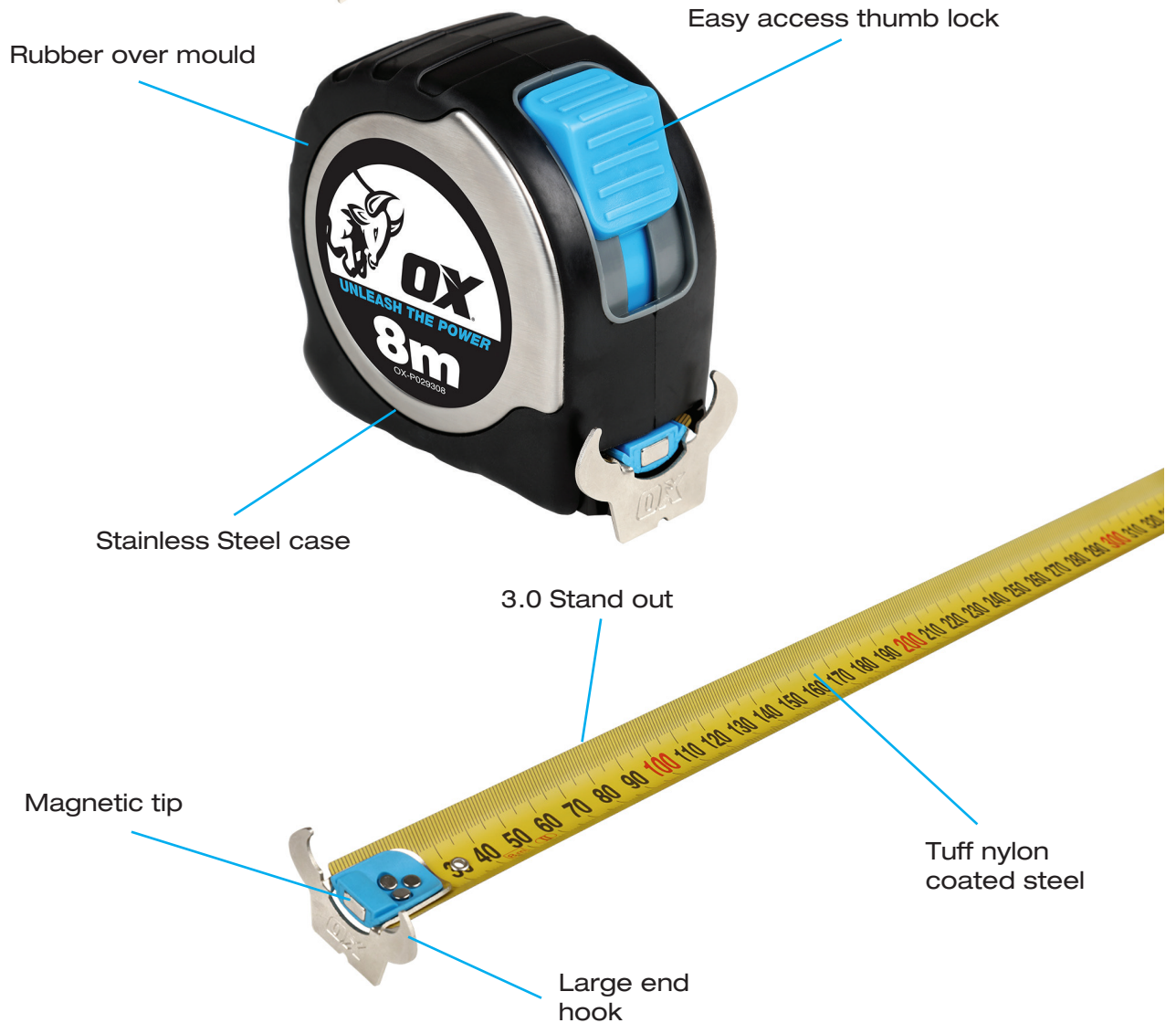



PRO POWER TAPE MEASURE

FEATURES

- DURAGRIP moulded rubber case
- Triple rivetted hook end
- 25mm wide metric blade

Product Code	Barcode	Blade Size	Inner Qty	Outer Qty	List Price
OX-P020108	9341231000706	8M	18	36	\$21.19



*Free counter display with every purchase of 18pcs.

TRADE POWER TAPE

FEATURES

- Wide 25mm metric blade
- Ergonomic rubber grip
- Nylon coated steel blade
- Easy access sliding thumb lock
- Shock absorbing blade return bumper
- Quick release button

Product Code	Barcode	Size	Inner Qty	Outer Qty	List Price
OX-T020108	9341231032349	8M	12	48	\$13.06
OX-T020110	9341231034008	10M	12	48	\$17.41





TRADE OPEN REEL TAPE

FEATURES

- High impact ABS plastic case
- Quick winding mechanism
- Ergonomic rubber grip



Product Code	Barcode	Size	Inner Qty	Outer Qty	List Price
OX-T023503	9341231010668	30M	4	12	\$41.75
OX-T023505	9341231010675	50M	4	12	\$64.41
OX-T023510	9341231010682	100M	4	12	\$139.96

PRO COMBINATION SQUARE

FEATURES

- High quality cast and machined sliding stock
- Stainless steel rule engraved with metric graduations
- Can mark 90° and 45° with adjustable depth for repetition marking and scribing
- 305mm size



Product Code	Barcode	Size	Inner Qty	Outer Qty	List Price
OX-P500530	9341231015793	300mm	1	30	\$25.95

PRO HEAVY DUTY ALUMINIUM 'T' SQUARE

FEATURES

- Made from high quality silver anodised structural aircraft aluminium
- Precise 'mm' - graduation markings
- Quadruple rivetted 'T' end to ensure accuracy for a long time

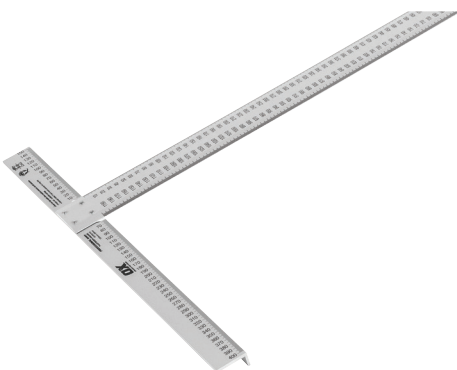

Product Code	Barcode	Size	Inner Qty	Outer Qty	List Price
OX-P021114	9341231032158	50x16" / 1200x550mm	1	4	\$112.57



PRO CARPENTER'S SQUARE

FEATURES

- Metric markings with writing area for notes
- Heavy duty carbon steel
- Epoxy coated

Product Code	Barcode	Size	Inner Qty	Outer Qty	List Price
OX-P021064	9341231032172	24x16" / 600x400mm	4	12	\$24.66

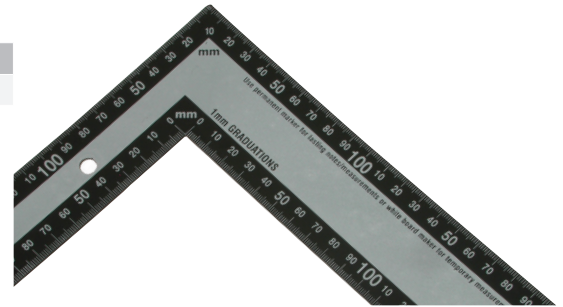

Ranges available.
See page 202.





Layout Tools



Lifetime vial warranty, 30mm depth extrusion and patented innovative dual view vials are just some of the features on the extraordinary OX Pro Series level.

This one is definitely stronger than an OX – and if you can find a tougher level we will give you your money back...Guaranteed!



Dual view vials give the unique front view of the vertical vial – for more precise leveling, and an end to neck & eye strain

Magnified vial for better readability

Life time vial warranty

Shock-proof polypropylene & TPR end caps with air cushioned PVC shock absorbers



Air cushioned grip handles with soft touch feel

High quality aluminium extrusion
66mm (w) x 30mm (d)

Vials individually calibrated to an accuracy of 0.005"/" (0.5mm/m)



PRO SPIRIT LEVEL

FEATURES

- The strongest level EVER or your money back!
- Unique dual view
- Silicone air cushioned handles
- Shock proof end caps
- Two milled surfaces
- One horizontal and two vertical vials



Product Code	Barcode	Size	Inner Qty	Outer Qty	List Price
OX-P024406	5060242333897	600mm	4	40	\$80.67
OX-P024408	5060242333903	800mm	4	40	\$81.64
OX-P024409	5060242333910	900mm	4	40	\$85.65
OX-P024410	5060242333927	1000mm	4	40	\$89.43
OX-P024412	5060242333934	1200mm	4	40	\$97.46
OX-P024418	5060242333941	1800mm	4	40	\$137.15
OX-P024420	5060242333958	2000mm	4	40	\$165.64
OX-P024424	5060242333965	2400mm	4	40	\$191.66



Displays stands and posters available.
See page 209 & 223.





PRO SPIRIT LEVEL WITH MAGNETS

FEATURES

- The strongest level EVER or your money back!
- Unique dual view
- Silicone air cushioned handles
- Shock proof end caps
- Two milled surfaces
- One horizontal and two vertical vials
- Rare-earth magnets for an extra strong grip on any metal surface



Rare-earth magnets for an extra strong grip on any metal



Product Code	Barcode	Size	Inner Qty	Outer Qty	List Price
OX-P024306	5060242338861	600mm	4	40	\$95.85
OX-P024312	5060242338903	1200mm	4	40	\$111.10
OX-P024320	5060242338910	2000mm	4	40	\$173.08

PRO TORPEDO LEVEL

FEATURES

- The toughest torpedo level in the world!
- Tilted horizontal vial for direct view of bubble
- 3 unbreakable acrylic shock-proof vials
- Accuracy <math><0.0005\text{"/"}</math> (0.5mm/m)
- 25mm thick profile – extremely strong construction
- Fine milled surface with V-groove



Product Code	Barcode	Size	Inner Qty	Outer Qty	List Price
OX-P027210	5060242338632	250mm	6	18	\$63.93

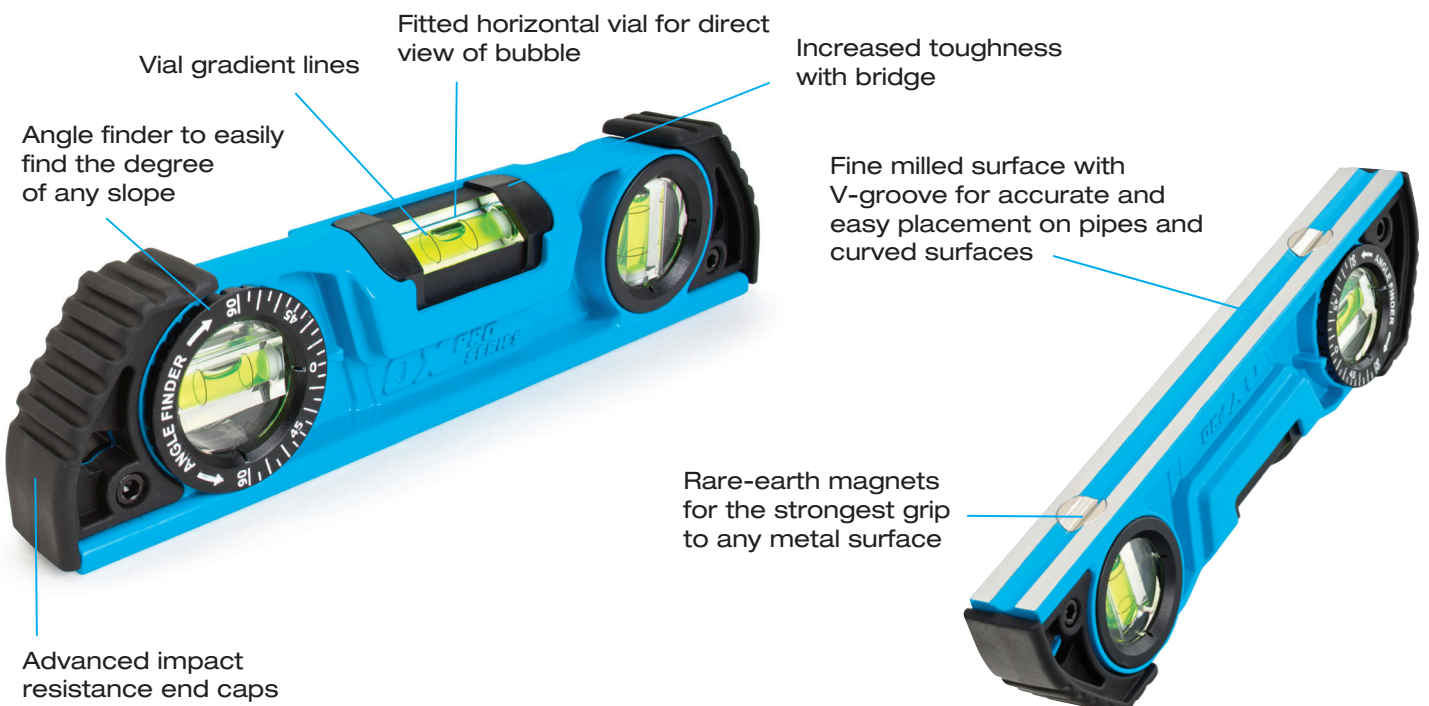



TRADE TORPEDO LEVEL – 230MM



New

20
BOX



FEATURES

- Light weight trade torpedo level
- 3 easy to read vials (horizontal, vertical, 45 degrees)
- Magnetic V-groove for pipe work and scaffolding
- Tough rubber end caps

Product Code	Barcode	Size	Inner Qty	Outer Qty	List Price
OX-T026323	9341231040214	230mm	20	80	\$14.24

PRO CHALK LINE REEL

New



FEATURES

- Heavy duty construction
- 5:1 Gear ratio for fast rewind
- 30M Chalkline length
- Twisted polyester string for strength and durability

Product Code	Barcode	Size	Inner Qty	Outer Qty	List Price
OX-P027730	5060242338861	100ft/30m	4	40	\$32.99

PRO HEAVY DUTY CHALK LINE REEL



FEATURES

- Extra heavy duty die-case steel construction
- Self chalking reel to mark straight lines in layout
- Streamline ergonomic case

Product Code	Barcode	Size	Inner Qty	Outer Qty	List Price
OX-P020830	9341231001291	100ft / 30m	4	12	\$25.76



PRO ALUMINIUM CHALK LINE REEL

FEATURES

- Durable zinc alloy case
- Self locking winder handle
- Easy slide fill operation

Product Code	Barcode	Size	Inner Qty	Outer Qty	List Price
OX-P020330	9341231011023	100ft / 30m	4	12	\$15.11



PRO LINE MARKING CHALK

FEATURES

- Contractors grade
- Long lasting
- High visibility

Product Code	Barcode	Size	Inner Qty	Outer Qty	List Price
OX-T025001	9341231025600	115g Red	4	12	\$5.00
OX-T025002	93412310256217	115g White	4	12	\$5.00
OX-T025003	9341231025624	115g Blue	4	12	\$5.00
OX-T025004	9341231025631	115g Yellow	4	12	\$5.00
OX-T025007	9341231025662	225g Red	4	12	\$7.98
OX-T025008	9341231025679	225g White	4	12	\$7.98
OX-T025009	9341231025686	225g Blue	4	12	\$7.98
OX-T025010	9341231025693	225g Yellow	4	12	\$7.98
OX-T025013	9341231025723	1kg Blue	4	12	\$24.98
OX-T025014	9341231025730	1kg Red	4	12	\$24.98



TRADE LUMBER CRAYONS - 12 PACK

FEATURES

- Hexagonal profile - 13 x 113MM
- Will not dry out
- Waterproof
- For marking timber, concrete, bitumen, tyres, etc.

Product Code	Barcode	Colour	Inner Qty	Outer Qty	List Price
OX-T024701	9341231025747	Yellow	4	12	\$19.27
OX-T024702	9341231025754	Blue	4	12	\$19.27
OX-T024703	9341231025761	Green	4	12	\$19.27
OX-T024704	9341231025778	Red	4	12	\$19.27
OX-T024705	9341231025785	Black	4	12	\$19.27
OX-T024706	9341231025792	White	4	12	\$19.27





Woodworking Tools



Owning quality woodworking tools says a lot about how serious a woodworker you are.

Superbly balanced chisels and built tough bar clamps are products that have been designed to give users greater control and accuracy.

The OX pro heavy duty clamp has been created for more demanding work where high-force tension, strength and durability are required.



Removable protective pads

Swivel jaw for even distribution of clamping pressure and capabilities to clamp uneven surfaces

90mm Throat depth

Very fast change from clamp to spreader

Heat treated steel bar

Reinforced nylon & steel construction for ultimate strength

150kg clamping force





PRO HEAVY DUTY BAR CLAMP



FEATURES

- Very heavy duty construction for durability
- High clamping force – 150kg
- Quick change conversion from clamp to spreader
- TPR Jaw pads protect surfaces from damage
- Available in 5 sizes

Product Code	Barcode	Size	Inner Qty	Outer Qty	List Price
OX-P201206	5060242338786	6" / 150mm	2	6	\$41.54
OX-P201212	5060242338793	12" / 300mm	2	6	\$47.32
OX-P201218	5060242338809	18" / 450mm	2	6	\$54.20
OX-P201224	5060242338816	24" / 600mm	2	6	\$60.86
OX-P201236	5060242338823	36" / 900mm	2	6	\$72.99

PRO HEAVY DUTY BAR CLAMP



FEATURES

- Heavy duty
- Exceptionally strong
- Removable non marking face pads
- Very high clamping force – 350kg
- Steel construction

Product Code	Barcode	Size	Inner Qty	Outer Qty	List Price
OX-P200506	9341231001093	6" / 150mm	2	6	\$33.98
OX-P200512	9341231001109	12" / 300mm	2	6	\$37.81
OX-P200518	9341231001116	18" / 450mm	2	6	\$44.13
OX-P200524	9341231001123	24" / 600mm	2	6	\$50.46
OX-P200536	9341231001130	36" / 900mm	2	6	\$64.13

PRO STANDARD BAR CLAMP

Whilst Stocks Last



FEATURES

- Soft TPR jaw pads protect surfaces from damage
- Nylon & fibreglass body for strength
- High quality carbon steel bar
- Quick change conversion from clamp to spreader without need of tools

Product Code	Barcode	Size	Inner Qty	Outer Qty	List Price
OX-P200706	5060242335655	6" / 150mm	2	6	\$40.81
OX-P200712	5060242335662	12" / 300mm	2	6	\$51.83
OX-P200718	5060242335679	18" / 450mm	2	6	\$56.91
OX-P200724	5060242335686	24" / 600mm	2	6	\$60.67
OX-P200736	5060242335693	36" / 900mm	2	6	\$77.00



PRO SOLID STEEL DOOR CLAMP

FEATURES

- Solid steel, fully welded
- Holds door during attaching hinges, routing, hanging, rebating
- Comfortable soft grip handles
- Felt covered jaws for protection against door damage
- Fits all doors – from 18mm 'built in' doors to 65mm 'fire rated' doors

Product Code	Barcode	Size	Inner Qty	Outer Qty	List Price
OX-P200101	9341231001994	49cm x 30cm	2	6	\$208.69



TRADE CARPENTER'S PENCILS - 10PK

FEATURES

- Traditional shape chamfered rectangle
- Ideal for marking saw cuts
- High quality lead
- FREE sharpener included

Product Code	Barcode	Type	Inner Qty	Outer Qty	List Price
OX-T022910	5060135479916	Red / Medium	12	48	\$9.46
OX-T023010	9341231035012	Green / Hard	12	48	\$9.46



TRADE CARPENTER'S PENCILS - 72 PK

FEATURES

- Traditional shape chamfered rectangle
- Ideal for marking saw cuts
- High quality lead

Product Code	Barcode	Size	Inner Qty	Outer Qty	List Price
OX-T022972	5060135479947	Red / Medium	N/A	8	\$63.32
OX-T023072	9341231025808	Green / Hard	N/A	8	\$63.32





PRO SNAP OFF CARPENTERS PENCIL



FEATURES

- Unique retractable carpenters pencil
- 9mm Carbon fibre blade always sharp for accurate marking
- Wooden grip
- Easily extend and retract the graphite marking blade

Product Code	Barcode	Size	Inner Qty	Outer Qty	List Price
OX-P500601	5060359915429	-	1	12	\$9.95

PRO SNAP OFF REPLACEMENT BLADES



FEATURES

- Snap off replaceable pencil blades for the snap off carpenters pencil
- 9mm Carbon fibre blade always sharp for accurate marking
- These blades will fit most 9mm snap off knives
- Pack of 3 blades

Product Code	Barcode	Size	Inner Qty	Outer Qty	List Price
OX-P500703	5060359915436	-	1	12	\$10.82

PRO WOOD CHISEL



FEATURES

- Hardened & tempered high grade steel for durability
- Soft grip non-slip handle
- Precision balanced
- Strike end cap
- Size etched into blade

Product Code	Barcode	Size	Inner Qty	Outer Qty	List Price
OX-P370406	5060242334870	6mm / 1/4"	4	12	\$22.94
OX-P370410	5060242334894	10mm / 3/8"	4	12	\$22.94
OX-P370413	5060242334900	13mm / 1/2"	4	12	\$22.94
OX-P370416	5060242334931	16mm / 5/8"	4	12	\$23.30
OX-P370419	5060242334948	19mm / 3/4"	4	12	\$23.30
OX-P370422	5060242334962	22mm / 7/8"	4	12	\$25.84
OX-P370425	5060242334979	25mm / 1"	4	12	\$25.84
OX-P370432	5060242334993	32mm / 1-1/4"	4	12	\$25.84
OX-P370438	5060242335006	38mm / 1-1/2"	4	12	\$27.29



PRO WOOD CHISEL SET

FEATURES

- Steel shaft for ultimate strength
- DURAGRIP handle for total control
- Metal striking cap
- Special hardened chrome vanadium
- Comes with heavy duty plastic carry case



Product Code	Barcode	Size	Inner Qty	Outer Qty	List Price
OX-P370105	5060242333644	6, 13, 19, 25 & 32mm	2	8	\$70.40

PRO 7 PIECE SCREWDRIVER SET

FEATURES

- Chrome vanadium steel bar
- Soft grip handle moulded directly to shaft for ultimate strength
- Colour coded handles
- Robust, heavy duty case
- Set includes: Flared 6.5 x 150mm; Parallel 3.5 x 75mm & 5.5 x 125mm; Philips PH1 x 100mm, PH2 x 125mm; Pozi PZ1 X 100mm, PZ2 x 125mm



Product Code	Barcode	Size	Inner Qty	Outer Qty	List Price
OX-P360207	5060242339318	7 Pc	N/A	10	\$60.58

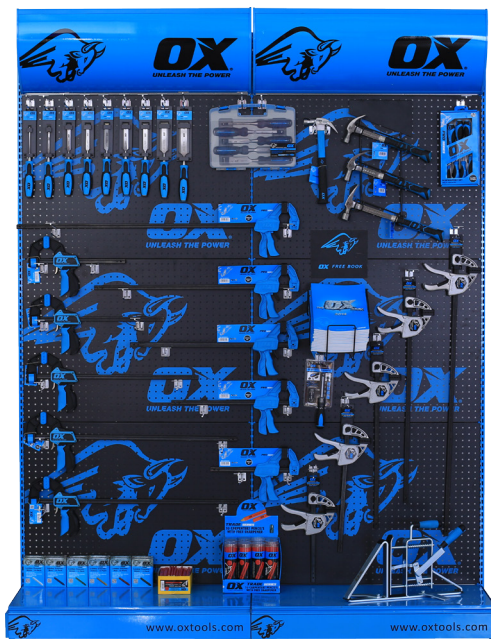

Ranges and Posters available.
See page 202 & 223.





OX-P225 1800W CIRCULAR SAW 185mm



TECHNICAL INFORMATION

Input Power	1800W
No Load Speed	5000RPM
Blade Diameter	185mm x 20mm (B)
Max Capacity at 90Deg	63mm
Max Capacity at 45Deg	49mm
Weight	5.1kg

FEATURES

- Magnesium alloy construction for durability
- Rapid bevel adjustment for accurate cutting
- Ergonomic design with front bail handle
- Powerful 1800W motor enough power for the toughest jobs
- Height adjustment for precision work
- Beveling to 55 degrees for increased diversity of applications
- Laser guidance for precise work
- Lightweight only 5.1kg for easy handling

Product Code	Barcode	Standard Equipment	Inner Qty	Outer Qty	List Price
OX-P225	9341231023118	TCT Sawblade (30T), Hex Key and Parallel Guide	1	2	\$176.36

12 MONTH WARRANTY

OX-P226 2300W CIRCULAR SAW 235mm



TECHNICAL INFORMATION

Input Power	2300W
No Load Speed	4500RPM
Blade Diameter	235mm x 25mm (B)
Max Capacity at 90Deg	82mm
Max Capacity at 45Deg	58mm
Weight	7.4kg

FEATURES

- Magnesium alloy construction for durability
- Micro bevel adjustment for accurate cutting
- Ergonomic design with front bail handle
- Powerful 2300W motor enough power for the toughest jobs
- Rack & pinion height adjustment for precision work
- Beveling to 47 degrees for increased diversity of applications
- Laser guidance for precise work
- Micro depth adjustment allows up to 6mm of fine tuning

Product Code	Barcode	Standard Equipment	Inner Qty	Outer Qty	List Price
OX-P226	9341231023125	TCT Sawblade (40T), Hex Key and Parallel Guide	1	2	\$260.36

12 MONTH WARRANTY



OX-P230 600W PENDULUM JIGSAW

FEATURES

- Ergonomic design with soft coated grip for optimum comfort
- All ball bearing construction for durability
- Equipped with connecto for dust extraction
- Lightweight - only 3.0kg for easy handling
- Powerful 600W mother enough power for the toughest jobs
- 3 + 1 pendulum adjustment for increased cutting performance
- Bevel adjustment to 45 degrees for accurate cutting

Product Code	Barcode	Standard Equipment	Inner Qty	Outer Qty	List Price
OX-P230	9341231023132	2pcs Sawblade for wood, 1pc Sawblade for steel, Parallel Guide, Dust Collection adapter, Hex Key	1	2	\$161.18

12 MONTH WARRANTY



TECHNICAL INFORMATION

Input Power	600W
No Load Speed	800-3000/min
Blade Type	T Shank
Max Capacity in wood	110mm
Max Capacity in steel	10mm
Weight	3.0kg

OX-P240 710W UNLIMITED REBATE PLANER

FEATURES

- 12mm rebate capacity
- Superior blade design for perfect finish and efficiency
- Ergonomic design with handle for increased control
- Powerful 710W motor
- Side fence for improved control & stability
- Left or right dust extraction
- Lightweight - only 3.1kg for easy handling

Product Code	Barcode	Standard Equipment	Inner Qty	Outer Qty	List Price
OX-P240	9341231023156	Parallel Fence, Spare Drive Belt, Dust Extraction Adapter	1	4	\$170.91

12 MONTH WARRANTY



TECHNICAL INFORMATION

Input Power	710W
No Load Speed	16000/min
Blade Type	82mm
Max Capacity in wood	0-2.6mm
Max Capacity in steel	12mm
Weight	3.1kg

OX-P245 MULTI PURPOSE TOOL

FEATURES

- Ideal for sawing, scraping and sanding
- Supplied with accessories
- Ergonomic design for optimum working comfort
- Powerful 250W motor
- Variable speed for precise machine control
- Magnesium gearbox for durability
- Lightweight - only 1.3kg for easy handling

Product Code	Barcode	Standard Equipment	Inner Qty	Outer Qty	List Price
OX-P245	9341231023163	1 Plunge Cut Blade, 1 Velcro Sanding Base Plate, 1 Scraping Knife, 1 Hex Key, 2pcs Fixing Bolts and Fixing rings	1	1	\$148.50

12 MONTH WARRANTY



TECHNICAL INFORMATION

Input Power	250W
No Load Speed	8000-17000/min
Weight	1.3kg



Cutting Tools



Tradesmen demand a lot from their cutting tools. Our utility knives and saws are designed for ease of use, so that you can change blades without extra tools, cut faster, cut longer and cut hours off your day!

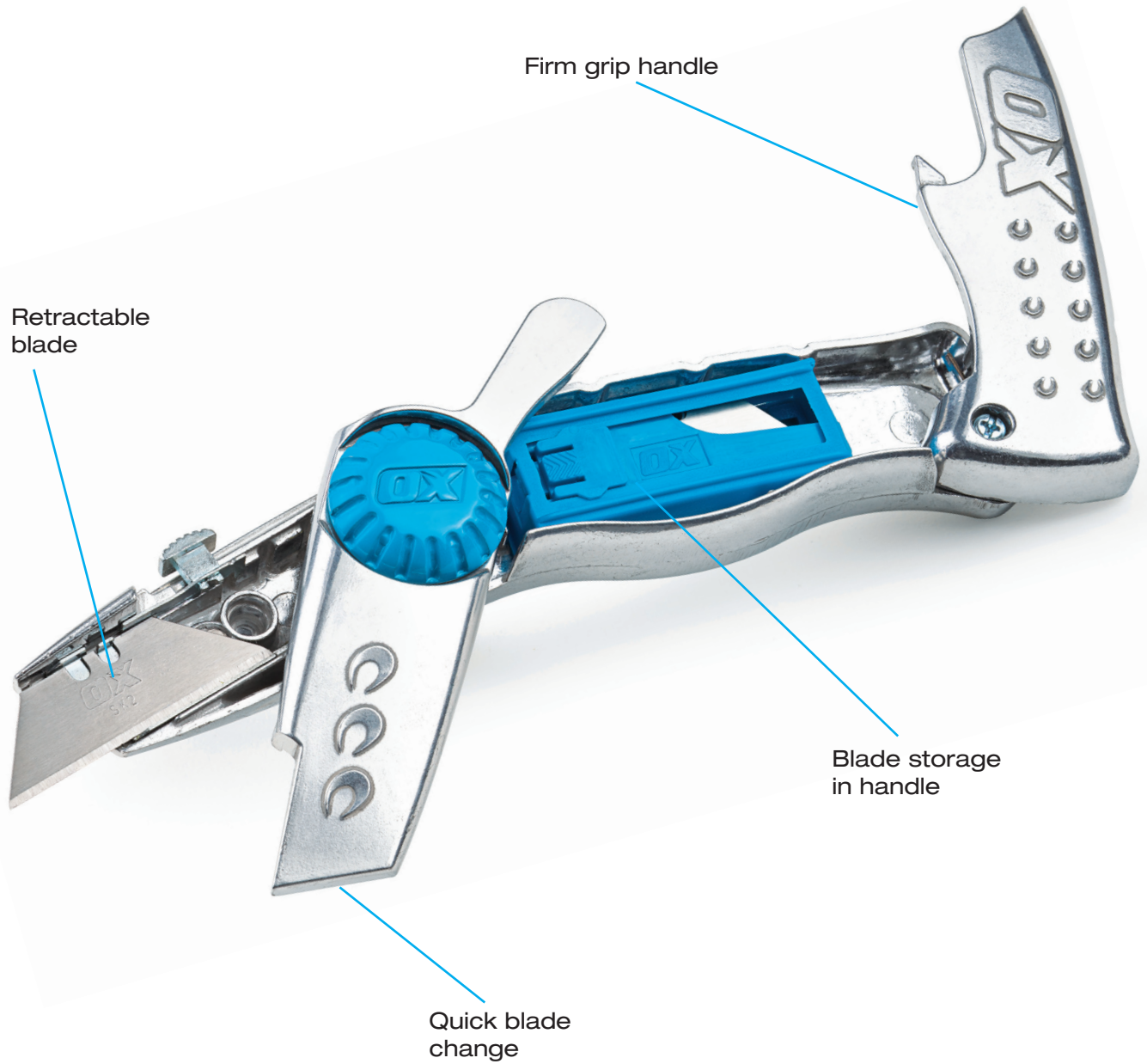



Cutting Tools

PRO HEAVY DUTY TRIMMING KNIFE



FEATURES

- Quick blade changing - accepts most standard utility blades
- Firm grip handle
- Magnetic tip
- Storage for blade dispenser - 10 blades included

Product Code	Barcode	Inner Qty	Outer Qty	List Price
OX-P220310	5060242335259	4	12	\$25.85

PRO RETRACTABLE FOLDING KNIFE



FEATURES

- Non-slip ergonomic grip
- Very fast blade change
- Compact foldable design
- Blade storage in handle
- Comes with 2 x spare blades
- Retractable blade

Product Code	Barcode	Inner Qty	Outer Qty	List Price
OX-P221001	5060242338731	4	12	\$32.84

PRO SNAP OFF KNIFE



FEATURES

- Patent pending design and functions
- Magazine style blade storage
- Auto reloading
- End of grip tip can be pulled out to snap off the blades

Product Code	Barcode	Inner Qty	Outer Qty	List Price
OX-P220901	9341231032387	4	12	\$21.98

■ Replacement blades

Product Code	Barcode	Inner Qty	Outer Qty	List Price
OX-P221510	9341231032394	4	12	\$9.01

TRADE TRIMMING KNIFE



FEATURES

- Tough metal construction
- Accepts most standard utility blades
- Blade storage in handle
- Retractable blade

Product Code	Barcode	Inner Qty	Outer Qty	List Price
OX-T220601	5060242335853	4	12	\$10.18



PRO FIXED FOLDING KNIFE

FEATURES

- Compact foldable design
- Blade storage in handle
- Very fast blade change

Product Code	Barcode	Inner Qty	Outer Qty	List Price
OX-P221301	5060242339349	12	72	\$21.98

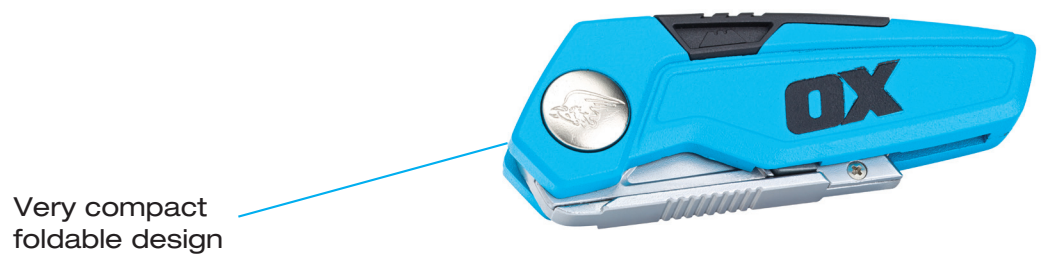



Cutting Tools

PRO SOFT GRIP UTILITY KNIFE



FEATURES

- Sleek “flipout” blade storage cartridge in the back of the handle for extra blades
- Quick blade change – “push the button”
- Ergonomic grip for ease of use
- Dual cutting position

Product Code	Barcode	Inner Qty	Outer Qty	List Price
OX-P220801	9341231032370	4	12	\$19.21

PRO SELF RETRACTING UTILITY KNIFE



FEATURES

- Solid cast construction
- Dual slider – left and right hand use
- Auto retracting blade
- Quick blade change

Product Code	Barcode	Inner Qty	Outer Qty	List Price
OX-P221101	9341231032424	4	12	\$10.34

PRO REPLACEMENT KNIFE BLADES

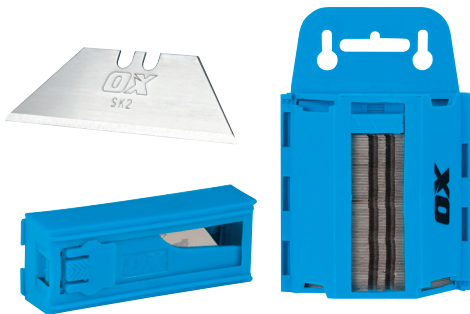

FEATURES

- Superior industrial grade blade
- Special heat treatment
- Fits most standard utility knives
- Dispenser pack, keeps blades clean and safe

Product Code	Barcode	Size	Inner Qty	Outer Qty	List Price
OX-P222010	5060242332159	10 Pack	4	12	\$9.92
OX-P222110	5060242332364	100 Pack	4	12	\$54.36

TRADE FIBRO CUTTER

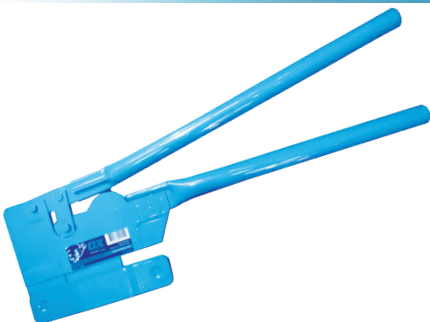

FEATURES

- Steel handles
- Ergonomic handle design
- Easy to use
- Clean cut

Product Code	Barcode	Capacity	Inner Qty	Outer Qty	List Price
OX-T230401	9341231013010	3/8" / 10mm	4	12	\$61.60



PRO HAND SAW

FEATURES

- Ultimate Ergonomic soft grip handle for extreme comfort and increased power
- Triple ground and impulse harder teeth for aggressive cutting and longer life
- Improved stability for faster cutting
- Integral 45 and 90 degree angles built into handle.
- Suitable for Universal cutting
- 8 teeth per inch, 1mm blade thickness



Product Code	Barcode	Size	Inner Qty	Outer Qty	List Price
OX-P133255	5060359914101	22" / 550mm	6	36	\$33.72

PRO HIGH TENSION JACK SAW

FEATURES

- Quick change blade design
- Bi grip rubber handle
- Blade in either 45° / 90° cut position
- No tools needed to change blade



Product Code	Barcode	Size	Inner Qty	Outer Qty	List Price
OX-P130730	5060242331640	12" / 300mm	4	16	\$49.58

PRO MINI HACKSAW

FEATURES

- Bi grip rubber handle
- 6 blade angle settings
- Industrial strength hacksaw



Product Code	Barcode	Size	Inner Qty	Outer Qty	List Price
OX-P130815	5060242331657	6" / 150mm	4	16	\$15.94



PRO 12" (300MM) HACKSAW BLADES



FEATURES

- Suit OX-P130730 hacksaw
- Cuts aluminium, iron, copper, carbon steel and hard plastic
- Pack of 4 blades
- Smooth cuts

Product Code	Barcode	Size	Inner Qty	Outer Qty	List Price
OX-P131318	5060242331879	18 TPI PACK 4	6	36	\$10.80
OX-P131324	5060242331886	24 TPI PACK 4	6	36	\$10.80
OX-P131332	5060242331916	32 TPI PACK 4	6	36	\$10.80

PRO 6" HACKSAW BLADES – 24TPI



FEATURES

- Cuts aluminium, iron, copper, carbon steel and hard plastic
- Pack of 10 blades
- Suits OX-P130815 hacksaw

Product Code	Barcode	Size	Inner Qty	Outer Qty	List Price
OX-P131424	5060242331893	24 TPI PACK 10	6	36	\$10.70

PRO MASONRY SAW



FEATURES

- 750mm carbide tipped
- 34 tungsten carbide tipped teeth
- Suitable for lightweight concrete

Product Code	Barcode	Size	Inner Qty	Outer Qty	List Price
OX-P133034	9328217006105	750mm	2	6	\$162.44



TRADE JAB SAW WITH HOLSTER

FEATURES

- Supplied with protective holster for safety when not in use
- Hardened & tempered steel blade for increased life
- 8 Teeth per inch
- Non-slip ergonomic handle
- Excellent for wood, plastic & drywall



Product Code	Barcode	Size	Order Qty	Box Qty	List Price
OX-T131516	5060242338717	6.5" / 165mm	1	10	\$27.47

PRO AVIATION SNIPS

FEATURES

- Heat treated alloy jaws
- Fully adjustable and replaceable jaws
- Rated to cut HRC49
- Max cut 1.5mm mild steel / 0.9 stainless steel



Product Code	Barcode	Cut Direction	Inner Qty	Outer Qty	List Price
OX-P231001	9341231032448	Left	4	12	\$30.89
OX-P231002	9341231032455	Right	4	12	\$30.89
OX-P231003	9341231032462	Straight	4	12	\$30.89



Posters available. See Page 223.





Demolition Tools

The OX demolition range is a very impressive line up.

The handles are shaped and sized to provide comfort in the hand with shock absorbing technology.

The materials and construction are of the highest quality to stand up to an unbelievable amount of force. Only heavy use can really demonstrate the power and resistance of these tools.



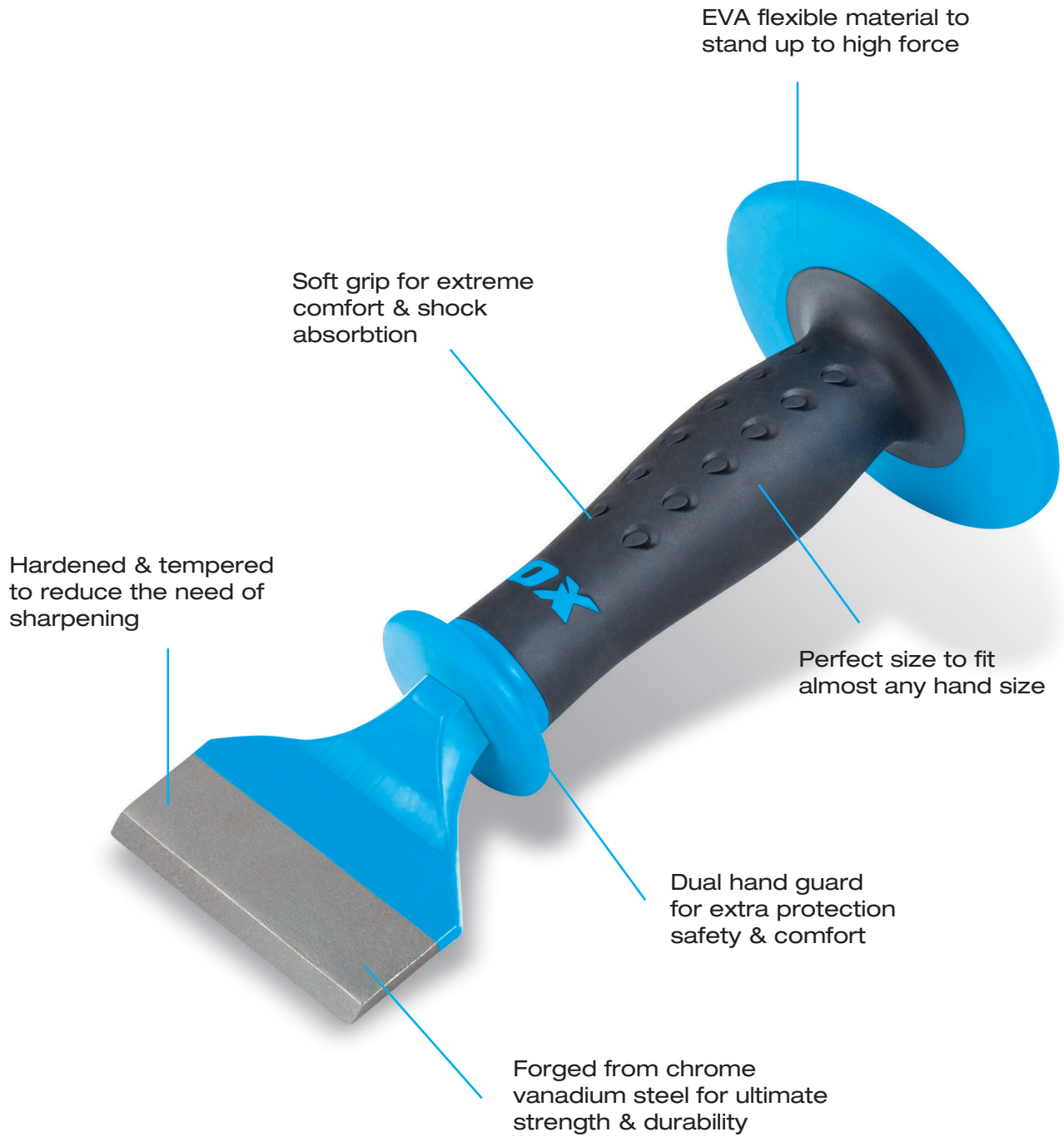



PRO CLAW BAR

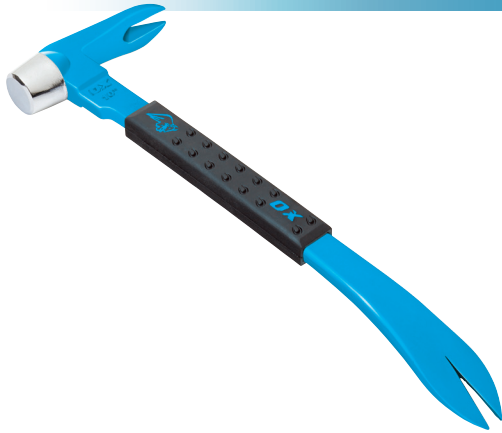

FEATURES

- Unique hammer head
- Multi-functional claw bar for striking, prying & pulling
- Comfort non-slip grip handle
- Polished bevelled claw for better access

Product Code	Barcode	Size	Inner Qty	Outer Qty	List Price
OX-P083010	5060242339981	10" / 250mm	4	12	\$32.21
OX-P083012	5060242338069	12" / 300mm	4	12	\$39.88



PRO MOULDING BAR

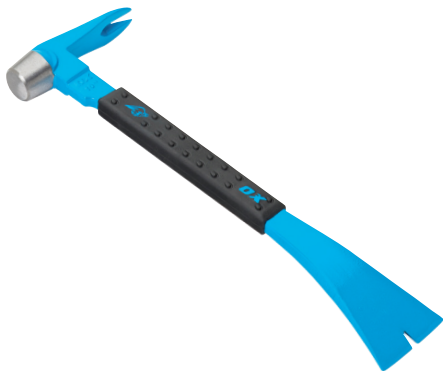

FEATURES

- Unique hammer head
- Multi-functional moulding bar with extra wide chisel blade
- Comfort non-slip grip handle
- Polished bevelled claw for better access

Product Code	Barcode	Size	Inner Qty	Outer Qty	List Price
OX-P083110	5060242338076	10" / 250mm	4	12	\$35.71





PRO ELECTRICIAN'S CHISEL

FEATURES

- Forged chrome vanadium steel
- Dual hand guard
- Soft grip handle
- For cutting & trimming of wood, wallboard & masonry

Product Code	Barcode	Blade Width	Inner Qty	Outer Qty	List Price
OX-P092002	5060242334573	2 1/4" / 57mm	4	16	\$31.90



PRO FLOOR CHISEL

FEATURES

- Forged chrome vanadium steel
- Dual hand guard
- Soft grip handle
- For cutting, prying & ripping of nails & hard wood flooring

Product Code	Barcode	Blade Width	Inner Qty	Outer Qty	List Price
OX-P092103	5060242334542	3" / 76mm	4	16	\$31.90



PRO COLD CHISEL

FEATURES

- Forged chrome vanadium steel
- Dual hand guard
- Soft grip handle
- For cutting & shaping iron, steel, aluminium, copper, brass, nuts & bolts

Product Code	Barcode	Blade Width	Inner Qty	Outer Qty	List Price
OX-P092401	5060242334566	1" / 25mm	4	16	\$29.70





PRO BRICK BOLSTER



FEATURES

- Forged chrome vanadium steel
- Dual hand guard
- Soft grip handle
- For cutting & splitting of bricks & masonry

Product Code	Barcode	Blade Width	Inner Qty	Outer Qty	List Price
OX-P092303	5060242334511	3" / 76mm	4	16	\$31.90

TRADE ELECTRICIANS BOLSTER



FEATURES

- Drop forged steel
- Rubber grip handle

Product Code	Barcode	Blade Width	Inner Qty	Outer Qty	List Price
OX-T090502	5060242331497	2¼" / 57mm	4	8	\$12.54

TRADE BRICK BOLSTER



FEATURES

- Drop forged steel
- DURAGRIP handle

With Hand Guard

Product Code	Barcode	Blade Width	Inner Qty	Outer Qty	List Price
OX-T090945	5060242332227	4½" / 115mm	4	8	\$18.98



PRO CONCRETE CHISEL – 3/4" x 12"

FEATURES

- Forged chrome vanadium steel
- Dual hand guard
- Soft grip handle
- For cutting & breaking of concrete

Product Code	Barcode	Size	Inner Qty	Outer Qty	List Price
OX-P092501	5060242334535	3/4" x 12" / 20 x 300mm	4	16	\$29.70



TRADE COLD CHISEL

FEATURES

- One piece forged steel for ultimate strength
- Hardened & tempered for durability
- For cutting & shaping masonry

Product Code	Barcode	Size	Inner Qty	Outer Qty	List Price
OX-T090110	5060242330858	1" X 10" / 25 X 250mm	4	8	\$10.69
OX-T090112	5060242330865	1" X 12" / 25 X 300mm	4	8	\$12.98
OX-T090118	5060242330872	1" X 18" / 25 X 450mm	4	8	\$17.62
OX-T091206	5060242331442	1/2" X 6" / 13 X 150mm	4	12	\$2.75
OX-T091208	5060242331459	3/4" X 8" / 20 X 200mm	4	12	\$6.11
OX-T091210	5060242331466	3/4" X 10" / 20 X 250mm	4	12	\$5.74
OX-T091212	5060242331473	3/4" X 12" / 20 X 300mm	4	12	\$6.22
OX-T091218	5060242331480	3/4" X 18" / 20 X 450mm	4	12	\$9.92



PRO GROOVED PLUGGING CHISEL

FEATURES

- High quality carbon steel
- Hexagonal shaft
- Fluted design - to prevent 'jamming'
- Chamfered striking end

Product Code	Barcode	Size	Inner Qty	Outer Qty	List Price
OX-P090210	9341231022395	250 x 6mm	4	16	\$22.02





PRO HANDY BAR



FEATURES

- Heat treated, forged steel
- For pulling, lifting or prying
- Powder coated to provide maximum resistance to rusting

Product Code	Barcode	Size	Inner Qty	Outer Qty	List Price
OX-P093015	5060242338083	16" / 390mm	4	16	\$36.23

PRO HEAVY DUTY PRY BAR



FEATURES

- Powder coated finish all steel
- Hardened steel claw
- Ideal for prying formwork

Product Code	Barcode	Size	Inner Qty	Outer Qty	List Price
OX-P092856	9341231025846	56" / 1425mm	4	16	\$182.38

TRADE WRECKING BAR

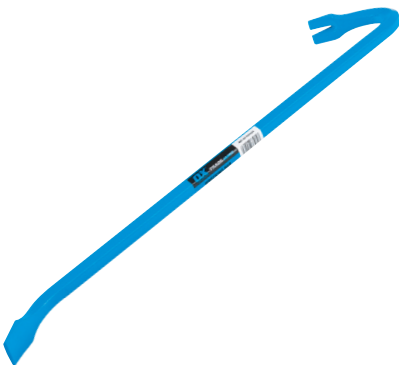

FEATURES

- Solid steel wrecking bar
- Forged high carbon steel - one piece

Product Code	Barcode	Size	Inner Qty	Outer Qty	List Price
OX-T091012	5060242330803	12" / 300mm	3	6	\$11.77
OX-T091018	5060242330810	18" / 450mm	3	6	\$19.67
OX-T091024	5060242330827	24" / 600mm	3	6	\$27.48
OX-T091030	5060242331503	30" / 750mm	3	6	\$35.38
OX-T091036	5060242330834	36" / 900mm	3	6	\$43.19



PRO HEAVY DUTY WRECKING BAR

FEATURES

- Forged high carbon steel for incredible strength
- Slotted claw for pulling & prying nails
- Impressive powder coated finish
- Extremely heavy duty

Product Code	Barcode	Size	Inner Qty	Outer Qty	List Price
OX-P083524	5060242335235	24" / 610mm	2	6	\$48.33



PRO SCUTCH COMBS HOLDERS

FEATURES

- For detachable stone dressing combs
- Heavy duty high carbon steel
- Hardened & tempered for durability

Product Code	Barcode	Size	Inner Qty	Outer Qty	List Price
OX-P090310	9341231020759	200 x 25mm / 8 x 1"	4	16	\$49.30
OX-P090315	9341231020766	200 x 38mm / 8 x 1 1/2"	4	16	\$58.75

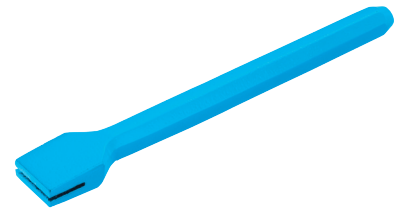

PRO SCUTCH COMBS

FEATURES

- To fit into a scutch comb holder
- For preparation of surface prior to re-rendering
- Three different sizes – 25, 38 & 50mm

4-PACK

Product Code	Barcode	Size	Inner Qty	Outer Qty	List Price
OX-P080725	9341231010712	25mm	4	16	\$13.99
OX-P080738	9341231010729	38mm	4	16	\$15.09
OX-P080750	9341231010736	50mm	4	16	\$23.36

BULK PACK - 100 PIECES

Product Code	Barcode	Size	Inner Qty	Outer Qty	List Price
OX-P080725B	9341231022333	25mm	N/A	4	\$179.34
OX-P080738B	9341231022340	38mm	N/A	4	\$285.78
OX-P080750B	9341231022357	50mm	N/A	4	\$354.95





Plumbing & Electrical Tools

The performance, service life and ergonomics of our tools are guided by the need to meet the high expectations of professional users.

That is why we use particularly high-quality materials and modern production technology.



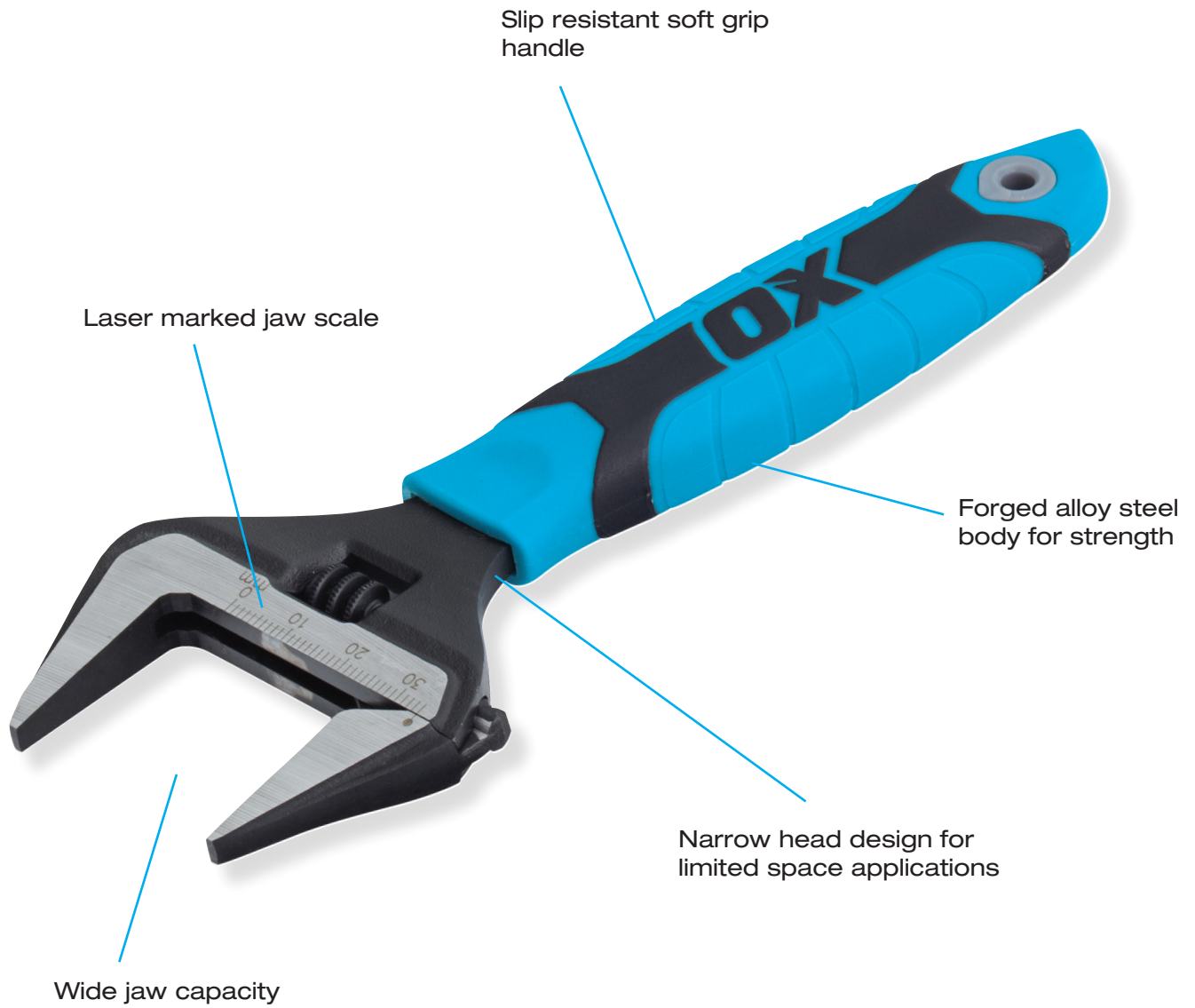



PRO ULTRA-WIDE JAW ADJUSTABLE WRENCH



FEATURES

- Ultra wide jaw opening
- Very slim head for access into tight spaces
- Precision hardened for durability
- Soft grip handle
- Measurement scale on jaw

Product Code	Barcode	Size	Order Qty	Box Qty	List Price
OX-P324606	5060242337512	6" / 152mm	N/A	10	\$33.08
OX-P324608	5060242337529	8" / 200mm	N/A	5	\$40.33
OX-P324610	5060242337536	10" / 250mm	N/A	5	\$51.08
OX-P324612	5060242337543	12" / 300mm	N/A	5	\$70.95

PRO ADJUSTABLE WRENCH



FEATURES

- Narrow head design for limited space applications
- Laser marked jaw scale
- Soft grip handle
- Forged alloy-steel body for strength
- Wide jaw capacity

Product Code	Barcode	Size	Inner Qty	Outer Qty	List Price
OX-P324506	5060242335709	6" / 152mm	4	12	\$16.89
OX-P324508	5060242335716	8" / 200mm	4	12	\$21.98
OX-P324510	5060242335723	10" / 250mm	4	12	\$25.39
OX-P324512	5060242335730	12" / 300mm	4	12	\$36.08

PRO LONG NOSE PLIERS



FEATURES

- Tough chrome vanadium steel
- Drop forged
- Hardened and tempered jaws
- Ergonomic grip handles with slip guards

Product Code	Barcode	Size	Inner Qty	Outer Qty	List Price
OX-P321620	5060242337703	8" / 200mm	4	12	\$30.36

PRO DIAGONAL SIDE CUTTING PLIERS



FEATURES

- Tough chrome vanadium steel
- Drop forged
- Hardened and tempered jaws
- Ergonomic grip handles with slip guards

Product Code	Barcode	Size	Inner Qty	Outer Qty	List Price
OX-P321416	5060242337680	6" / 160mm	4	12	\$25.81



PRO COMBINATION PLIERS

FEATURES

- Tough chrome vanadium steel
- Drop forged
- Hardened and tempered jaws
- Ergonomic grip handles with slip guards

Product Code	Barcode	Size	Inner Qty	Outer Qty	List Price
OX-P321318	5060242337673	7½" / 190mm	4	12	\$28.30



PRO GROOVE JOINT PLIERS

FEATURES

- Tough chrome vanadium steel
- 5 step adjustment
- Hardened and tempered jaws
- Ergonomic grip handles with slip guards

Product Code	Barcode	Size	Inner Qty	Outer Qty	List Price
OX-P325825	5060328040732	10" / 250mm	4	12	\$33.94



PRO AUTOMATIC WATERPUMP PLIERS

FEATURES

- Automatic waterpump pliers for fast one hand size adjustment
- Tough chrome vanadium steel
- Double dipped handle for comfort

Product Code	Barcode	Size	Order Qty	Box Qty	List Price
OX-P326010	5060359914521	250mm / 10"	1	10	\$36.58



PRO ADJUSTABLE BASIN WRENCH

FEATURES

- Telescopic basin nut wrench
- Reversible Jaw for easy access
- 4 adjustment sizes
- 10 to 32mm Jaw Capacity

Product Code	Barcode	Size	Order Qty	Box Qty	List Price
OX-P448401	5060359914620	10 - 32mm	1	15	\$64.92





Site Tools & Accessories



OX offers a premium range of site tools to cater for every need.

Our extensive range of shovels are manufactured to withstand the heat, the cold and the building site. Don't settle for something inferior.

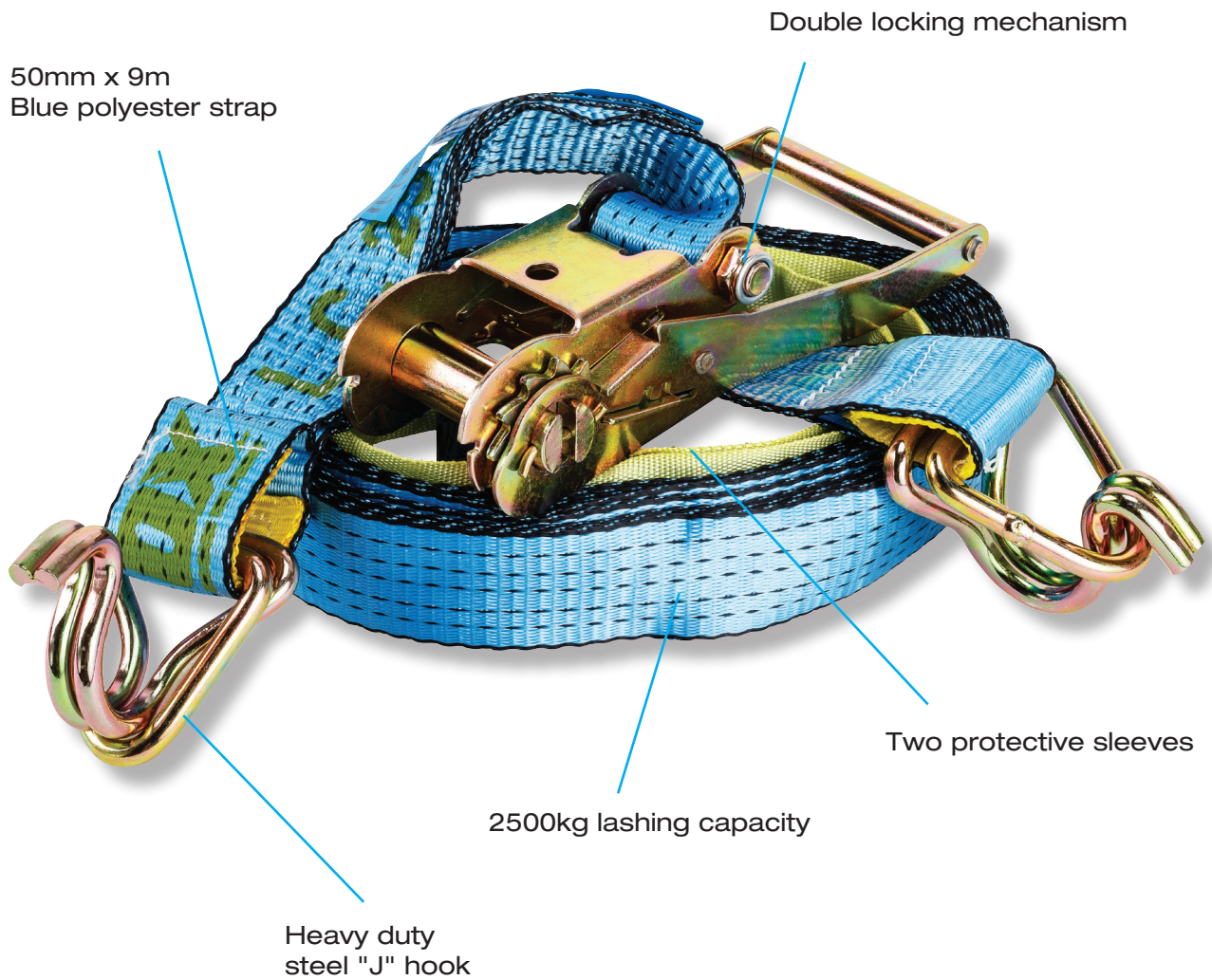



TRADE SPOT MARKING PAINT - 12 PACK



12
BOX

FEATURES

- 12 Pack
- Lead free
- Professional quality hi-visibility colours
- 350g aerosole can
- Ideal for marking out roadworks, building sites, grass and sporting areas
- Use on asphalt, dirt, concrete & timber
- Unique trigger cap for easy, safe, inverted marking

Product Code	Barcode	Size / Colour	List Price
OX-T022501	9341231000553	350g / Blue	\$94.22
OX-T022502	9341231000560	350g / Fluro Green	\$94.22
OX-T022503	9341231000577	350g / Fluro Orange	\$94.22
OX-T022504	9341231000584	350g / Fluro Pink	\$94.22
OX-T022505	9341231000591	350g / Fluro Red	\$94.22
OX-T022506	9341231000607	350g / White	\$94.22
OX-T022507	9341231000614	350g / Fluro Yellow	\$94.22

PRO RATCHET TIE DOWN - 4 PACK



FEATURES

- 25mm X 4m polyester webbing
- Vinyl coated 'S' hooks at each end
- Lashing capacity 500Kg
- Pack of four straps
- Complies with AS/NZS

Product Code	Barcode	Load Rating	Inner Qty	Outer Qty	List Price
OX-P200904	9341231024139	500kg	N/A	5	\$29.97

PRO RATCHET TIE DOWN - 2 PACK



FEATURES

- 35mm X 6m polyester webbing
- Lashing capacity 1250kg
- Pack of two straps
- Complies with AS/NZS

Product Code	Barcode	Load Rating	Inner Qty	Outer Qty	List Price
OX-P201006	9341231025921	1250kg	N/A	5	\$29.97

PRO RATCHET TIE DOWN - SINGLE



FEATURES

- 50mm x 9m blue polyester strap
- Double locking mechanism
- 2 protective sleeves
- Lashing capacity 2500kg
- Complies with AS/NZS

Product Code	Barcode	Load Rating	Inner Qty	Outer Qty	List Price
OX-P201109	9341231011078	2500kg	N/A	5	\$28.54



PRO SAW HORSE - 2 PACK

FEATURES

- Durable and sturdy saw horse set
- Solid timber benchtop 800mm length
- 200kg load capacity
- 750 mm High
- Lockable legs
- Locking pin

Product Code	Barcode	Quantity	Inner Qty	Outer Qty	List Price
OX-P335675	9341231034466	2pcs set	N/A	10	\$195.76

New Design



PRO SINGLE STEP UPS / PRO DOUBLE STEP UPS

FEATURES

- Light weight
- Sturdy Construction
- Easy Assembly required

Product Code	Barcode	Inner Qty	Outer Qty	List Price
OX-P335701	9341231014642	1	1	\$74.80
OX-P335702	9341231014659	1	1	\$132.00

New



PRO CAULKING GUN

FEATURES

- Skeleton frame
- 6mm hex rod with ladder hang hook
- Quick release lever

Product Code	Barcode	Size	Inner Qty	Outer Qty	List Price
OX-P040109	9341231011719	400ml	6	24	\$16.21



TRADE TUBULAR SEALANT GUN

FEATURES

- Heavy duty construction
- Robust operation
- Aluminium tube

Product Code	Barcode	Size	Inner Qty	Outer Qty	List Price
OX-T040215	9341231025815	15" / 380mm	4	12	\$33.94



PRO TUBULAR SEALANT GUN

FEATURES

- Quick release lever
- Suits 600mm bulk cartridges
- Aluminium tube

Product Code	Barcode	Size	Inner Qty	Outer Qty	List Price
OX-P040211	9341231035593	11" / 280mm	4	12	\$59.35
OX-P040215	9341231007361	15" / 380mm	4	12	\$62.24





PRO SEALANT GUN REPLACEMENT PARTS

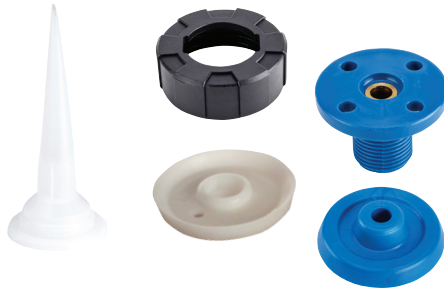

FEATURES

- Genuine OX sealant gun parts
- Suits OX pro sealant gun

Product Code	Barcode	Part	Inner Qty	Outer Qty	List Price
OX-P049801	9341231011719	Nozzle - 6PK	6	24	\$8.58
OX-P049801B	9341231013492	Nozzle - 50PK	N/A	4	\$64.87
OX-P049802	9341231011757	Plunger Cap	N/A	12	\$7.81
OX-P049803	9341231013508	Threaded Collar	N/A	12	\$8.75
OX-P049804	9341231013515	Plunger Slide Sleeve	N/A	12	\$9.19

TRADE FLOOR SCRAPER

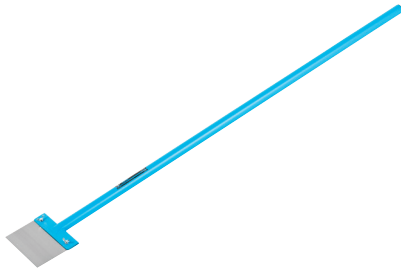

FEATURES

- All steel construction & spring steel blade

Product Code	Barcode	Blade Size	Inner Qty	Outer Qty	List Price
OX-T050508	9341231011856	8" / 200mm	N/A	3	\$46.85
OX-T050512	9341231011863	12" / 300mm	N/A	3	\$55.68
OX-T050514	9341231033742	14" / 356mm	N/A	3	\$63.36
OX-T050520	9341231033759	20" / 500mm	N/A	3	\$70.70



- Replacement spring steel blade

Product Code	Barcode	Suits	Inner Qty	Outer Qty	List Price
OX-T059408	9341231033766	OX-T050508	4	12	\$15.92
OX-T059412	9341231033733	OX-T050512	4	12	\$18.21
OX-T059414	9341231033780	OX-T050514	4	12	\$22.96
OX-T059420	9341231033797	OX-T050520	4	12	\$25.91

PRO ALL STEEL FLOOR SCRAPER

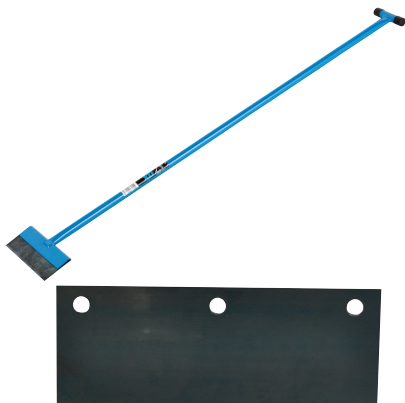

FEATURES

- All steel construction
- Spring steel blade
- T-Grip handle

Product Code	Barcode	Size	Inner Qty	Outer Qty	List Price
OX-P050208	9341231001765	8" / 200mm	N/A	3	\$45.57

- Replacement spring steel blade

Product Code	Barcode	Suits	Inner Qty	Outer Qty	List Price
OX-P059808	9341231001789	OX-P050208	4	18	\$13.53



PRO FLOOR SCRAPER

FEATURES

- All steel head with hardwood handle
- Braced for extra strength
- Spring steel blade

Product Code	Barcode	Blade Width	Inner Qty	Outer Qty	List Price
OX-P050314	9341231020278	14" / 356mm	N/A	3	\$69.16

- Replacement spring steel blade

Product Code	Barcode	Suits	Inner Qty	Outer Qty	List Price
OX-P059714	9341231021954	OX-P050314	4	18	\$25.19



PRO HEAVY DUTY FLOOR SCRAPER

FEATURES

- All steel construction
- Spring steel blade
- Trapezoid blade
- T-Grip handle

Product Code	Barcode	Size	Inner Qty	Outer Qty	List Price
OX-P050408	9341231021473	8" / 200mm	N/A	3	\$78.10

- Replacement spring steel trapezoid blade

Product Code	Barcode	Suits	Inner Qty	Outer Qty	List Price
OX-P059608	9341231021480	OX-P050408	4	18	\$16.73



PRO SAFETY SCRAPER

FEATURES

- Excellent for cleaning Tiles, Glass and other smooth surfaces
- Quick change blade

Product Code	Barcode	Size	Inner Qty	Outer Qty	List Price
OX-P050609	9341231034725	3 1/2" / 90mm	4	12	\$11.92

- Replacement safety scraper blade

Product Code	Barcode	Suits	Inner Qty	Outer Qty	List Price
OX-P050909	9341231021480	OX-P050609	24	240	\$5.03





TRADE SQUARE MOUTH SHOVEL



FEATURES

- 'D' grip handle
- All steel, pressed and welded construction
- High visibility blue powder coated
- Head size: 250 x 300MM

Product Code	Barcode	Length	Inner Qty	Outer Qty	List Price
OX-T280107	9341231000089	1040mm	N/A	6	\$15.86
OX-T280109	9341231000072	1200mm	N/A	6	\$16.80

TRADE SQUARE MOUTH SHOVEL



FEATURES

- Long handle – rubber grip
- All steel, pressed and welded construction
- High visibility blue powder coated
- Head size: 250 x 300MM

Product Code	Barcode	Length	Inner Qty	Outer Qty	List Price
OX-T280212	9341231000096	1220mm	N/A	6	\$22.06

PRO PLASTIC BUCKET



FEATURES

- Made in Spain
- Safety metal handle
- High grade moulded rubber

Product Code	Barcode	Size	Inner Qty	Outer Qty	List Price
OX-P110610	9341231035715	10L	N/A	10	\$25.35

PRO MASONRY BUCKET



FEATURES

- Flexible HDPE material
- Non-marking smooth base
- Safety metal handle

Product Code	Barcode	Size	Inner Qty	Outer Qty	List Price
OX-P110215	9341231007354	15L	N/A	10	\$24.80



PRO RUBBER BUCKET WITH POURING LIP

FEATURES

- Made in Spain
- Reinforced profile
- High grade moulded rubber

Product Code	Barcode	Size	Inner Qty	Outer Qty	List Price
OX-P110615	9341231034473	15L	N/A	10	\$38.20



PRO MASONRY BUCKET

FEATURES

- Made in Italy
- Polythene construction
- Enameld Steel Handle
- 25L for mixing an entire bag in one go

Product Code	Barcode	Size	Inner Qty	Outer Qty	List Price
OX-P110425	9341231031564	25L	N/A	10	\$36.00



PRO HEAVY DUTY RUBBER BUCKET

FEATURES

- Made in Spain
- Reinforced profile
- High grade moulded rubber

Product Code	Barcode	Size	Inner Qty	Outer Qty	List Price
OX-P110640	9341231034435	40L	N/A	10	\$27.45



TRADE TRIGGER SPRAYER

FEATURES

- Twist lock pump handle
- Smooth operating trigger
- Ergonomic handles for comfort & control
- Heavy duty plastic

Product Code	Barcode	Capacity ml.	Inner Qty	Outer Qty	List Price
OX-T042005	9341231032240	500ml	6	12	\$9.08
OX-T042010	9341231032257	1000ml	6	12	\$9.08



PRO EXTENSION LEAD

FEATURES

- Super duty 15A cable
- Industrial plug and socket
- LED 'power on' light
- 10A plug

Product Code	Barcode	Length	Inner Qty	Outer Qty	List Price
OX-P311710	9341231029431	10M	N/A	4	\$32.04
OX-P311720	9341231029448	20M	N/A	4	\$51.90
OX-P311730	9341231029455	30M	N/A	4	\$74.19





Tool Storage

Like you, we take our work seriously and believe that every detail has to be designed and manufactured with great care to ensure our products really work and also look good.

If you are looking for hardwearing, functional tool storage solutions to cope with the most extreme work conditions – OX has what you need!





Riveted pocket

Roller buckle

Heavy duty oil tanned leather



Double stitching

Multi size pockets & compartments



PRO ROUND TOP TOOL BAG

FEATURES

- Extremely tough construction for ultimate durability
- Injected polypropylene hard base
- Strong rubber grip handle and padded shoulder strap
- Multiple use tool compartments
- Waterproof base moulded to fabric

Product Code	Barcode	Size	Inner Qty	Outer Qty	List Price
OX-P261747	5060242333767	470 x 280 x 350mm	N/A	2	\$136.07



PRO SUPER OPEN MOUTH TOOL BAG

FEATURES

- Extremely tough construction for ultimate durability
- Injected polypropylene hard base
- Strong rubber grip handle and padded shoulder strap
- Multiple use tool compartments
- Waterproof base moulded to fabric

Product Code	Barcode	Size	Inner Qty	Outer Qty	List Price
OX-P261645	5060242333750	450 x 310 x 260mm	N/A	2	\$126.32

New



PRO TOTE BAG

FEATURES

- Extremely tough construction for ultimate durability
- Injected polypropylene hard base
- Waterproof base moulded to fabric
- Heavy-duty steel handle with rubber grip
- Open structure for quick and easy tool access
- Multiple use tool compartments

Product Code	Barcode	Size	Inner Qty	Outer Qty	List Price
OX-P262618	5060242338618	18"	N/A	2	\$98.18



PRO TOOL BAG

FEATURES

- High quality durable layer nylon
- Water resistant
- Rubber feet-pads
- Internal & external pockets - 18 in total

Product Code	Barcode	Size	Inner Qty	Outer Qty	List Price
OX-P260118	9341231022845	500 x 230 x 300mm	N/A	10	\$53.63



PRO LEATHER HAMMER HOLDER

FEATURES

- Fixed type
- Heavy duty leather
- Wide belt slots
- Rust proof fixed metal hammer hanger



Product Code	Barcode	Inner Qty	Outer Qty	List Price
OX-P260501	9341231010590	N/A	6	\$5.61

PRO LEATHER HAMMER HOLDER

FEATURES

- Swivel type
- Heavy duty leather
- Wide belt slots
- Rust proof fixed metal hammer hanger



Product Code	Barcode	Inner Qty	Outer Qty	List Price
OX-P260502	9341231010606	N/A	6	\$5.61

PRO LEATHER TAPE MEASURE HOLDER

FEATURES

- Fits most model of tapes
- Two finger push up pocket
- Close with strap & snap
- Wide belt slots



Product Code	Barcode	Inner Qty	Outer Qty	List Price
OX-P260503	9341231010613	N/A	6	\$11.50



PRO LEATHER CHISEL HOLDER



FEATURES

- Heavy duty leather
- Wide belt slots
- Designed to fit most chisels, rules and knives

Product Code	Barcode	Inner Qty	Outer Qty	List Price
OX-P260504	93412310106204	N/A	6	\$10.24

PRO LEATHER CORDLESS DRILL HOLDER



FEATURES

- Angled type
- Fits medium to large size cordless drill
- 3 small bit pockets, close with strap & snap wide belt slots

Product Code	Barcode	Inner Qty	Outer Qty	List Price
OX-P260505	9341231010637	N/A	6	\$22.28

PRO LEATHER TOOL POUCH WITH BELT



FEATURES

- 2 large inverted pockets, 2 medium, 6 small pockets
- Heavy duty leather belt with roller buckle
- A leather type pocket, 2 metal hammer hangers
- Riveted for added strength

Product Code	Barcode	Size	Inner Qty	Outer Qty	List Price
OX-P260701	9341231010545	36"	N/A	6	\$102.81
OX-P260702	9341231010552	40"	N/A	6	\$102.81

PRO LEATHER CARPENTERS POUCH



FEATURES

- Heavy duty oil tanned leather
- A metal tape holder, 3 small tool pockets & 2 leather hammer loops
- One large main pocket with inner level pockets, 2 front nail pockets
- Riveted & wide belt slots

Product Code	Barcode	Size	Inner Qty	Outer Qty	List Price
OX-P260703	9341231010569	-	N/A	6	\$68.26



PRO LEATHER FRAMERS POUCH

FEATURES

- Designed for multi tool storage
- 1 side long pockets
- Wide belt slots
- 4 tier design for easy separation of tools & fasteners



Product Code	Barcode	Inner Qty	Outer Qty	List Price
OX-P260704	9341231010576	N/A	6	\$70.27

PRO LEATHER NAIL POUCH

FEATURES

- 1 large main pocket
- 1 metal hammer hanger
- 1 belt level inner pocket
- 2 front nail tool pockets
- Riveted & belt slot



Product Code	Barcode	Inner Qty	Outer Qty	List Price
OX-P260705	9341231010583	N/A	6	\$74.47

PRO LEATHER TOOL BELT

FEATURES

- High quality leather
- Heavy duty oil tanned leather
- Double stitching
- Metal roller buckle



Product Code	Barcode	Size	Inner Qty	Outer Qty	List Price
OX-P260736	9341231010644	36" / 900mm	N/A	6	\$25.81
OX-P260740	9341231010651	40" / 1000mm	N/A	6	\$25.81



Safety Equipment

If you are looking for hardwearing, functional Personal Protection Equipment to cope with the most extreme work conditions – OX has what you need.

Like you, we take our work seriously and believe that every detail has to be designed and manufactured with great care to ensure our products really work and also look good.

All OX safety products meet 'AS/NZ standards' where applicable.

Once you have tried OX Safety you will never leave it!





Latex rubber glove with ripple palm for additional grip

Knitted wrist helps exclude debris

Complies with Australian safety standards

Jersey lined for comfort



Safety Equipment

SAFETY GLASSES – STANDARD CLEAR



FEATURES

- Stylish design with adjustable nose bridge for comfort
- Medium impact anti-scratch, anti-fog lens
- 99.9% UV protection for outdoor wear
- Complies with AS/NZS1337

Product Code	Barcode	Colour	Inner Qty	Outer Qty	List Price
OX-S240210	9341231011320	Clear	12	144	\$9.68

SAFETY GLASSES – STANDARD SMOKE



FEATURES

- Stylish design with adjustable nose bridge for comfort
- Medium impact anti-scratch, anti-fog lens
- 99.9% UV protection for outdoor wear
- Complies with AS/NZS1337

Product Code	Barcode	Colour	Inner Qty	Outer Qty	List Price
OX-S240220	9341231011337	Smoke	12	144	\$9.68

SAFETY GLASSES – STANDARD BLUE MIRRORED



FEATURES

- Stylish design with adjustable nose bridge for comfort
- Medium impact anti-scratch, anti-fog lens
- 99.9% UV protection for outdoor wear
- Complies with AS/NZS1337

Product Code	Barcode	Colour	Inner Qty	Outer Qty	List Price
OX-S240230	9341231011344	Blue mirrored	12	144	\$9.68

SAFETY DISPOSABLE EAR PLUGS – UN-CORDED



FEATURES

- Disposable PU foam
- Hearing protection for noise levels up to 110 dB(A)
- Complies with AS/NZS1270:2002
- Packed in pairs (Individual poly bags)

Product Code	Barcode	Qty Per Pack	Inner Qty	Outer Qty	List Price
OX-S240402	5060242330766	200	N/A	4	\$65.78



SAFETY DISPOSABLE EAR PLUGS – CORDED

FEATURES

- Disposable PU foam
- Hearing protection for noise levels up to 110 dB(A)
- Complies with AS/NZS1270:2002
- Packed in pairs (Individual poly bags)



Product Code	Barcode	Qty Per Pack	Inner Qty	Outer Qty	List Price
OX-S240702	5060242330773	200	N/A	4	\$65.78

SAFETY DISPOSABLE MASKS – NON TOXIC

FEATURES

- Non toxic dust mask
- Aluminium nosepiece can be moulded to fit
- Lightweight and comfortable for extended wear
- Ideal for protection against large dust particles



Product Code	Barcode	Qty Per Pack	Inner Qty	Outer Qty	List Price
OX-S242110	9341231013881	10	6	24	\$3.51
OX-S242150	9341231024214	50	N/A	12	\$9.74

SAFETY DISPOSABLE MASKS – P1 DUST MASK

FEATURES

- P1 rating for protection against mechanically generated particles
- Unique design for wide variety of face profiles
- Dual straps for firm and comfortable fit
- Complies with AS/NZS1716



Product Code	Barcode	Qty Per Pack	Inner Qty	Outer Qty	List Price
OX-S240605	9341231013867	5	6	24	\$8.60
OX-S240620	9341231024184	20	N/A	12	\$29.13

SAFETY DISPOSABLE MASKS – P2 DUST MASK

FEATURES

- P2 rating for protection against mechanically and thermally generated particles
- Unique design for wide variety of face profiles
- Dual straps for firm and comfortable fit
- Complies with AS/NZS1716



Product Code	Barcode	Qty Per Pack	Inner Qty	Outer Qty	List Price
OX-S240810	9341231000157	20	N/A	12	\$31.13



SAFETY DISPOSABLE MASKS – P2V DUST MASK



FEATURES

- P2 rating for protection against mechanically and thermally generated particles
- Exhalation valve for increased air flow
- Dual straps for firm and comfortable fit
- Complies with AS/NZS1716

Product Code	Barcode	Qty Per Pack	Inner Qty	Outer Qty	List Price
OX-S240903	9341231013874	3	6	24	\$9.45
OX-S240910	9341231000164	12	N/A	12	\$30.81

SAFETY DISPOSABLE MASKS – P2V DUST MASK



FEATURES

- P2 rating for protection against mechanically and thermally generated particles
- Exhalation valve for increased air flow
- Dual straps for firm and comfortable fit
- Complies with AS/NZS1716
- Carbon filter

Product Code	Barcode	Qty Per Pack	Inner Qty	Outer Qty	List Price
OX-S242212	9341231030888	12	N/A	12	\$32.01

SAFETY FLAT FOLD MASKS – P1 FLAT MASKS



FEATURES

- P1 rating for protection against mechanically generated particles
- Dual straps for firm and comfortable fit
- Unique design for easy storage
- Complies with AS/NZS1716

Product Code	Barcode	Qty Per Pack	Inner Qty	Outer Qty	List Price
OX-S246120	9341231024191	20	N/A	12	\$26.07

SAFETY FLAT FOLD MASKS – P2V FLAT MASKS



FEATURES

- P2 rating for protection against mechanically and thermally generated particles
- Dual straps for firm and comfortable fit
- Exhalation valve for increased air flow
- Complies with AS/NZS1716

Product Code	Barcode	Qty Per Pack	Inner Qty	Outer Qty	List Price
OX-S246412	9341231024207	12	N/A	12	\$31.83



SAFETY LATEX GLOVES - POLYESTER LINED

FEATURES

- Gauge polyester, knit wrist, latex crinkle coated palm
- Made of a high-performance latex, providing outstanding combination of strength and chemical resistance
- Offers protection against snags, punctures, abrasions, and cuts
- Minimum perspiration
- Comply with CE standard regulations, meet with EN420 and EN388



EN388



EN420

Product Code	Barcode	Size	Inner Qty	Outer Qty	List Price
OX-S481310	9341231037610	10	12	144	\$3.65

SAFETY NITRILE GLOVES - NYLON LINED

FEATURES

- 15 Gauge nylon, knit wrist, nitrile foam coated palm
- Made of a high-performance nitrile, providing outstanding combination of strength and chemical resistance
- Offers excellent dry grip by moving oils and liquids away from the glove surface
- Excellent breathability
- Comply with CE standard regulations, meet with EN420 and EN388



EN388



EN420

Product Code	Barcode	Size	Inner Qty	Outer Qty	List Price
OX-S481410	9341231037627	10	12	144	\$4.00

SAFETY PU SYNTHETIC GLOVES

FEATURES

- Breathable with nylon liner
- Polyurethane (PU) coated palm
- Lightweight and comfortable
- Ideal for small parts handling
- Conforms to EN388 standards



EN388



4131

Product Code	Barcode	Size	Inner Qty	Outer Qty	List Price
OX-S241109	5060135479664	9	12	48	\$4.94
OX-S241110	5060135479671	10	12	48	\$4.94



SAFETY STANDARD KNEEPADS – DOUBLE STRAP



FEATURES

- Durable rubber face with foam 'liner'
- Quick release 'hook and loop' fastening
- One size fits all
- Ideal for professional trade, D.I.Y or gardening

Product Code	Barcode	Size	Inner Qty	Outer Qty	List Price
OX-S240102	9341231011740	One Size Fits All	4	8	\$37.84

SAFETY GEL KNEEPADS – PREMIUM



FEATURES

- Anti compression air injected gel
- Foam core gives maximum cushioning
- Perforated neoprene lining keeps away moisture

Product Code	Barcode	Size	Inner Qty	Outer Qty	List Price
OX-S242006	9341231001178	One Size Fits All	N/A	12	\$58.59

SAFETY STANDARD GUMBOOTS



FEATURES

- Oil, acid and abrasion resistant
- Tradesman quality with steel safety toe
- Reinforced ankle and shin for greater protection
- Sole channelling for improved liquid disposal and slip resistance

Product Code	Barcode	Size	Inner Qty	Outer Qty	List Price
OX-S242407	9341231004735	7	N/A	5	\$52.68
OX-S242408	9341231004742	8	N/A	5	\$52.68
OX-S242409	9341231004759	9	N/A	5	\$52.68
OX-S242410	9341231004766	10	N/A	5	\$52.68
OX-S242411	9341231004773	11	N/A	5	\$52.68
OX-S242412	9341231004780	12	N/A	5	\$52.68
OX-S242413	9341231004797	13	N/A	5	\$52.68





SAFETY BARRIER TAPE - 20 PACK

FEATURES

- 20 pack
- Heavy duty plastic
- Single sided print
- Yellow with black printed CAUTION

Product Code	Barcode	Size	List Price
OX-S243310	9341231025853	75mm x 100m	\$172.00



SAFETY BARRIER TAPE - 20 PACK

FEATURES

- 20 pack
- Heavy duty plastic
- Single sided print
- Red & white striped printed DANGER

Product Code	Barcode	Size	List Price
OX-S243410	9341231029028	75mm x 100m	\$172.00



SAFETY BARRIER TAPE - 20 PACK

FEATURES

- 20 pack
- Heavy duty plastic
- Single sided print
- Red & white striped

Product Code	Barcode	Size	List Price
OX-S243110	9341231011962	75mm x 100m	\$172.00



SAFETY BARRIER TAPE - 20 PACK

FEATURES

- 20 pack
- Heavy duty plastic
- Double sided print
- Red & white striped

Product Code	Barcode	Size	List Price
OX-S243210	9341231011979	75mm x 100m	\$196.00



SAFETY BARRIER TAPE - 20 PACK

FEATURES

- 20 pack
- Heavy duty plastic
- Single sided print
- Yellow & black striped

Product Code	Barcode	Size	List Price
OX-S243010	9341231029011	75mm x 100m	\$172.00





Indent Container Program

Available in FCL only

OX Group has the most comprehensive ladder and access range in the industry today with a host of cutting edge features from hard wearing ladder feet and titan tough rivets to ensure durability, to non-clogging hinges that allow dirt and plaster to fall away.

OX ladders have been designed and manufactured to exceed industry standards, with optimum safety an absolute priority, guaranteeing dependable support when and where you need it.





ADVANTAGES OF CONTAINER DEALS

- Increase your margin up to 20%
- Opportunity for private labelling - promote your own brand
- Providing you regional exclusivity on FCL products
- Reduce damage by domestic transport

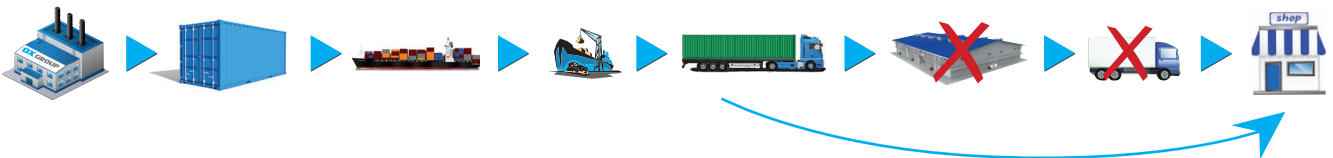

Lead Times 8-12 weeks!



Indent Container Program

TRADE DOUBLE SIDED STEP LADDER 120KG



FEATURES

- Hard-wearing ladder feet - the hardest-wearing part of a ladder
- Titan tough rivets for maximum durability
- Non-clogging hinge
- Extra large head rivets
- Internal side stay - avoids damage, stronger
- Will not seize and collapse

Product code	Barcode	Size	Height	Weight	List Price
OX-T330902	9341231026058	2 Step	0.6m	5kg	FCL
OX-T330903	9341231026065	3 Step	0.9m	6kg	FCL
OX-T330904	9341231026072	4 Step	1.2m	7kg	FCL
OX-T330905	9341231026089	5 Step	1.5m	8kg	FCL
OX-T330906	9341231026096	6 Step	1.8m	9kg	FCL
OX-T330907	9341231026102	7 Step	2.1m	10kg	FCL
OX-T330908	9341231026119	8 Step	2.4m	11kg	FCL

TRADE DOUBLE SIDED STEP LADDER 150KG



FEATURES

- Hard-wearing ladder feet - the hardest-wearing part of a ladder
- Non-clogging hinge
- Will not seize and collapse
- Extra large head rivets
- Titan tough rivets for maximum durability
- Internal side stay - avoids damage

Product code	Barcode	Size	Height	Weight	List Price
OX-T331202	9341231026126	2 Step	0.6m	6kg	FCL
OX-T331203	9341231013188	3 Step	0.9m	7kg	FCL
OX-T331204	9341231013195	4 Step	1.2m	8kg	FCL
OX-T331205	9341231026133	5 Step	1.5m	10kg	FCL
OX-T331206	9341231013201	6 Step	1.8m	11kg	FCL
OX-T331207	9341231013218	7 Step	2.1m	12kg	FCL
OX-T331208	9341231013225	8 Step	2.4m	13kg	FCL

TRADE BIG TOP DOUBLE SIDED STEP LADDER 150KG



Extra Wide Double Sided Ladder for Greater Versatility

FEATURES

- Durable anti-slip feet - the highest wearing part of a ladder
- Heavy duty aluminium construction
- Extra large head rivets - titan tough for maximum durability
- Internal side stay - avoids damage, stronger

Product code	Barcode	Size	Height	Weight	List Price
OX-T331703	9341231026188	3 Step	0.9m	5.5kg	FCL
OX-T331704	9341231026195	4 Step	1.2m	6.5kg	FCL



TRADE DUAL PURPOSE STEP EXTENSION LADDER 120KG

FEATURES

- Hard-wearing feet - the highest wearing part of a ladder
- Cross braced side stay - much more stable
- Trapezoidal back steps - comfortable to use in either 'A' shape or folded out
- Extra large head rivets - titan tough, maximum durability
- Secure locking latch - guards against accidental dislodgement

Product code	Barcode	Size	Height	Weight	List Price
OX-T330704	9341231026201	4 Step	1.2m - 2.1m	8kg	FCL
OX-T330706	9341231026218	6 Step	1.8m - 3.3m	9kg	FCL
OX-T330707	9341231026225	7 Step	2.1m - 3.9m	10kg	FCL
OX-T330708	9341231026232	8 Step	2.4m - 4.5m	11kg	FCL



TRADE DUAL PURPOSE STEP EXTENSION LADDER 150KG

FEATURES

- Hard-wearing feet - the highest wearing part of a ladder
- Cross braced side stay - much more stable
- Trapezoidal back steps - comfortable to use in either 'A' shape or folded out
- Extra large head rivets - titan tough, maximum durability
- Secure locking latch - guards against accidental dislodgement

Product code	Barcode	Size	Height	Weight	List Price
OX-T331004	9341231026249	4 Step	1.2m - 2.1m	8kg	FCL
OX-T331006	9341231026256	6 Step	1.8m - 3.3m	9kg	FCL
OX-T331007	9341231026263	7 Step	2.1m - 3.9m	10kg	FCL
OX-T331008	9341231026270	8 Step	2.4m - 4.5m	11kg	FCL



TRADE TELESCOPIC MULTI PURPOSE LADDER

Extendable Legs - for Extra Height & Stairs

FEATURES

- 150kg rating
- Easily seen hinge lock - it's obvious when it's secure
- Heavy duty feet braces - greater stability
- Easily operated height lock - simple pull out and release
- All-in-One - five different settings for every application

Product code	Barcode	Description	Height	Weight	List Price
OX-T332303	9341231026287	All-in-one telescopic	0.9m - 3.3m	12kg	FCL
OX-T332304	9341231026294	All-in-one telescopic	1.2m - 4.5m	15.5kg	FCL
OX-T332305	9341231026300	All-in-one telescopic	1.5m - 5.7m	18kg	FCL





TRADE PLATFORM STEP LADDER 150KG

New Design



Large Anti-Skid Work Platform with Raised Edges

FEATURES

- Keeps feet inside platform for greater safety and comfort
- One piece smooth operation - simply folds out giving a well braced platform and folds flat for storage
- Welded back leg - greater rigidity, durability and safety
- Optional bolt on handrail and gate

Product code	Barcode	Description	Height	Weight	List Price
OX-T331102	9341231026317	2 Step	0.6m	8kg	FCL
OX-T331103	9341231026324	3 Step	0.9m	9kg	FCL
OX-T331104	9341231026331	4 Step	1.2m	10kg	FCL
OX-T331105	9341231026348	5 Step	1.5m	11.5kg	FCL
OX-T331106	9341231026355	6 Step	1.8m	13kg	FCL
OX-T331107	9341231026362	7 Step	2.1m	15kg	FCL
OX-T331108	9341231026379	8 Step	2.4m	17kg	FCL
OX-T331109	9341231031250	9 Step	2.7m	19kg	FCL
OX-T335001	9341231027314	Handrail & Safety Gate Set			FCL
OX-T335101	9341231031267	Handy Bucket*			FCL
OX-T335201	9341231031274	Castor Set			FCL

* Only suitable with Handrail and Safety Gate Set

TRADE EXTENSION LADDERS 120KG

Rope Operated

FEATURES

- Side mounted rope - avoids tripping hazard
- Triple pulley - three times easier to lift
- Auto engaging height lock - ensuring your safety
- Heavy duty feet - resists wear
- 'D' shape rungs - for comfortable standing



Product code	Barcode	Size	Height	Weight	List Price
OX-T331309	9341231026393	9 Step	2.9m - 4.7m	13.5kg	FCL
OX-T331310	9341231031397	10 step	3.2m - 5.3m	14.25kg	FCL
OX-T331311	9341231026409	11 Step	3.45m - 6.0m	15kg	FCL
OX-T331313	9341231026416	13 Step	4.1m - 7.2m	17.5kg	FCL



TRADE EXTENSION LADDERS 150KG

Rope Operated

FEATURES

- Side mounted rope - avoids tripping hazard
- Triple pulley - three times easier to lift
- Auto engaging height lock - ensuring your safety
- Heavy duty feet - resists wear
- 'D' shape rungs - for comfortable standing

Product code	Barcode	Size	Height	Weight	List Price
OX-T331409	9341231026423	9 Step	2.9m - 4.7m	13.5kg	FCL
OX-T331410	9341231034046	10 Step	3.2m - 5.3m	15kg	FCL
OX-T331411	9341231026430	11 Step	3.45m - 6.0m	16kg	FCL
OX-T331412	9341231034053	12 Step	3.8m - 6.6m	17 kg	FCL
OX-T331413	9341231026447	13 Step	4.1m - 7.2m	18.5kg	FCL



TRADE FIBREGLASS DOUBLE SIDED STEP LADDER 150KG

FEATURES

- Hard-wearing feet - the highest wearing part of a ladder
- Non-clogging hinge - will not seize and collapse
- Extra large head rivets - titan tough rivet for maximum durability
- Internal side stay - avoids damage, stronger

Product code	Barcode	Size	Height	Weight	List Price
OX-T331803	9341231026492	3 Step	0.9m	7kg	FCL
OX-T331804	9341231026508	4 Step	1.2m	8.8kg	FCL
OX-T331806	9341231026515	6 Step	1.8m	11kg	FCL
OX-T331808	9341231026522	8 Step	2.4m	13kg	FCL
OX-T331810	9341231026539	10 Step	3.0m	15.5kg	FCL
OX-T331812	9341231026546	12 Step	3.6m	18kg	FCL



TRADE FIBREGLASS DUAL PURPOSE LADDER 150KG

Step Extension Ladder

FEATURES

- Hard-wearing feet - the highest wearing part of a ladder
- Cross braced side stay - much more stable
- Trapezoidal back steps - comfortable to use in the 'A' shape or folded out
- Extra large head rivets - titan tough maximum durability
- Secure locking latch - guards against accidental dislodgement

Product code	Barcode	Size	Height	Weight	List Price
OX-T331906	9341231026553	6 Step	1.8m - 3.2m	12.9kg	FCL
OX-T331907	9341231026560	7 Step	2.1m - 3.9m	14.7kg	FCL
OX-T331908	9341231026577	8 Step	2.4m - 4.5m	16.9kg	FCL





Indent Container Program

TRADE FIBREGLASS PLATFORM STEP LADDER 150KG



FEATURES

- Large anti-skid work platform with raised edges - keeps feet inside the platform for greater safety and comfort
- Braced platform and folds flat for storage
- Welded back leg - much greater rigidity, safety, durability
- Optional bolt on handrail and gate - full surround safety

Product code	Barcode	Description	Height	Weight	List Price
OX-T332103	9341231026614	3 Step	0.9m	11kg	FCL
OX-T332104	9341231026621	4 Step	1.2m	13kg	FCL
OX-T332105	9341231026638	5 Step	1.5m	15kg	FCL
OX-T332106	9341231026645	6 Step	1.8m	17kg	FCL
OX-T332107	9341231026652	7 Step	2.1m	19kg	FCL
OX-T332108	9341231026669	8 Step	2.4m	21kg	FCL
OX-T332109	9341231033834	9 Step	2.7m	23kg	FCL
OX-T335001	9341231027314	Handrail & Safety Gate Set			FCL

TRADE FIBREGLASS EXTENSION LADDER 150KG



Rope operated

FEATURES

- Side mounted rope - avoids tripping hazard
- Triple pulley - three times easier to lift
- Auto engaging height lock - ensuring your safety
- Heavy duty feet - resists wear
- 'D' shape rungs - for comfortable standing

Product code	Barcode	Size	Height	Weight	List Price
OX-T332009	9341231026584	9 Step	2.8m - 4.7m	12.9kg	FCL
OX-T332010	9341231034169	10 Step	3.2m - 5.3m	15kg	FCL
OX-T332011	9341231026591	11 Step	3.5m - 6.0m	16kg	FCL
OX-T332012	9341231034176	12 Step	3.8m - 6.6m	17kg	FCL
OX-T332013	9341231026607	13 Step	4.1m - 7.2m	20kg	FCL



TRADE FIBREGLASS SINGLE LADDER 150KG

FEATURES

- Heavy duty fibreglass construction
- Heavy duty feet - resists wear
- 'D' shape rungs for comfortable standing
- Safe for electrical work

Product code	Barcode	Size	Height	Weight	List Price
OX-T332208	9341231026676	8 Step	2.5m	7kg	FCL
OX-T332210	9341231026683	10 Step	3.2m	8.5kg	FCL
OX-T332212	9341231026690	12 Step	3.8m	9.5kg	FCL
OX-T332214	9341231026706	14 Step	4.4m	12kg	FCL
OX-T332216	9341231026713	16 Step	5.0m	13.5kg	FCL



TRADE BRICKLAYERS TRESTLE

FEATURES

- Four plank width top beam
- 65mm sq foot under each leg - feet won't sink easily
- High tensile axle bolts
- Heavy duty galvanised finish

Product code	Barcode	Width	Height	List Price
OX-T330206	9341231026980	950mm	600mm	FCL
OX-T330209	9341231026997	950mm	900mm	FCL



TRADE ADJUSTABLE STEEL BRICKLAYERS TRESTLE

Heavy duty steel construction

FEATURES

- Height adjustable with unique locking pin
- Cross brace for added stability and strength
- Large stable feet
- Smooth powder coated finish

Product code	Barcode	Width	Height	List Price
OX-T330312	9341231027000	950mm	800 - 1200mm	FCL
OX-T330318	9341231027017	950mm	1200 - 1800mm	FCL





TRADE PLASTERERS STEEL TRESTLE



Heavy duty steel construction

FEATURES

- Durable welded construction
- Safe working load 250kg
- Large stable feet
- Smooth powder coated finish

Product code	Barcode	Width	Height	List Price
OX-T330109	9341231027024	550mm	900mm	FCL
OX-T330112	9341231027031	550mm	1200mm	FCL
OX-T330115	9341231027048	550mm	1500mm	FCL
OX-T330118	9341231027055	550mm	1800mm	FCL

PRO PLANK LEGS



* Planks not included

FEATURES

- Simply clamps to any wood or alloy plank, or walkboard
- Folds up with plank for easy handling and storage
- Adjustable foot for uneven ground
- Two widths and two heights available
- Can be attached to any length plank

Product code	Barcode	Size	Height	Weight	List Price
OX-PLA600	9421901086923	0.6m - 0.9m	230mm Wide for Walkboard	7.1kg	FCL
OX-PLA900	9421901086930	0.9m - 1.2m	230mm Wide for Walkboard	9.2kg	FCL

TRADE NON ADJUSTABLE "A" FRAME TRESTLE



FEATURES

- Much lighter and more user friendly than steel
- Full width to take two planks
- Fully welded round and box section. Stiles give great strength and durability
- Can be fully handrailed

Product code	Barcode	Height	Weight	List Price
OX-T332612	9341231026911	1.2m	7.5	FCL
OX-T332618	9341231026928	1.8m	10.5	FCL
OX-T332624	9341231026935	2.4m	14.5	FCL
OX-T332630	9341231026942	3.0m	18.0	FCL
OX-T332636	9341231026959	3.6m	22.0	FCL
OX-T332642	9341231026966	4.2m	28.5	FCL
OX-T332648	9341231026973	4.8m	32.0	FCL



PRO ALUMINIUM "A" FRAME TRESTLES

FEATURES

- Much lighter and more user friendly than steel
- Full width to take two planks
- Adjustable foot option for uneven ground
- Fully welded rung and box section stiles give great strength and durability
- Can be fully handrailed

Product code	Barcode	Height	Weight	List Price
OX-AFT120	9341231008030	1.2m	7.5kg	FCL
OX-AFT180	9421901086879	1.8m	10.5kg	FCL
OX-AFT240	9421901086886	2.4m	14.5kg	FCL
OX-AFT300	9421901086893	3.0m	18.0kg	FCL
OX-AFT360	9341231008047	3.6m	22.0kg	FCL
OX-AFT420	9341231008054	4.2m	28.5kg	FCL
OX-AFT480	9341231008061	4.8m	32.0kg	FCL



TRADE FOLDING WORK PLATFORM

FEATURES

- Aluminium industrial work platform
- Fold away legs for easy transport
- Positive locking hinges
- Anti-slip feet for added stability

Product code	Barcode	Width	Weight	List Price
OX-T330403	9341231027147	350mm	8.5kg	FCL
OX-T330404	9341231015823	450mm	10.5kg	FCL





Indent Container Program

PRO OX-PT24 TROWELLING MACHINE 24"

Suitable for edging against walls, particularly on tilt slab applications and working through doorways in finished buildings. Can be used in small areas when a lightweight machine is needed.



FEATURES

- “Dead-man” cut out switch - for maximum safety
- Genuine Honda GX160 - 4 stroke petrol engine for reliability
- Fold down handle - for easy transport
- Rotating guard ring - for close to wall / edging work
- All parts locally stocked - for ultimate back-up

SUPPLIED UNASSEMBLED ONLY

12 MONTH WARRANTY

OIL / GREASE RECOMMENDATIONS	
Engine oil	SAE 10W-30
Gearbox oil	Castrol Alpha SP 200/Shell Omala 220
Grease for base	Castrol Spheerol SX2/Shell Retinax SD2

Product code	Barcode	Fuel Consumption	Fuel Tank Capacity	Engine	Speed Range	Operating Weight	Pitch Range	Trowel Area	Inner Qty	Outer Qty	List Price
OX-PT24	9341231000621	1.81 L/hr	3.6L	4.1kw /5.5hp	70 - 145rpm	53kg	0 - 15°	610mm / 24in	1	1	FCL

PRO OX-PT34 TROWELLING MACHINE 34"

For smaller to medium sized concrete slabs, small factories and warehouses etc.



FEATURES

- Safety cut out switch - for maximum safety
- Genuine Honda GX160 - 4 stroke petrol engine for reliability
- Medium weight - for easy manoeuvring
- Oil viewing glass - to safeguard against gearbox damage
- Heavy duty worm wheel & shaft for longevity
- Robust tilt mechanism for long lasting precise tilt adjustment
- Lifting hook - for easy use with lifting aid
- All parts locally stocked - for ultimate back up
- Supplied fitted with combination blades- ready to use

SUPPLIED UNASSEMBLED ONLY

12 MONTH WARRANTY

OIL / GREASE RECOMMENDATIONS	
Engine oil	SAE 10W-30
Gearbox oil	Castrol Alpha SP 200/Shell Omala 220
Grease for base	Castrol Spheerol SX2/Shell Retinax SD2

Product code	Barcode	Fuel Consumption	Fuel Tank Capacity	Engine	Speed Range	Operating Weight	Pitch Range	Trowel Area	Inner Qty	Outer Qty	List Price
OX-PT34	9341231000638	1.81 L/hr	3.6L	4.1kw / 5.5hp	70 - 145rpm	70kg	0 - 15°	870mm / 34in	1	1	FCL



PRO OX-PT36 TROWELLING MACHINE 36"

Most commonly used size. Used for larger size concrete slabs, factories, warehouses, tilt slabs and car parks. A little extra weight for a faster, flatter result. Performs well with a float pan to prepare for the ultimate finish.

FEATURES

- Safety cut out switch - for maximum safety
- Genuine Honda GX160
-4 stroke petrol engine for reliability
- Lifting hook - for easy use with lifting aid
- Lifting bar - for easy manual handling
- Oil viewing glass - to safeguard against gearbox damage
- Robust tilt mechanism for long lasting precise tilt adjustment
- Heavy weight - for flatter finish
- Heavy duty worm - wheel and shaft for longevity & pan use
- All parts locally stocked - for ultimate back up
- Supplied fitted with combination blades - ready to use



OIL / GREASE RECOMMENDATIONS	
Engine oil	SAE 10W-30
Gearbox oil	Castrol Alpha SP 200/Shell Omala 220
Grease for base	Castrol Spheerol SX2/Shell Retinax SD2

12 MONTH WARRANTY

SUPPLIED UNASSEMBLED ONLY

Product code	Barcode	Fuel Consumption	Fuel Tank Capacity	Engine	Speed Range	Operating Weight	Pitch Range	Trowel Area	Inner Qty	Outer Qty	List Price
OX-PT36	9341231000645	1.81 L/hr	3.6L	4.1kw / 5.5hp	70 - 145rpm	85kg	0 - 15°	910mm / 36in	1	1	\$3449.51
OX-PT36/9	9341231000669	2.9 L/hr	6.0L	6.7kw / 9hp	70 - 145rpm	97kg	0 - 15°	910mm / 36in	1	1	\$3618.67

PRO OX-PT40 TROWELLING MACHINE 40"

Used for larger size concrete slabs, factories, warehouses, tilt slabs and car parks. A slightly larger machine than the 36" but 9kg less weight.

FEATURES

- Safety cut out switch - for maximum safety
- Genuine Honda GX160 - 4 stroke petrol engine for reliability
- Lifting hook - for easy use with lifting aid
- Oil viewing glass - to safeguard against gearbox damage
- Robust tilt mechanism for long lasting precise tilt adjustment
- Heavy weight - for flatter finish
- Heavy duty worm - wheel and shaft for longevity & pan use
- All parts locally stocked - for ultimate back up
- Supplied fitted with combination blades - ready to use



OIL / GREASE RECOMMENDATIONS	
Engine oil	SAE 10W-30
Gearbox oil	Castrol Alpha SP 200/Shell Omala 220
Grease for base	Castrol Spheerol SX2/Shell Retinax SD2

12 MONTH WARRANTY

SUPPLIED UNASSEMBLED ONLY

Product code	Barcode	Fuel Consumption	Fuel Tank Capacity	Engine	Speed Range	Operating Weight	Pitch Range	Trowel Area	Inner Qty	Outer Qty	List Price
OX-PT40	9341231000652	1.81 L/hr	3.6L	4.1kw / 5.5hp	70 - 145rpm	76kg	0 - 15°	1010mm / 40in	1	1	\$3229.52
OX-PT40/9	9341231000676	2.9 L/hr	6.0L	6.7kw / 9hp	70 - 145rpm	88kg	0 - 15°	1010mm / 40in	1	1	\$4467.47



Indent Container Program

PRO OX-PT46 TROWELLING MACHINE 46"

Used for very large slabs such as factories, warehouses, car parks, etc. where a high quality finish is required.



FEATURES

- Safety cut out switch - for maximum safety
- Lifting hook - for easy use with lifting aid
- Genuine Honda GX270 - 4 stroke petrol engine for reliability
- Heavyweight - for flatter finish
- Heavy duty worm wheel & shaft for longevity
- Oil viewing glass - to safeguard against gearbox damage
- Robust tilt mechanism for long lasting precise tilt adjustment
- All parts locally stocked - for ultimate back up
- Supplied fitted with combination blades - ready to use

SUPPLIED UNASSEMBLED ONLY

12 MONTH WARRANTY

OIL / GREASE RECOMMENDATIONS	
Engine oil	SAE 10W-30
Gearbox oil	Castrol Alpha SP 200/Shell Omala 220
Grease for base	Castrol Spheerol SX2/Shell Retinax SD2

Product code	Barcode	Fuel Consumption	Fuel Tank Capacity	Engine	Speed Range	Operating Weight	Pitch Range	Trowel Area	Inner Qty	Outer Qty	List Price
OX-PT46/9	9341231000683	2.9 L/hr	6.0L	6.7kw / 9hp	70 - 125rpm	119kg	0 - 15°	1170mm / 46in	1	1	FCL
OX-PT46/13	9341231000690	4.2 L/hr	6.5L	9.6kw / 13hp	70 - 125rpm	134kg	0 - 15°	1170mm / 46in	1	1	FCL

Replacement Blades
also available in Indent Containers.
See full range on pages 64-65.



PRO WHEELBARROW - STEEL TRAY

FEATURES

- Heavy duty steel tray 99 litres
- Sturdy steel frame
- Heavy duty steel handles
- Needle roller bearings

Product code	Barcode	Size	Inne Qty	Outer Qty	List Price
OX-P301212	9341231030925	99L	1	1	FCL



PRO WHEELBARROW - POLY TRAY

FEATURES

- Heavy duty poly tray 99 litres
- Sturdy steel frame
- Heavy duty steel handles
- Needle roller bearings

Product code	Barcode	Size	Inne Qty	Outer Qty	List Price
OX-P301412	9341231030987	99L	1	1	FCL



TRADE WHEELBARROW - STEEL TRAY

FEATURES

- Heavy duty steel tray 99 litres
- Sturdy steel frame
- Heavy duty steel handles
- Needle roller bearings

Product code	Barcode	Size	Inne Qty	Outer Qty	List Price
OX-T301212	9341231016042	99L	1	1	FCL



TRADE WHEELBARROW - POLY TRAY

FEATURES

- Heavy duty poly tray 99 litres
- Sturdy steel frame
- Heavy duty steel handles
- Needle roller bearings

Product code	Barcode	Size	Inne Qty	Outer Qty	List Price
OX-T301412	9341231016059	99L	1	1	FCL





PRO FIXED HANDLE SCREED

FEATURES

- Ergonomic grip handle with internal support bars
- Heavy duty 'flush-mounted' brackets - allows screed to be used as a straight edge
- Convex profile design - increased lateral strength
- Profile size - 40 x 50mm



Product Code	Barcode	Overall Length	Inner Qty	Outer Qty	List Price
OX-P021512	9341231000287	1200mm	N/A	4	\$59.15
OX-P021515	9341231000294	1500mm	N/A	4	\$74.00
OX-P021518	9341231000300	1800mm	N/A	4	\$74.75
OX-P021521	9341231000317	2100mm	N/A	4	\$85.35
OX-P021524	9341231000324	2400mm	N/A	4	\$92.60
OX-P021527	9341231000331	2700mm	N/A	4	\$96.35
OX-P021530	9341231000348	3000mm	N/A	4	\$110.20
OX-P021536	9341231000355	3600mm	N/A	4	\$134.50

Also Available in the Indent Program:

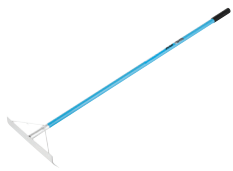

ALUMINUM CONCRETE RAKES

page
45



TELESCOPIC HANDLES

page
49



CLIP TOGETHER HANDLES

page
50

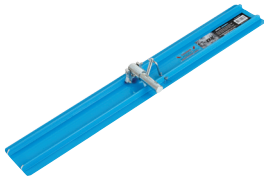

BULLFLOATS

page
48

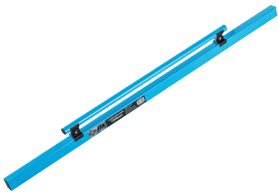

CONCRETE SCREEDS

page
47



CONCRETE SCREEDS WITH VIALS

page
47

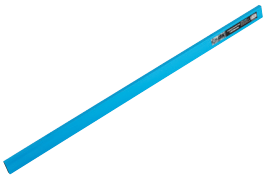

STANDARD STRAIGHT EDGES

page
46

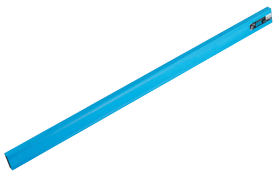

HEAVY DUTY STRAIGHT EDGES

page
46



PROFILE PROPS

page
79



SAW HORSES

page
165



Planograms

An instant transformation that will produce an interest from all your customers. Prove the power of OX to increase your sales with very little floor and wall space.

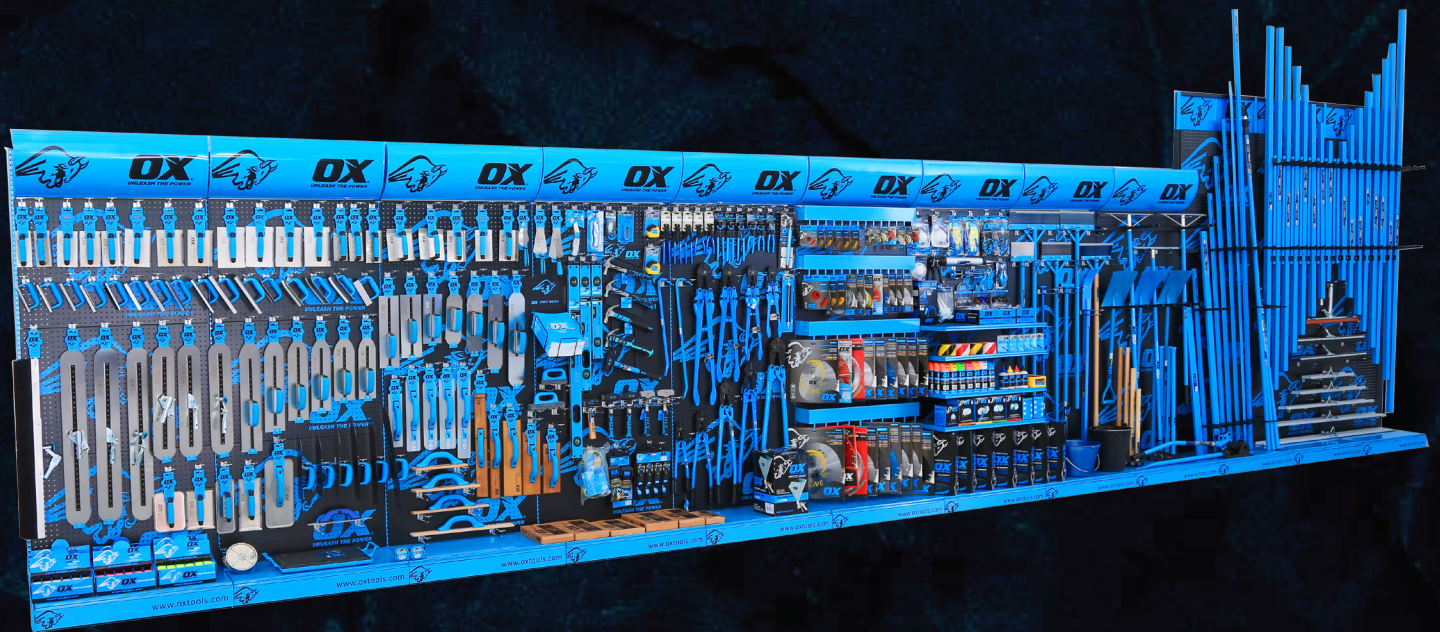

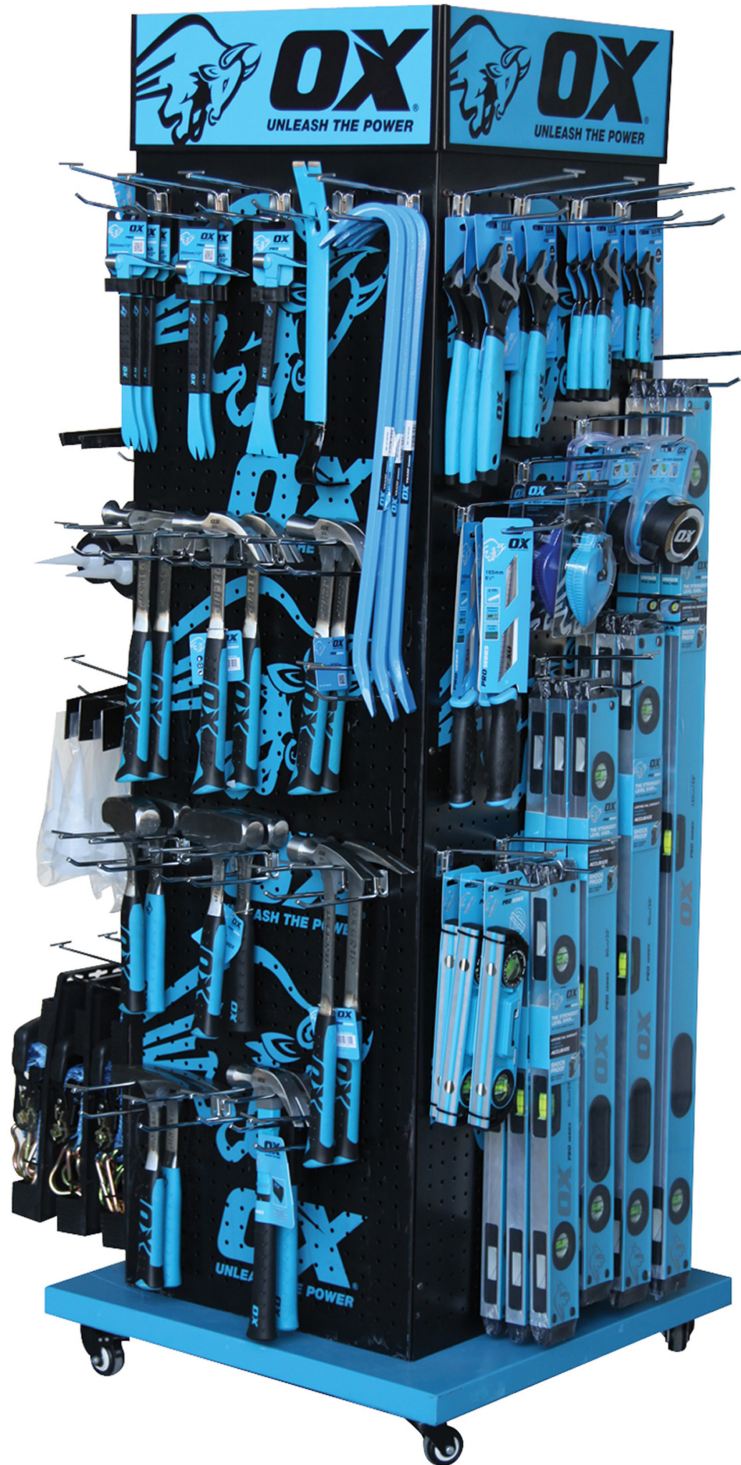



DIAMOND CORE RANGE



DIAMOND CORE RANGE

Total List Price	11, 528.36
# of SKUs	50
# of Items	114
Display area	1.78m ²
Footprint	0.47m ²
Dimensions	W 0.95m
	D 0.5m
	H 2.42m

DIAMOND 4X4 RANGE FLATTENED

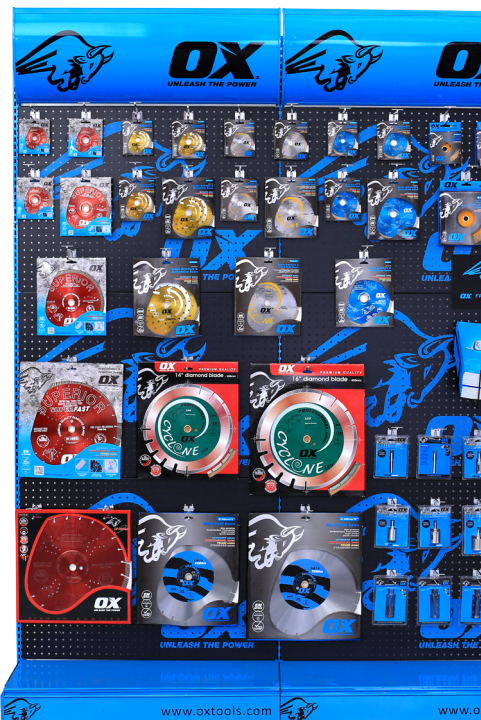

DIAMOND 4 X 4 RANGE FLATTENED

Total List Price	\$ 9,060.45
# of SKUs	41
# of Items	114
Display area	3.57m ²
Footprint	0.93m ²
Dimensions	W 1.86m
	D 0.5m
	H 2.42m



CONCRETING CORE RANGE

CONCRETING CORE RANGE	
Total List Price	\$ 13,018.31
# of SKUs	100
# of Items	301
Display area	9.52m ²
Footprint	2.30m ²
Dimensions	W 4.61m
	D 0.5m
	H 3.05m



BRICKLAYING CORE RANGE

BRICKLAYING CORE RANGE	
Total List Price	\$ 11,370.66
# of SKUs	102
# of Items	340
Display area	5.35m ²
Footprint	1.39m ²
Dimensions	W 2.78m
	D 0.5m
	H 2.42m

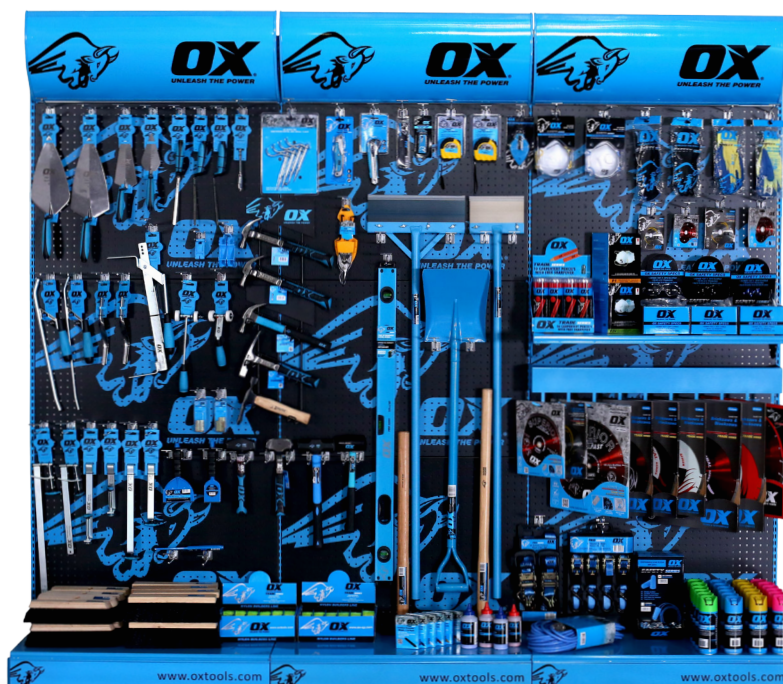



PLASTERING CORE RANGE



PLASTERING CORE RANGE

Total List Price	\$ 5,642.52
# of SKUs	75
# of Items	245
Display area	5.95m ²
Footprint	1.39m ²
Dimensions	W 2.78m
	D 0.5m
	H 3.05m

RENDERING CORE RANGE



RENDERING CORE RANGE

Total List Price	\$ 5,566.14
# of SKUs	81
# of Items	242
Display area	7.73m ²
Footprint	1.85m ²
Dimensions	W 3.69m
	D 0.5m
	H 3.05m



TILING CORE RANGE

TILING CORE RANGE	
Total List Price	\$ 8,837.82
# of SKUs	115
# of Items	306
Display area	7.73m ²
Footprint	1.85m ²
Dimensions	W 3.69m
	D 0.5m
	H 3.05m

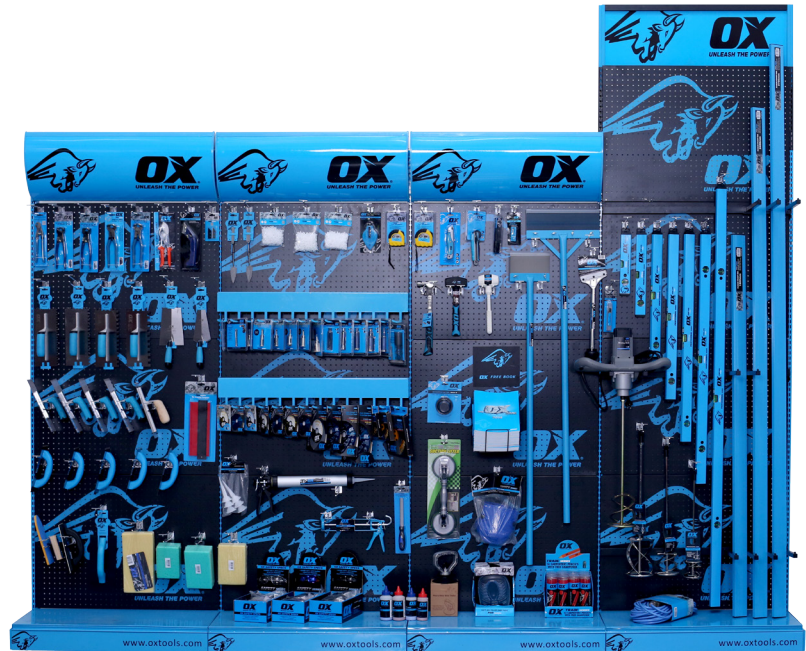

MASONRY EXTENDED RANGE

MASONRY EXTENDED RANGE	
Total List Price	\$ 8,299.16
# of SKUs	108
# of Items	238
Display area	11.90m ²
Footprint	2.76m ²
Dimensions	W 5.52m
	D 0.5m
	H 3.05m

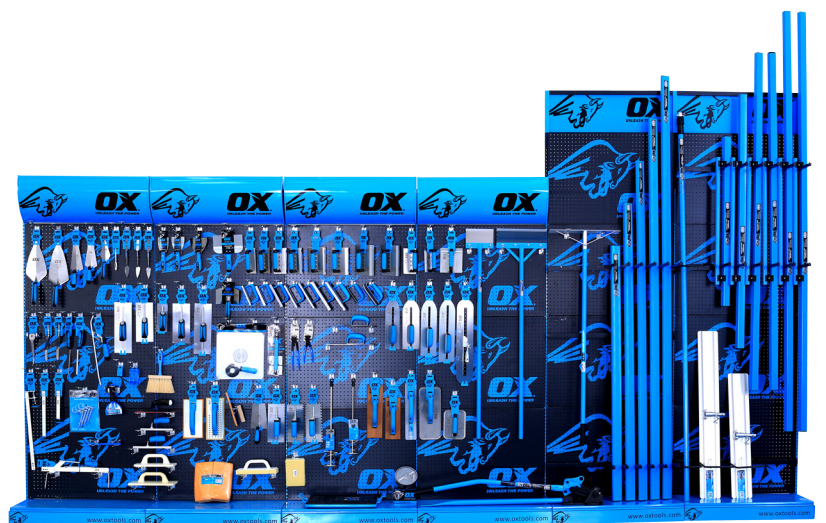



MASONRY 4X4 RANGE



MASONRY 4 X 4 RANGE

Total List Price	\$ 3,397.32
# of SKUs	44
# of Items	114
Display area	3.7m ²
Footprint	0.4m ²
Dimensions	W 0.7m
	D 0.7m
	H 1.8m

STRIKING AND STRUCK RANGE

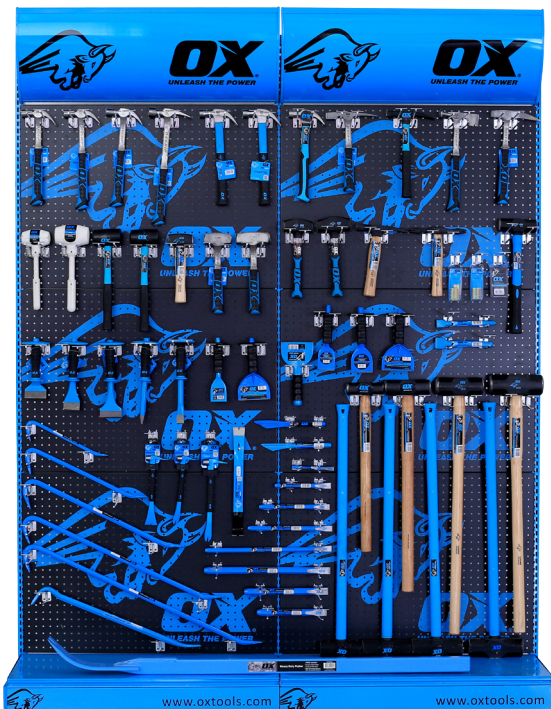

STRIKING & STRUCK RANGE

Total List Price	\$ 4,728.92
# of SKUs	68
# of Items	145
Display area	3.57m ²
Footprint	0.93m ²
Dimensions	W 1.86m
	D 0.5m
	H 2.42m



SPIRIT LEVELS RANGE

SPIRIT LEVELS	
Total List Price	\$ 2304.03
# of SKUs	8
# of Items	24
Display area	3.7m ²
Footprint	0.4m ²
Dimensions	W 0.7m
	D 0.7m
	H 1.8m



GENERAL HAND TOOLS 4X4 RANGE

GENERAL HAND TOOLS 4 X 4 RANGE	
Total List Price	\$ 4,760.82
# of SKUs	45
# of Items	139
Display area	3.7m ²
Footprint	0.4m ²
Dimensions	W 0.7m
	D 0.7m
	H 1.8m





SAFETY RANGE



SAFETY RANGE	
Total List Price	\$2,565.58
# of SKUs	34
# of Items	90
Display area	1.78m ²
Footprint	0.47m ²
Dimensions	W 0.95m
	D 0.5m
	H 2.42m

TOOL STORAGE RANGE



TOOL STORAGE RANGE	
Total List Price	\$ 1,174.00
# of SKUs	15
# of Items	28
Display area	1.78m ²
Footprint	0.47m ²
Dimensions	W 0.95m
	D 0.5m
	H 2.42m



LANDSCAPING CORE RANGE

LANDSCAPING CORE RANGE

Total List Price	\$ 13,808.13	
# of SKUs	180	
# of Items	W	527
Display area	D	13.08m ²
Footprint	H	3.22m ²





Merchandising and Promotional

Customized OX planograms available to fit your store. Call your dedicated regional account manager for pricing and additional information.







FULL HEIGHT MERCHANDISING DISPLAY STAND

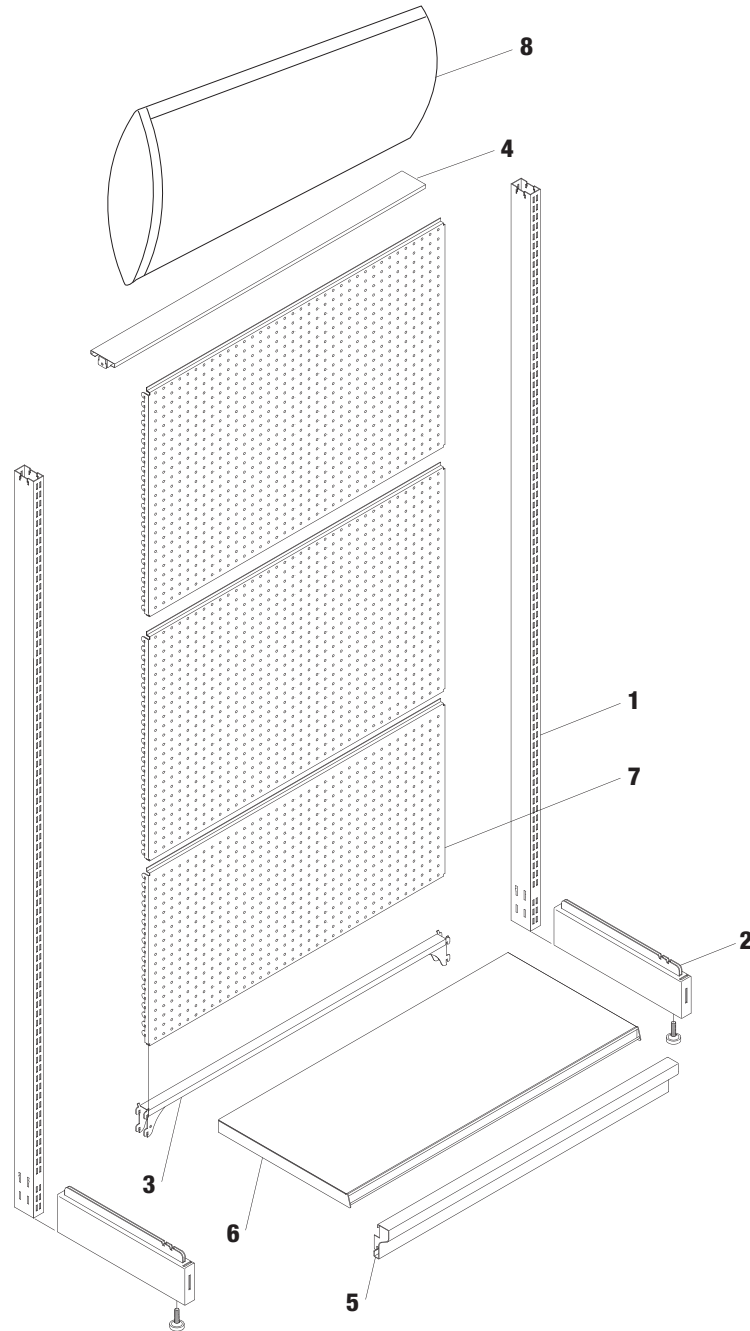

Number	Product code	Description	1 Bay Quantity	2 Bay Quantity	3 Bay Quantity	4 Bay Quantity	5 Bay Quantity
1	ME-DSBP02	Back Pillar - Full Height	2	3	4	5	6
2	ME-DSBF01	Base Foot - Single	2	3	4	5	6
3	ME-DSBB36	Pillar Brace - Bottom	1	2	3	4	5
4	ME-DSBT36	Pillar Brace - Top	1	2	3	4	5
5	ME-DSKB36	Kick Board	1	2	3	4	5
6	ME-DSSS36	Standard Shelf	1	2	3	4	5
7	ME-DSPO36	Pegboard Panel	3	6	9	12	15
8	ME-DSHB36	Header Box	1	2	3	4	5



HALF HEIGHT MERCHANDISING DISPLAY STAND

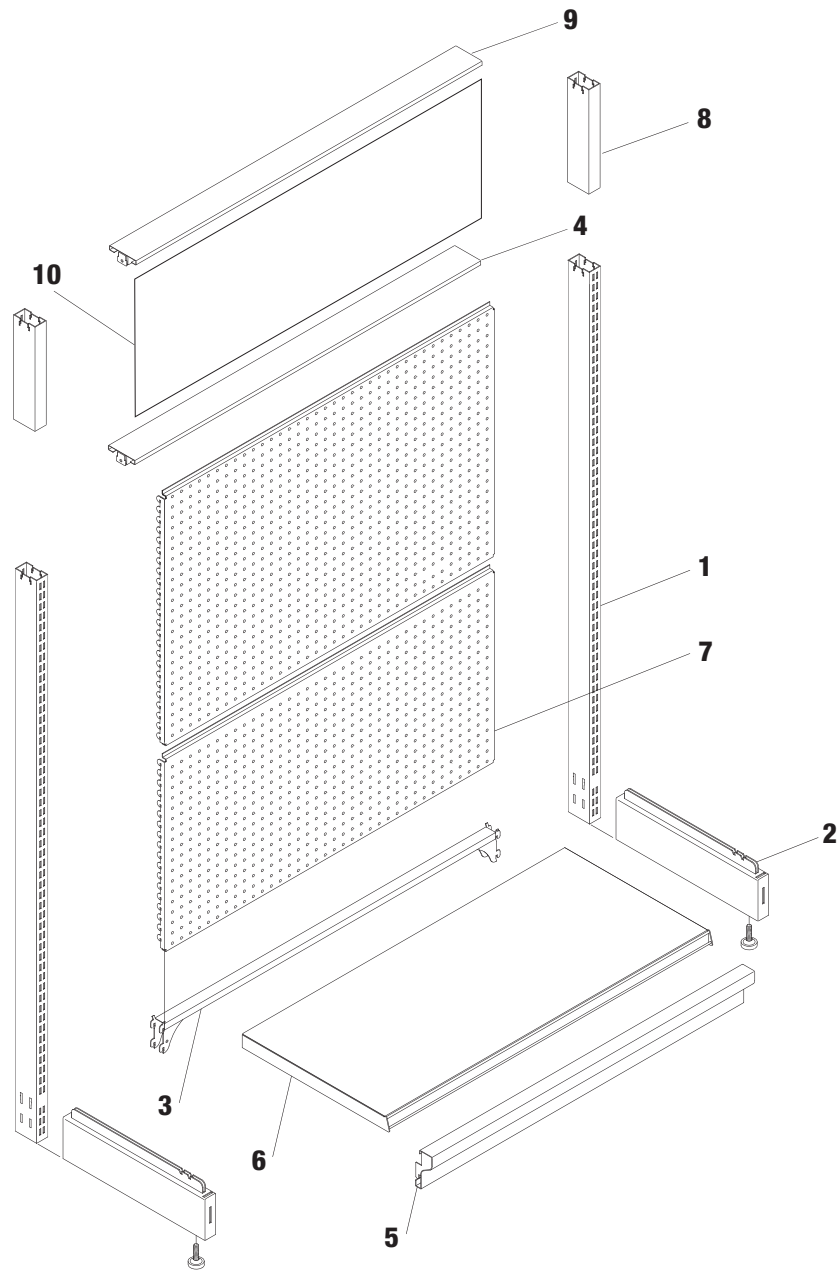

Number	Product code	Description	1 Bay Quantity	2 Bay Quantity	3 Bay Quantity	4 Bay Quantity	5 Bay Quantity
1	ME-DSBP01	Back Pillar - Half Height	2	3	4	5	6
2	ME-DSBF01	Base Foot - Single	2	3	4	5	6
3	ME-DSBB36	Pillar Brace - Bottom	1	2	3	4	5
4	ME-DSBT36	Pillar Brace - Top	1	2	3	4	5
5	ME-DSKB36	Kick Board	1	2	3	4	5
6	ME-DSSS36	Standard Shelf	1	2	3	4	5
7	ME-DSPO36	Pegboard Panel	3	6	9	12	15
8	ME-DSSH01	Sign Holder - Side Rail	2	3	4	5	6
9	ME-DSSH00	Sign Holder - Top Rail	1	2	3	4	5
10	ME-DSC036	Corflute Sign	1	2	3	4	5



BACK PILLAR

FEATURES

- 2 heights available

Product Code	Barcode	Description	Outer Qty	List Price
ME-DSBP01	9341231033964	Half Back Pillar	4	\$57.48
ME-DSBP02	9341231033858	Full Back Pillar	4	\$89.54



BACK PILLAR EXTENSION - 400mm

FEATURES

- To be used to extend back pillar to suit 4 pegboard panels
- For use on concrete screed displays

Product Code	Barcode	Description	Outer Qty	List Price
ME-DSPE40	9328217015640	Back Pillar Extension	4	\$23.90



BASE FOOT - SINGLE

FEATURES

- To be used with one sided stands

Product Code	Barcode	Description	Outer Qty	List Price
ME-DSBF01	9341231033940	Base Foot - Single	6	\$25.72

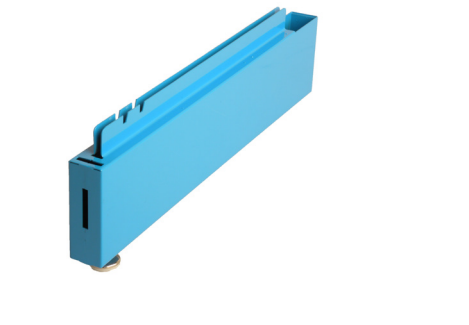

BASE FOOT - DOUBLE

FEATURES

- To be used with back to back stands

Product Code	Barcode	Description	Outer Qty	List Price
ME-DSBF02	9341231033957	Base Foot - Double	6	\$47.50

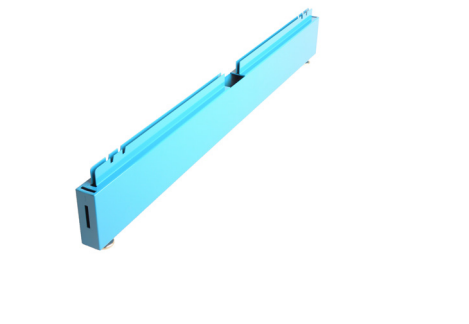



PILLAR BRACE – TOP

FEATURES

- Top internal brace for extra support

Product Code	Barcode	Description	Outer Qty	List Price
ME-DSBT36	9341231033865	Pillar Brace - Top	6	\$9.08

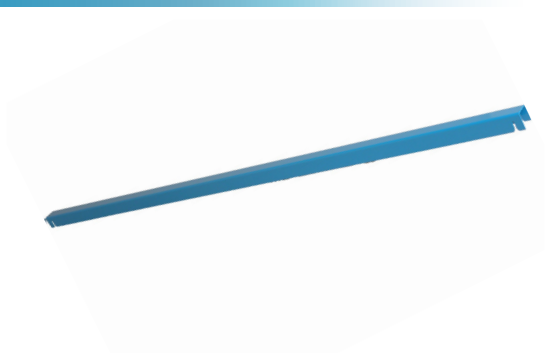

PILLAR BRACE – BOTTOM

FEATURES

- Bottom internal brace for extra support

Product Code	Barcode	Description	Outer Qty	List Price
ME-DSBB36	9341231033841	Pillar Brace - Bottom	6	\$10.89



KICKBOARD

FEATURES

- Cover to prevent objects falling under the stand

Product Code	Barcode	Description	Outer Qty	List Price
ME-DSKB36	9341231033896	Kickboard - Bottom	6	\$24.19



SHELF BRACKETS – PAIR

FEATURES

- Brackets to support shelves
- Available in two sizes

Product Code	Barcode	Suits	Outer Qty	List Price
ME-DSSB35	9328217015541	ME-DSMS36	6	\$14.28
ME-DSSB45	9341231033919	ME-DSSS36	6	\$17.01

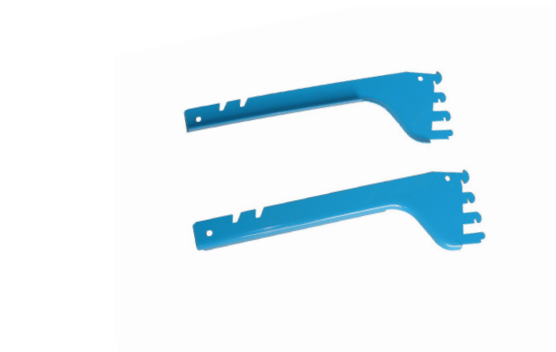



STANDARD SHELF

FEATURES

- 2 widths available

Product Code	Barcode	Description	Outer Qty	List Price
ME-DSMS36	9328217015534	Shelf - Medium	3	\$66.67
ME-DSSS36	9341231033933	Shelf - Standard	3	\$94.86

HEADER BOX

FEATURES

- For use on full height merchandise stands

Product Code	Barcode	Width (mm)	List Price
ME-DSHB36	9341231033889	905	\$208.18

CORFLUTE SIGN

FEATURES

- For use on half height merchandise stands

Product Code	Barcode	Size (mm)	Outer Qty	List Price
ME-DSCO36	9341231033872	910 x 246	24	\$86.70

SIGN HOLDER – TOP RAIL

FEATURES

- Top support for corflute sign

Product Code	Barcode	Description	Outer Qty	List Price
ME-DSSH00	9341231033995	Sign Holder - Top Rail	6	\$11.25



SIGN HOLDER – SIDE RAILS

FEATURES

- Side support for corflute sign

Product Code	Barcode	Description	Outer Qty	List Price
ME-DSSH01	9341231033926	Sign Holder - Side Rails	6	\$9.92

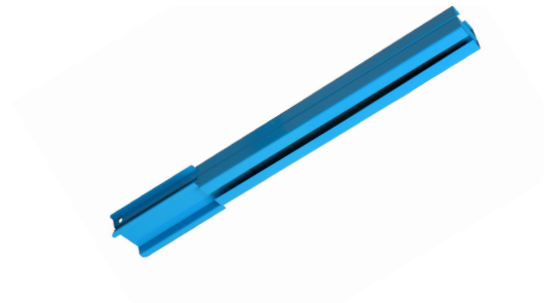

PEGBOARD PANEL

FEATURES

- Multiple peg holes to allow for versatile hook positioning

Product Code	Barcode	Size (mm)	Outer Qty	List Price
ME-DSP036	9341231033902	905 x 650	3	\$120.18

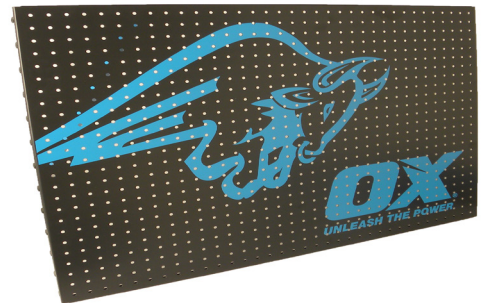

HOOKS

FEATURES

- Zinc plated
- Includes plastic price tag holder

Product Code	Barcode	Length (mm)	Outer Qty	List Price
OX-D310115	9341231007330	150	25	\$3.36
OX-D310130	9341231007347	300	25	\$4.11

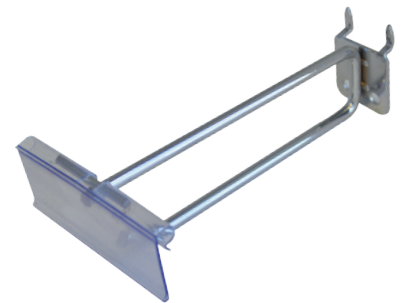

CROSS RAIL

FEATURES

- Rail to hold pegs for concrete screeds

Product Code	Barcode	Description	Outer Qty	List Price
ME-DSCR36	9341231033971	Heavy Duty Cross Rail	6	\$48.60





CROSS RAIL PEG



FEATURES

- Clip on cross rail to hold concrete screed

Product Code	Barcode	Size (mm)	Outer Qty	List Price
ME-DSRP30	9341231033988	300	6	\$23.03

OX HAMMER RACK



FEATURES

- Steel Construction
- Holds 12 Hammers (hammers not included)

Product Code	Barcode	Size (mm) WxDxH	Outer Qty	List Price
ME-DSHR03	9341231014345	250x160x500mm	N/A	\$42.52

HANDLE HOLDER

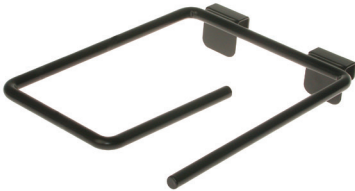

FEATURES

- Used to hold telescopic handles and straight edges

Product Code	Barcode	Description	Outer Qty	List Price
ME-DSHH01	9328217015602	Top	6	\$30.92
ME-DSHH02	9328217015619	Bottom	6	\$33.34

BULLFLOAT HOLDER



FEATURES

- Used to hold bullfloats

Product Code	Barcode	Description	Outer Qty	List Price
ME-DSBH01	9328217015626	Top	6	\$29.75
ME-DSBH02	9328217015633	Bottom	6	\$33.34

CUT CASES



FEATURES

- Solid cardboard construction
- Ideal for displaying small components

Product Code	Barcode	Width (mm)	Outer Qty	List Price
OX-DS450114	9341231034732	140	5	\$45.11
OX-DS450132	9341231034749	320	5	\$48.74
OX-DS450158	9341231034756	580	5	\$55.06



4 SIDED MOBILE DISPLAY STAND

FEATURES

- Mobile display with lockable castors
- Built-in storage with lockable door
- Only takes 0.37m of floor space
- Holds approximately 30-45 SKUs
- 0.7m x 0.7m x 1.8m (L x W x H)

Product Code	Barcode	Quantity of hooks	List Price
ME-DSMS04	9341231035708	60	\$1133.77



SPIRIT LEVEL DISPLAY STAND

FEATURES

- Steel construction
- 12 level capacity
- 355mm x 265mm x 460mm (L x W x H)

Product Code	Barcode	Capacity	List Price
OXPOS-LEVEL1	9341231035463	12 Levels	\$229.27



DUMP BIN

FEATURES

- Solid cardboard construction
- 5 removable insert trays
- 600 x 600 x 1200 mm (L x W x H)

Product Code	Barcode	Quantity of trays	Outer Qty	List Price
OX-DS450205	9341231034763	5	2	\$191.42





DIAMOND BLADE COUNTER DISPLAY



FEATURES

- Solid cardboard construction
- Suits 4", 5" & 9" Blades (Blades not included)

Product Code	Barcode	Suits	Outer Qty	List Price
OX-DS451703	9341231015434	4", 5", & 9"	1	\$36.30

LADDER DISPLAY



FEATURES

- Steel construction
- Castors for easy manoeuvrability
- Suits up to 7 ladders (ladders not included)

Product Code	Barcode	Capacity	Outer Qty	List Price
OXPOS-LS	9341231035654	7 Ladders	1	\$312.90

RETAIL CATALOGUE



FEATURES

- A5 compact size
- 200 pages

Product Code	Barcode	Size	Outer Qty	List Price
RETAILCAT2016E1	9341231015816	A5	64	\$5.00

CATALOGUE DISPLAY



FEATURES

- Steel Construction
- Suits 25 A4 Catalogues (catalogues not included)

Product Code	Barcode	Capacity	Outer Qty	List Price
ME-DSCH01	9341231014352	25	1	\$34.68



POSTERS

BARCLAMPS

Product Code	Barcode	Size(mm)	Outer Qty	List Price
OX-D452201	9341231016066	841 x 1189	1	\$68.57
OX-D452301	9341231016165	594 x 841	1	\$31.70

CLAW HAMMERS

Product Code	Barcode	Size(mm)	Outer Qty	List Price
OX-D452202	9341231016073	841 x 1189	1	\$68.57
OX-D452302	9341231016172	594 x 841	1	\$31.70

KNIVES

Product Code	Barcode	Size(mm)	Outer Qty	List Price
OX-D452203	9341231016080	841 x 1189	1	\$68.57
OX-D452303	9341231016189	594 x 841	1	\$31.70

SPIRIT LEVELS

Product Code	Barcode	Size(mm)	Outer Qty	List Price
OX-D452204	9341231016097	841 x 1189	1	\$68.57
OX-D452304	9341231016196	594 x 841	1	\$31.70

NOTCH TROWELS

Product Code	Barcode	Size(mm)	Outer Qty	List Price
OX-D452205	9341231016103	841 x 1189	1	\$68.57
OX-D452305	9341231016202	594 x 841	1	\$31.70

FINISHING TROWELS

Product Code	Barcode	Size(mm)	Outer Qty	List Price
OX-D452206	9341231016110	841 x 1189	1	\$68.57
OX-D452306	9341231016219	594 x 841	1	\$31.70

SUPERIOR BLADES

Product Code	Barcode	Size(mm)	Outer Qty	List Price
OX-D452207	9341231016127	841 x 1189	1	\$68.57
OX-D452307	9341231016226	594 x 841	1	\$31.70

BRICK TROWELS

Product Code	Barcode	Size(mm)	Outer Qty	List Price
OX-D452208	9341231016134	841 x 1189	1	\$68.57
OX-D452308	9341231016233	594 x 841	1	\$31.70

POINTED FINISHING TROWELS

Product Code	Barcode	Size(mm)	Outer Qty	List Price
OX-D452209	9341231016141	841 x 1189	1	\$68.57
OX-D452309	9341231016240	594 x 841	1	\$31.70

HAND SAWS

Product Code	Barcode	Size(mm)	Outer Qty	List Price
OX-D452210	9341231016158	841 x 1189	1	\$68.57
OX-D452310	9341231016257	594 x 841	1	\$31.70





LOSS OF TENSION



CAUSES

Using the wrong blade on a specific material. A blade specifically designed and manufactured for cutting tiles will wear out extremely fast if used on highly-abrasive material such as block.

Inadequate water is supplied to the blade.

Bad spindle bearings, worm mounting arbor, or misaligned shaft.

Loss of power, resulting from loose drive belts or improper voltage.

REMEDIES

Avoid using general purpose specifications for cutting a single specific material. General purpose diamond blades are designed to cut a wide range of materials. Since it is unlikely an operator will be cutting an equal amount of both hard and soft materials at all times, this is not the most economical method of cutting.

Make sure water hoses are clean and free from any blockages. Approximately nine litres of water per minute are required to properly cool a masonry saw blade. On concrete saws, 9-22 litres per minute are required.

Replace defective parts.

See machine manual for proper belt tightening, replace worn belts, make sure proper line voltage is being supplied to the motor.

BLADE WOBBLER

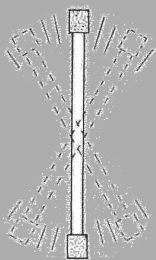

Blade is too hard for material being cut.

Blade has become dull as a result of being used on too hard a material.

Blade does not cut material it was specified for.

Insufficient power, not allowing blade to cut properly. Often, the blade will stall in the cut.

Select the proper blade specification for the material being cut. Consult blade recommendation chart.

Dress or sharpen with mortar droppings or by cutting a lightweight abrasive building block to expose diamonds. If continual dressing is required, the blade specification is too hard for the material being cut.

First, make sure the blade is correct according to the blade recommendation chart. If the blade is correct, allow it to dress itself on the material to be cut. If it does not dress itself, sharpen it as you would a dull blade, according to the procedure described above.

Tighten belts in accordance with machine maintenance instructions. Use correct voltage at motor and adequate horsepower for cutting application.



SEGMENT LOSS

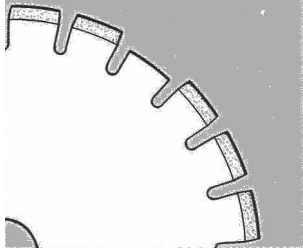

CAUSES

On masonry saws, the material is not held firmly, which causes the blade to twist or jam in the cut and loosen the segment.

Overheating is due to inadequate supply of water or complete loss of water. This is usually accompanied by discolourations which appear on the steel centre near the area of segment loss.

Steel centre is worn thin as a result of undercutting by abrasive fines generated during cutting. The steel centre (blank) wears to a knife edge, weakens and causes a segment to be separated.

Defective blade collars cause the blade to flutter in the cut or fail to adequately support the blade in perfect alignment.

Blade is too hard for material being cut, causing excessive dullness and segment separation due to impact or fatigue. This can also cause frictional heat that can melt the braze when insufficient water is supplied to the blade.

Blade is cutting out of round resulting in a pounding impact.

Improper blade tension causes high pressure on the segments and subsequent failure of the brazed joint.

REMEDIES

Hold the material firmly against the backstop.

Provide adequate water flow to both sides of the blade. Look for line blockages. On concrete saws, temporary complete loss of water can result from equipment running over the water feed hoses.

Use sufficient water to flush fines out of the cut.

If generated fine s are highly abrasive, blades with undercut protection.

Clean foreign material from the blade clamping disc surfaces, ore replace clamping discs if they are under manufacturer's recommended diameter.

Use the proper blade specifications for the material being cut.

Replace worn bearing, realign blade shaft, or replace worn spindle.

Make sure the running speed of equipment is specified when ordering blades. On concrete saws, the spindle speed should be checked with a tachometer to ensure that each diameter blade is running at the recommended cutting speed and blade-tensioned speed.

DISTORTED CENTRE STEEL



Inadequate tightening of the blade on concrete saw mounting shaft. This causes drive pin to force its way through blade blank.

Dropping saw head with mounted blade particularly on concrete saws. Also dropping objects on unmounted blade distorts blade blanks.

Tighten clamping nut securely.

Avoid dropping the blade. Protect blade from abuse and handle with care.

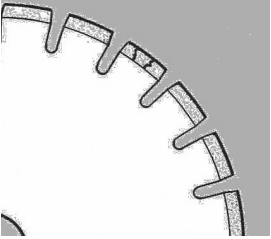
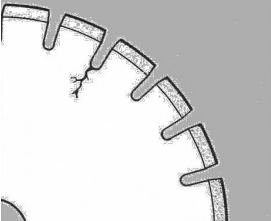

	CAUSES	REMEDIES
<p>UNEVEN SEGMENT</p> 	<p>Insufficient water, generally to one side of the blade, reduces side clearance and does not flush out fines.</p> <p>Equipment defects cause the segment to wear unevenly.</p> <p>Saw head is misaligned.</p>	<p>Flush out the water system. Make certain that water is adequately and evenly distributed to both side of the blade.</p> <p>Replace bad bearings, worn or misaligned spindle. On concrete saws, the engine must run smoothly to prevent harmonic vibrations which cause the blade to pound on a regular cycle basis.</p> <p>Check saw head alignment for squareness both vertically and horizontally.</p>
<p>CRACKS IN SEGMENTS</p> 	<p>The blade is too hard for the material being cut.</p>	<p>Use blade with a softer bond.</p>
<p>CRACKS IN STEEL CENTER</p> 	<p>Blade flutters in a cut as a result</p> <p>Blade specification is too hard for material being cut.</p> <p>Forcing blade in operation.</p> <p>Twisting blade in cut.</p>	<p>Tighten the blade clamping disc nut. Be sure that the blade is running at the properly tensioned speed and that the drive pin is functioning properly.</p> <p>Use softer blade bond to eliminate stresses which create cracks.</p> <p>Allow blade to cut freely without bouncing.</p> <p>Ensure blade is kept in straight line do not force around corners.</p>

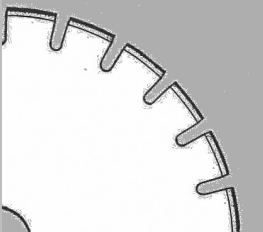
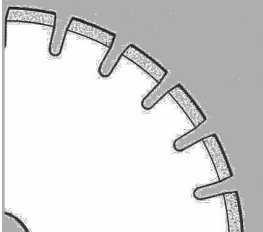

SHORT LIFE 	CAUSES	REMEDIES
BLADE WILL NOT CUT 	<p>Using the wrong blade on a specific material. A blade specifically designed and manufactured for cutting tiles will wear out extremely fast if used on highly-abrasive material such as block.</p> <p>Inadequate water is supplied to the blade.</p> <p>Bad spindle bearings, worm mounting arbor, or misaligned shaft.</p> <p>Loss of power, resulting from loose drive belts or improper voltage.</p> <p>Blade is too hard for material being cut.</p> <p>Blade has become dull as a result of being used on too hard a material.</p> <p>Blade does not cut material it was specified for.</p> <p>Insufficient power, not allowing blade to cut properly. Often, the blade will stall in the cut.</p>	<p>Avoid using general purpose specifications for cutting a single specific material. General purpose diamond blades are designed to cut a wide range of materials. Since it is unlikely an operator will be cutting an equal amount of both hard and soft materials at all times, this is not the most economical method of cutting.</p> <p>Make sure water hoses are clean and free from any blockages. Approximately nine litres of water per minute are required to properly cool a masonry saw blade. On concrete saws, 9-22 litres per minute are required.</p> <p>Replace defective parts.</p> <p>See machine manual for proper belt tightening, replace worn belts, make sure proper line voltage is being supplied to the motor.</p> <p>Select the proper blade specification for the material being cut. Consult blade recommendation chart.</p> <p>Dress or sharpen with mortar droppings or by cutting a lightweight abrasive building block to expose diamonds. If continual dressing is required, the blade specification is too hard for the material being cut.</p> <p>First, make sure the blade is correct according to the blade recommendation chart. If the blade is correct, allow it to dress itself on the material to be cut. If it does not dress itself, sharpen it as you would a dull blade, according to the procedure described above.</p> <p>Tighten belts in accordance with machine maintenance instructions. Use correct voltage at motor and adequate horsepower for cutting application.</p>



Diamond Blade Troubleshooting Guide

BLADE BORE OUT-OF-ROUND

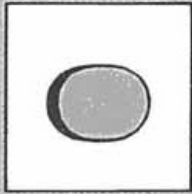

CAUSES

Blade collar is not properly tightened, permitting blade to either rotate or vibrate on shaft.

Blade collars are worn or dirty not allowing proper blade clamping.

Blade is not properly mounted.

REMEDIES

Tighten the spindle nut with a spanner to make certain that the blade is adequately secured to prevent rotation on shaft.

Clean blade collars, making sure they are not worn. Tighten arbor nut properly.

Make certain the blade is mounted on the proper shaft diameter before tightening arbor nut. On concrete saws, make certain the pin hole slides over arbor drive pin. Never depend on the drive pin to actually drive the blade. A drive pin is simply a safety measure to prevent the blade from spinning on its spindle should the nut become loose.

UNDERCUTTING STEEL CENTRE



Abrading or wearing away of the steel centre faster than the diamond segment is due to highly abrasive fines generated during cutting.

Use as much water as possible to flush out fines generated during cutting or use blades with undercut protection. NOTE: Blades with undercut protection are not always the final answer to eliminating undercutting. Are must still be taken to provide sufficient water to the steel centre are immediately adjacent to the segment. This is especially important when making deep cuts.

BLADE WORN OUT-OF-ROUND

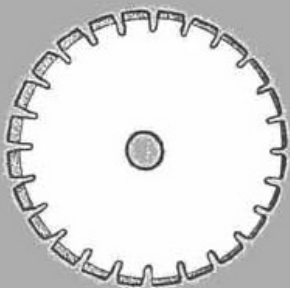

Shaft bearings on masonry or concrete saws are worn, causing the blade to run eccentrically and wear out-of-round.

Engine is not properly tuned on concrete saws, causing surges in blade rotation.

Blade spindle hole is damaged from previous mis-mounting.

Blade mounting spindle is worn. A groove may have been scoured on the mounting spindle as a result of previous blades spinning on the arbor. When a new blade is placed on such a worn spindle, it seats improperly and runs eccentrically.

Blade slips on arbor shaft.

Bond is too hard for material causing machine to 'pound' at regular intervals, wearing one half of the blade more than the other half.

Install new blade shaft bearings or blade shaft, as required.

Tune engine according to saw manufacturer's manual.

For large diameter blades it may be possible to rebraze segments to a new centre.

Replace worn shaft or spindle bushing.

On a masonry saw, tighten the blade collar. On a concrete saw, make certain that the drive pin is functioning.

Use proper blade specification.



A	Door Clamp 139	J
Acid Brush 81, 95	Door Gauges 77	Jabsaw 149
Adjustable Wrench 160	Dori Blocks 77	Joint Knives 85
All Sides Up Float 58	Dry Core Drills 35-36, 212	Jointers 70-71
Aluminium Hawk 90	Drywall Hammer 119	Joint Raker 72
Aviation Snips 149	Dust Masks 179, 180	
	Dutch Pins 72-73	K
B	E	Knee Pads 182
Bags 172	Ear Plugs 178-179	Kneeling Board 61
Bannister Brush 81	Edgers 51-54, 58, 87	Knives
Bar Clamps 138-139	End Cutting Nippers 42-43	Folding Knife 144-145
Barrier Tape 183	Extension Leads 169	Joint Knife 85
Bolsters 154	F	Replacement Blades 146
Bolt Cutters 44	Fibro Cutter 146	Score 'n' Snap Knife 84
Brick Bolster 154	Finishing Broom 60	Snap Off 144
Brick Carrier 79	Finishing Trowels 56-57, 92-93	Taping Knife 85
Brick Hammer 118, 119	Floats 54-55, 59	Trimming Knife 144-146
Brickies Brushes 81	Floor Scrapers 166-167	Utility Knife 146
Brick Jointer 70	Folding Knife 144-145	L
Brick Splitter 80	G	Levels 110, 132-134
Bricklayers Clamp 78	Gauging Trowels – Brickies 68	Spirit Level 132, 134
Buckets 168-169	Gauging Trowels – Tilers 107	Tilers Level 110
Builders Line 73	Gloves 181	Torpedo Level 133
Bullfloats 48	Grouters 113	Latex Gloves 181
C	Grout Removers 108	Leather Gear 173-175
Carpenters Pencils 139-140	Groovers 50-51, 58	Line Blocks 74
Carpenters Square 129	Gumboots 182	Line Pin 74
Caulking Gun 165	H	Lumber Crayons 135
Chalk Line Reels 134-135	Hacksaws & Blades 147-148	M
Chalk Refills 135	Hammers 118-123	Magnesium Float 55-56
Chisels 140, 153, 155	Brick Hammer 118-119	Mallets 122-123
Chisel Holder 174	Claw Hammer 118-120	Margin Trowel 69
Clamps - Bar 138-139	Club Hammer 120-121	Masks 179-180
Clamps - Door 139	Demolition Hammer 121	Masonry Bucket 169
Claw Bar 152	Display Rack 238	Masonry Saw 148
Clip Together Handle 50	Drywall Hammer 119	Merchandise Stands 232-239
Cold Chisel 153, 155	Framing Hammer 118	Midget Trowel 93
Combination Square 128	Rock Pick 119	Mitre Box 87
Concrete Rakes 45	Rubber Mallet 122-123	Mixing Drill 98
Concrete Sprayer 62-63	Scuth Hammer 123	Mixing Paddles 99-101
Cordless Drill Holder 174	Sledge Hammer 122	Mortar Raking Blade 207
Core Drills 212, 218	Hammer Holster 173	Mortar Smoothing Tools 69
Corner Edger 87	Hammer Rack 238	Mortar Spike 75
Corner Trowels – External 86	Hand Sander 85	
Corner Trowels – Internal 84	Handy Bar 156	N
Cup Wheel 30-31, 209-210	Hawk 90	Nail Puller 152
D	Heavy Duty Scraper 109	Non-Stain Roll Jointer 70
Diamond Blades 194-207	Hopper Gun 96	
Display Stands 232, 239		
Disposable Masks 179, 180		



Notch Trowels	106-107	Screeds	47-48	Brick Trowel.....	68-69
O		Screwdrivers.....	141	Corner Trowel - External.....	86
Open Reel Tape.....	128	Scrub Brush	80	Corner Trowel - Internal.....	84
P		Scutch Combs	157	Coving Trowel	54
Pads (Knee).....	182	Scutch Hammer	123	Fresno Trowel	59
Pencils.....	139-140	Shaping Template	111	Gauging Trowel	68, 107
Pick (Rock).....	119	Shovels.....	168	Margin Trowel.....	69
Plaster Scoop.....	90	Sledge Hammers.....	122	Notch Trowel - Square.....	106-107
Plasterer's Square	87	Small Tools	84	Notch Trowel - V.....	106
Plastic Floats.....	91	Snap Off Knife	144	Plastic Finishing Trowel.....	92
Plastic Trowels.....	92	Spinner Float.....	55	Pointed Finishing Trowel.....	56
Pliers	160-161	Spirit Levels	132-134	Pointing Trowel	64
Plugging Chisel	155	Sponges.....	114	Pool Trowel.....	57
Pointed Finishing Trowel.....	56	Sponge Float – Renderers.....	94	Square Finishing Trowel - Rendering... 92-93	
Pointing Trowel	68	Sponge Floats – Tilers.....	115	Square Front Trowel.....	90, 108
Polystyrene Floats	93	Spoon Jointer.....	70	Tilt Trowel.....	59
Polyurethane Floats.....	90-91	Spot Marking Paint.....	164	Tuck Pointing Trowel	65
Pool Trowels	57	Squares	128, 129	Walking Trowel	59
Profile Clamps.....	75-77	Square Finishing Trowel	57, 93	Walking Brackets	59
Profile Jack.....	78	Square Front Trowel - Tilers	108	Tubular Sealant Gun.....	96, 165-166
Profile Pole.....	79	Square Mouth Shovel.....	168	Tungsten Carbide Grit File	109
Profile Prop	79	Squeegees.....	60		
Pry Bars.....	61, 156	Step Ups	165	U	
R		Straight Edges.....	46	Utility Knives	144-146
Rakes – Aluminium	45	String Lines.....	73		
Ratchet Straps	164	Suction Lifter	111-113	W	
Rebar Bender/Cutter.....	44	T		Walking Trowels.....	59
Reels	42, 126-127, 134-135	T Square	128	Wall Scraper	108-109
Chalk Line Reel	134-135	Tape Measures.....	126-127	Water Brush	95
Fast Retrieval Chalk Line Reel.....	134	Tape Measure Holder.....	173	Wedges.....	106
Tape Measure	126-127	Taping Knives.....	85	Weephole Cleaner	95
Tie Wire Reel.....	42	Telescopic Handle	49	Wet Core Drills	37, 214-218
Replacement Blades.....	64-65	Texture Gun & Parts	96	Wire Twister.....	42
Roller Raker	71-72	Tie Wire Reel.....	42	Wood Chisel	140
Rub Brick.....	61	Tie Wire Twister	42	Wrecking Bar	156-157
Rubber Grouter.....	113	Tile Core Drills.....	38-39	Wrench	160
Rubber Mallets.....	122-123	Tile Nippers.....	104-105		
Rubber Sponge Float	94	Tile Scriber	105		
S		Tile Spacers	106		
Safety Glasses.....	178	Tile Wedges	106		
Safety Gloves	181	Tile Wash Kit.....	115		
Safety Scraper	167	Tilers Levels.....	110		
Saw Horse	165	Timber Float.....	54-55		
Saws	147-149	Toolbags.....	172		
Score & Snap Knife.....	84	Tools Belts.....	174-175		
Scrapers & Replacement Blades		Top Steady Bars	78		
Wall Scraper	108-109	Top Steady Nail-on Clamp	77-78		
Floor Scraper	166-167	Trigger Sprayers.....	169		
Safety Scraper	167	Trim Cutter.....	105		
		Trimming Knives	144, 146		
		Trowels			



Product Code	Page Number	Product Code	Page Number	Product Code	Page Number	Product Code	Page Number	Product Code	Page Number
ENERGYDRINK.....	213	OX-JB10.....	36	OX-P012027.....	87	OX-P015508.....	82	OX-P021530.....	48
ME-DSBB36.....	207	OX-JB13.....	36	OX-P012127.....	87	OX-P015605.....	83	OX-P021536.....	48
ME-DSBF01.....	206	OX-JB25.....	36	OX-P012135.....	87	OX-P015712.....	57	OX-P021612.....	46
ME-DSBF02.....	206	OX-JB26.....	36	OX-P012142.....	87	OX-P015714.....	57	OX-P021615.....	46
ME-DSBH01.....	210	OX-JBA12.....	36	OX-P012144.....	87	OX-P015718.....	57	OX-P021618.....	46
ME-DSBH02.....	210	OX-JBA18.....	36	OX-P012212.....	55	OX-P015722.....	57	OX-P021621.....	46
ME-DSBP01.....	206	OX-JBA58.....	36	OX-P012215.....	55	OX-P015818.....	57	OX-P021624.....	46
ME-DSBP02.....	206	OX-JM01.....	36	OX-P012218.....	55	OX-P016201.....	59	OX-P021627.....	46
ME-DSBT36.....	207	OX-JM03.....	36	OX-P012318.....	55	OX-P016202.....	59	OX-P021630.....	46
ME-DSCO36.....	208	OX-JN20.....	37	OX-P012324.....	55	OX-P016203.....	59	OX-P021636.....	46
ME-DSCR36.....	209	OX-JN25.....	37	OX-P012510.....	51	OX-P016204.....	59	OX-P021712.....	46
ME-DSHB36.....	208	OX-JN30.....	37	OX-P012718.....	89	OX-P016302.....	45	OX-P021715.....	46
ME-DSHH01.....	210	OX-JN55.....	37	OX-P012814.....	89	OX-P016303.....	45	OX-P021718.....	46
ME-DSHH02.....	210	OX-JN56.....	37	OX-P012818.....	89	OX-P016406.....	49	OX-P021721.....	46
ME-DSKB36.....	207	OX-JN65.....	37	OX-P012927.....	111	OX-P016409.....	49	OX-P021724.....	46
ME-DSMS04.....	211	OX-JN66.....	37	OX-P013001.....	80	OX-P016412.....	49	OX-P021727.....	46
ME-DSMS36.....	208	OX-JNHAD3.....	37	OX-P013203.....	81	OX-P016415.....	49	OX-P021730.....	46
ME-DSPE40.....	206	OX-JP35.....	38	OX-P013205.....	81	OX-P016418.....	49	OX-P021736.....	46
ME-DSPO36.....	209	OX-JS01.....	36	OX-P013207.....	81	OX-P016524.....	49	OX-P021901.....	48
ME-DSRP30.....	210	OX-JS03.....	36	OX-P013210.....	81	OX-P016550.....	49	OX-P021902.....	48
ME-DSSB35.....	207	OX-JS03-13.....	36	OX-P013212.....	81	OX-P016606.....	48	OX-P021904.....	48
ME-DSSB45.....	207	OX-JS25.....	36	OX-P013215.....	81	OX-P016609.....	48	OX-P021905.....	48
ME-DSSH00.....	208	OX-JX01.....	36	OX-P013320.....	81	OX-P016612.....	48	OX-P021906.....	48
ME-DSSH01.....	209	OX-JX03.....	36	OX-P013325.....	81	OX-P016615.....	48	OX-P021907.....	48
ME-DSSS36.....	208	OX-JX03-13.....	36	OX-P013330.....	81	OX-P016618.....	48	OX-P023110.....	106
OX-04MPS.....	17	OX-JX15.....	36	OX-P013406.....	103	OX-P017012.....	56	OX-P023112.....	106
OX-05MPS.....	17	OX-JX25.....	36	OX-P013408.....	103	OX-P017016.....	56	OX-P023115.....	106
OX-06MPS.....	17	OX-JX31.....	36	OX-P013410.....	103	OX-P017020.....	56	OX-P023118.....	106
OX-07MPS.....	17	OX-LCO-12.....	19	OX-P013412.....	103	OX-P019020.....	50	OX-P023120.....	106
OX-08MPS.....	17	OX-LCO-14.....	19	OX-P013416.....	65	OX-P019024.....	50	OX-P023201.....	83
OX-09MPS.....	17	OX-LCO-16.....	19	OX-P013418.....	65	OX-P019101.....	50	OX-P024406.....	126
OX-10MPS.....	17	OX-P010113.....	80	OX-P013514.....	58	OX-P019102.....	50	OX-P024408.....	126
OX-12MPSS.....	17	OX-P010116.....	80	OX-P013606.....	64	OX-P019312.....	54	OX-P024409.....	126
OX-14MPS.....	17	OX-P010119.....	80	OX-P013718.....	86	OX-P019501.....	49	OX-P024410.....	126
OX-14MPSS.....	17	OX-P010125.....	80	OX-P013720.....	86	OX-P019710.....	49	OX-P024412.....	126
OX-16MPSS.....	17	OX-P010208.....	87	OX-P013910.....	55	OX-P019813.....	90	OX-P024418.....	126
OX-45MPS.....	17	OX-P010212.....	87	OX-P013916.....	55	OX-P019912.....	90	OX-P024420.....	126
OX-AFT120.....	201	OX-P010214.....	87	OX-P013938.....	55	OX-P019914.....	90	OX-P024424.....	126
OX-AFT180.....	201	OX-P010218.....	87	OX-P014012.....	90	OX-P020108.....	122	OX-P027210.....	127
OX-AFT240.....	201	OX-P010220.....	87	OX-P014014.....	90	OX-P020330.....	129	OX-P027730.....	128
OX-AFT300.....	201	OX-P010222.....	87	OX-P014112.....	55	OX-P020410.....	107	OX-P029601.....	49
OX-AFT360.....	201	OX-P010312.....	64	OX-P014114.....	55	OX-P020730.....	128	OX-P029801.....	46
OX-AFT420.....	201	OX-P010512.....	86	OX-P014210.....	51	OX-P020830.....	128	OX-P029802.....	46
OX-AFT480.....	201	OX-P010513.....	86	OX-P014219.....	51	OX-P021064.....	123	OX-P030115.....	67
OXBOOK2015E4.....	213	OX-P010611.....	88	OX-P014312.....	51	OX-P021114.....	123	OX-P030210.....	66
OX-D310115.....	209	OX-P010718.....	86	OX-P014320.....	51	OX-P021203.....	106	OX-P030212.....	66
OX-D310130.....	209	OX-P010830.....	90	OX-P014406.....	53	OX-P021204.....	106	OX-P030310.....	66
OX-DC10-14.....	16	OX-P010908.....	89	OX-P014410.....	53	OX-P021206.....	106	OX-P030312.....	66
OX-DC10-16.....	16	OX-P010911.....	89	OX-P014506.....	53	OX-P021208.....	106	OX-P030316.....	66
OX-DC10-4.....	16	OX-P010914.....	89	OX-P014510.....	53	OX-P021210.....	106	OX-P030501.....	67
OX-DC10-4.5.....	16	OX-P010916.....	89	OX-P014519.....	53	OX-P021312.....	47	OX-P030602.....	67
OX-DC10-5.....	16	OX-P010918.....	89	OX-P014601.....	57	OX-P021315.....	47	OX-P030703.....	67
OX-DC10-6.....	16	OX-P010995.....	89	OX-P014609.....	57	OX-P021318.....	47	OX-P030813.....	66
OX-DC10-7.....	16	OX-P011008.....	89	OX-P014665.....	57	OX-P021321.....	47	OX-P030816.....	66
OX-DC10-8.....	16	OX-P011011.....	89	OX-P014691.....	57	OX-P021324.....	47	OX-P030819.....	66
OX-DC10-9.....	16	OX-P011014.....	89	OX-P014692.....	57	OX-P021327.....	47	OX-P030822.....	66
OX-DC7-14.....	16	OX-P011016.....	89	OX-P014693.....	57	OX-P021330.....	47	OX-P031003.....	68
OX-DC7-4.5.....	16	OX-P011018.....	89	OX-P014702.....	58	OX-P021336.....	47	OX-P031209.....	66
OX-DC7-5.....	16	OX-P011095.....	89	OX-P014773.....	58	OX-P021412.....	47	OX-P039801.....	68
OX-DC7-6.....	16	OX-P011111.....	65	OX-P014781.....	58	OX-P021415.....	47	OX-P040109.....	165
OX-DC7-7.....	16	OX-P011112.....	65	OX-P014812.....	53	OX-P021418.....	47	OX-P040211.....	165
OX-DC7-8.....	16	OX-P011212.....	65	OX-P014820.....	53	OX-P021421.....	47	OX-P040215.....	165
OX-DS450114.....	210	OX-P011307.....	64	OX-P014825.....	53	OX-P021424.....	47	OX-P049703.....	92
OX-DS450132.....	210	OX-P011308.....	64	OX-P014910.....	53	OX-P021427.....	47	OX-P049704.....	92
OX-DS450158.....	210	OX-P011407.....	103	OX-P014912.....	53	OX-P021430.....	47	OX-P049705.....	92
OX-DS450205.....	211	OX-P011408.....	103	OX-P014916.....	53	OX-P021436.....	47	OX-P049799.....	92
OX-DSHR03.....	210	OX-P011506.....	65	OX-P014925.....	53	OX-P021442.....	47	OX-P049801.....	165
OX-DU10-4.....	16	OX-P011508.....	65	OX-P015010.....	54	OX-P021448.....	47	OX-P049801B.....	165
OX-DU10-4.5.....	16	OX-P011510.....	65	OX-P015110.....	54	OX-P021512.....	48	OX-P049802.....	165
OX-DU10-5.....	16	OX-P011512.....	65	OX-P015204.....	83	OX-P021515.....	48	OX-P049803.....	165
OX-DU10-9.....	16	OX-P011611.....	88	OX-P015206.....	83	OX-P021518.....	48	OX-P049804.....	165
OX-JB04.....	36	OX-P011812.....	109	OX-P015305.....	82	OX-P021521.....	48	OX-P050105.....	105
OX-JB05.....	36	OX-P011895.....	109	OX-P015408.....	82	OX-P021524.....	48	OX-P050208.....	166
OX-JB09.....	36	OX-P011995.....	109	OX-P015505.....	82	OX-P021527.....	48	OX-P050314.....	166



SKU Index cont...

Product Code	Page Number	Product Code	Page Number	Product Code	Page Number	Product Code	Page Number	Product Code	Page Number
OX-P050408	167	OX-P101140	72	OX-P201206	132	OX-P335675	165	OX-PCTT-4	30
OX-P050609	167	OX-P101213	72	OX-P201212	132	OX-P360110	135	OX-PCTT-5	30
OX-P050909	167	OX-P101222	72	OX-P201218	132	OX-P362027	135	OX-PCTT-7	30
OX-P059608	167	OX-P101502	70	OX-P201224	132	OX-P362007	135	OX-PDC-022	35
OX-P059714	166	OX-P101716	72	OX-P201236	132	OX-P362107	135	OX-PDC-028	35
OX-P059808	166	OX-P101801	70	OX-P21SET7	106	OX-P370105	134	OX-PDC-032	35
OX-P059905	105	OX-P102007	71	OX-P220102	80	OX-P370406	134	OX-PDC-038	35
OX-P060104	91	OX-P102012	71	OX-P220208	101	OX-P370410	134	OX-PDC-048	35
OX-P060105	91	OX-P102114	73	OX-P220601	138	OX-P370413	134	OX-PDC-052	35
OX-P060207	77	OX-P102201	71	OX-P220801	139	OX-P370416	134	OX-PDC-065	35
OX-P060390	60	OX-P102310	74	OX-P220901	138	OX-P370419	134	OX-PDC-078	35
OX-P070455	105	OX-P102432	74	OX-P221001	138	OX-P370422	134	OX-PDC-091	35
OX-P071008	61	OX-P109901	72	OX-P221101	139	OX-P370425	134	OX-PDC-102	35
OX-P071106	61	OX-P110215	168	OX-P221510	138	OX-P370432	134	OX-PDC-107	35
OX-P080116	114	OX-P110610	168	OX-P222010	139	OX-P370438	134	OX-PDC-117	35
OX-P080120	114	OX-P110615	168	OX-P222110	139	OX-P400416	56	OX-PDC-127	35
OX-P080124	114	OX-P110640	168	OX-P230118	44	OX-P400517	56	OX-PDC-142	35
OX-P080204	118	OX-P120220	97	OX-P230124	44	OX-P402414	90	OX-PDC-152	35
OX-P080207	118	OX-P120308	96	OX-P230130	44	OX-P402514	90	OX-PDC-158	35
OX-P080210	118	OX-P120312	96	OX-P230136	44	OX-P402760	58	OX-PDC-162	35
OX-P080214	118	OX-P120435	97	OX-P230142	44	OX-P402790	58	OX-PDC-172	35
OX-P080325	117	OX-P120512	97	OX-P230231	42	OX-P402860	59	OX-PDC-182	35
OX-P080425	116	OX-P120535	97	OX-P230322	42	OX-P402890	59	OX-PDD-05	38
OX-P080522	119	OX-P120609	96	OX-P230325	42	OX-P402960	59	OX-PDD-06	38
OX-P080528	119	OX-P120612	96	OX-P230328	42	OX-P402990	59	OX-PDD-07	38
OX-P080605	118	OX-P120735	96	OX-P230418	43	OX-P404814	111	OX-PDD-08	38
OX-P080610	118	OX-P120809	96	OX-P230420	43	OX-PA10-14	19	OX-PDD-10	38
OX-P080725	149	OX-P120909	96	OX-P230518	44	OX-PA10-16	19	OX-PDD-12	38
OX-P080725B	149	OX-P120913	96	OX-P230520	43	OX-PAF-16	26	OX-PDD-15	38
OX-P080738	149	OX-P121012	96	OX-P230524	44	OX-PAF-18	26	OX-PDD-20	38
OX-P080738B	149	OX-P121035	96	OX-P230530	44	OX-PAF-20	26	OX-PDD-25	38
OX-P080750	149	OX-P121414	97	OX-P230536	44	OX-PAF-24	26	OX-PDD-35	38
OX-P080750B	149	OX-P121515	97	OX-P231001	141	OX-PB10-14	19	OX-PHB-14	23
OX-P081620	115	OX-P130201	104	OX-P231002	141	OX-PB10-16	19	OX-PHB-16	23
OX-P082328	114	OX-P130730	140	OX-P231003	141	OX-PB10-4	19	OX-PHBS-14	24
OX-P082424	114	OX-P130815	140	OX-P239930	44	OX-PB10-4.5	19	OX-PHBS-16	24
OX-P082614	115	OX-P131318	140	OX-P239936	44	OX-PB10-5	19	OX-PLA600	200
OX-P082703	116	OX-P131324	140	OX-P239942	44	OX-PB10-6	19	OX-PLA900	200
OX-P082704	116	OX-P131332	140	OX-P250113	110	OX-PB10-7	19	OX-PMR-4	29
OX-P083010	144	OX-P131424	140	OX-P250215	111	OX-PB10-8	19	OX-PMR-4.5	29
OX-P083012	144	OX-P132016	141	OX-P250311	110	OX-PB10-9	19	OX-PMR-5	29
OX-P083110	144	OX-P133034	141	OX-P250313	110	OX-PBF-16	26	OX-PMR-7	29
OX-P083222	115	OX-P139801	104	OX-P250411	110	OX-PBF-18	26	OX-PMT-4	33
OX-P083524	149	OX-P151180	100	OX-P250413	110	OX-PBF-20	26	OX-PMT-4.5	33
OX-P090210	148	OX-P151185	100	OX-P250691	60	OX-PBF-24	26	OX-PMT-5	33
OX-P090310	149	OX-P151280	100	OX-P250791	60	OX-PC100	179	OX-PMT-6	33
OX-P090315	149	OX-P151285	100	OX-P260118	172	OX-PC60	178	OX-PMT-7	33
OX-P090422	146	OX-P151385	101	OX-P260501	173	OX-PCB-14	23	OX-PMT-8	33
OX-P090503	146	OX-P152180	100	OX-P260502	173	OX-PCB-16	23	OX-PMT-9	33
OX-P090545	146	OX-P152280	100	OX-P260503	173	OX-PCB-18	23	OX-PMTV-4.5	33
OX-P092002	145	OX-P152475	101	OX-P260504	174	OX-PCB-20	23	OXPOS-BIS01	212
OX-P092103	145	OX-P170350	75	OX-P260505	174	OX-PCBS-14	24	OXPOS-BIS02	212
OX-P092303	145	OX-P170403	107	OX-P260701	174	OX-PCBS-16	24	OXPOS-BIS03	212
OX-P092401	145	OX-P170504	107	OX-P260702	174	OX-PCBS-18	24	OXPOS-CAP01	212
OX-P092501	147	OX-P170524	108	OX-P260703	174	OX-PCBS-20	24	OXPOS-CAP02	212
OX-P092856	148	OX-P170534	108	OX-P260704	175	OX-PCC-5	35	OXPOS-LEVEL1	211
OX-P093015	148	OX-P170708	109	OX-P260705	175	OX-PCD-185	32	OXPOS-POLOL	213
OX-P100101	70	OX-P170808	108	OX-P260736	175	OX-PCD-230	32	OXPOS-POLOM	213
OX-P100101B	70	OX-P190212	76	OX-P260740	175	OX-PCF-16	26	OXPOS-POLOS	213
OX-P100215	68	OX-P199903	76	OX-P261645	172	OX-PCF-18	26	OXPOS-POLOXL	213
OX-P100215B	68	OX-P200101	133	OX-P261747	172	OX-PCF-20	26	OXPOS-POLOXL	213
OX-P100302	71	OX-P200506	132	OX-P281	94	OX-PCF-24	26	OX-PSB-14	23
OX-P100307	71	OX-P200512	132	OX-P282	95	OX-PCT-10	28	OX-PSB-16	23
OX-P100312	71	OX-P200518	132	OX-P311710	169	OX-PCT-14	28	OX-PSB-18	23
OX-P100501	75	OX-P200524	132	OX-P311720	169	OX-PCT-4	28	OX-PSB-20	23
OX-P100615	69	OX-P200536	132	OX-P311730	169	OX-PCT-4.5	28	OX-PSBS-14	24
OX-P100615B	69	OX-P200706	133	OX-P320516	152	OX-PCT-5	28	OX-PSBS-16	24
OX-P100715	68	OX-P200712	133	OX-P321318	153	OX-PCT-6	28	OX-PSBS-18	24
OX-P100715B	68	OX-P200718	133	OX-P321620	152	OX-PCT-7	28	OX-PSBS-20	24
OX-P100801	73	OX-P200724	133	OX-P322225	153	OX-PCT-8	28	OX-PSF-16	26
OX-P100950	73	OX-P200736	133	OX-P324506	152	OX-PCT-9	28	OX-PSF-18	26
OX-P101001	74	OX-P200904	164	OX-P324508	152	OX-PCTB-4	30	OX-PSF-20	26
OX-P101002	73	OX-P201006	164	OX-P324510	152	OX-PCTB-5	30	OX-PSF-24	26
OX-P101080	74	OX-P201109	164	OX-P324512	152	OX-PCTB-7	30	OX-PT24	180





Product Code	Page Number	Product Code	Page Number	Product Code	Page Number	Product Code	Page Number	Product Code	Page Number
OX-PT34.....	181	OX-T017393.....	56	OX-T090118.....	147	OX-T330209.....	199	OX-T332630.....	201
OX-PT36.....	182	OX-T017410.....	50	OX-T090502.....	146	OX-T330312.....	199	OX-T332636.....	201
OX-PT36/9.....	182	OX-T017419.....	50	OX-T090945.....	146	OX-T330318.....	199	OX-T332642.....	201
OX-PT40.....	183	OX-T017512.....	50	OX-T091012.....	148	OX-T330403.....	201	OX-T332648.....	201
OX-PT40/9.....	183	OX-T017520.....	50	OX-T091018.....	148	OX-T330704.....	194	OX-T335001.....	195
OX-PT46/13.....	184	OX-T020108.....	122	OX-T091024.....	148	OX-T330706.....	194	OX-T335101.....	195
OX-PT46/9.....	184	OX-T020110.....	122	OX-T091030.....	148	OX-T330707.....	194	OX-T335201.....	195
OX-S240102.....	160	OX-T022501.....	164	OX-T091036.....	148	OX-T330708.....	194	OX-T401704.....	102
OX-S240210.....	157	OX-T022502.....	164	OX-T091106.....	147	OX-T330902.....	193	OX-T401706.....	102
OX-S240220.....	157	OX-T022503.....	164	OX-T091206.....	147	OX-T330903.....	193	OX-T401708.....	102
OX-S240230.....	157	OX-T022504.....	164	OX-T091208.....	147	OX-T330904.....	193	OX-T401710.....	102
OX-S240402.....	156	OX-T022505.....	164	OX-T091210.....	147	OX-T330906.....	193	OX-T401712.....	102
OX-S240605.....	157	OX-T022506.....	164	OX-T091212.....	147	OX-T331004.....	194	OX-T401804.....	102
OX-S240620.....	157	OX-T022507.....	164	OX-T091218.....	147	OX-T331006.....	194	OX-T401806.....	102
OX-S240702.....	157	OX-T022910.....	133	OX-T091445.....	146	OX-T331007.....	194	OX-T401808.....	102
OX-S240810.....	157	OX-T022972.....	134	OX-T101601.....	70	OX-T331008.....	194	OX-T401810.....	102
OX-S240903.....	158	OX-T023010.....	133	OX-T102805.....	69	OX-T331102.....	195	OX-T401812.....	102
OX-S240910.....	158	OX-T023072.....	134	OX-T102810.....	69	OX-T331103.....	195	OX-T403104.....	103
OX-S241009.....	159	OX-T023503.....	123	OX-T102905.....	69	OX-T331104.....	195	OX-T403106.....	103
OX-S241010.....	159	OX-T023505.....	123	OX-T102910.....	69	OX-T331105.....	195	OX-T403108.....	103
OX-S241109.....	159	OX-T023510.....	123	OX-T103005.....	69	OX-T331106.....	195	OX-T403110.....	103
OX-S241110.....	159	OX-T024701.....	129	OX-T103010.....	69	OX-T331107.....	195	OX-TA10-14.....	17
OX-S242006.....	160	OX-T024702.....	129	OX-T103105.....	69	OX-T331108.....	195	OX-TB10-14.....	17
OX-S242010.....	160	OX-T024703.....	129	OX-T103110.....	69	OX-T331109.....	195	OX-TB10-16.....	17
OX-S242110.....	157	OX-T024704.....	129	OX-T103205.....	69	OX-T331202.....	193	OX-TB10-4.....	17
OX-S242150.....	157	OX-T024705.....	129	OX-T103210.....	69	OX-T331203.....	193	OX-TB10-4.5.....	17
OX-S242212.....	158	OX-T024706.....	129	OX-T151010.....	101	OX-T331204.....	193	OX-TB10-5.....	17
OX-S242407.....	160	OX-T025001.....	129	OX-T160902.....	102	OX-T331205.....	193	OX-TB10-6.....	17
OX-S242408.....	160	OX-T025002.....	129	OX-T160903.....	102	OX-T331206.....	193	OX-TB10-7.....	17
OX-S242409.....	160	OX-T025003.....	129	OX-T160905.....	102	OX-T331207.....	193	OX-TB10-8.....	17
OX-S242410.....	160	OX-T025004.....	129	OX-T181401.....	185	OX-T331208.....	193	OX-TB10-9.....	17
OX-S242411.....	160	OX-T025007.....	129	OX-T181402.....	185	OX-T331309.....	196	OX-TC10-12.....	17
OX-S242412.....	160	OX-T025008.....	129	OX-T181403.....	185	OX-T331310.....	196	OX-TC10-14.....	17
OX-S242413.....	160	OX-T025009.....	129	OX-T181404.....	185	OX-T331311.....	196	OX-TC10-16.....	17
OX-S243010.....	161	OX-T025010.....	129	OX-T181405.....	185	OX-T331313.....	196	OX-TC10-4.....	17
OX-S243110.....	161	OX-T025013.....	129	OX-T181406.....	186	OX-T331409.....	196	OX-TC10-4.5.....	17
OX-S243210.....	161	OX-T025014.....	129	OX-T181407.....	186	OX-T331410.....	196	OX-TC10-5.....	17
OX-S243310.....	161	OX-T030401.....	91	OX-T181408.....	186	OX-T331411.....	196	OX-TC10-6.....	17
OX-S243410.....	161	OX-T040215.....	92	OX-T181409.....	186	OX-T331412.....	196	OX-TC10-7.....	17
OX-S246120.....	158	OX-T040308.....	92	OX-T181410.....	186	OX-T331413.....	196	OX-TC10-8.....	17
OX-S246412.....	158	OX-T042005.....	168	OX-T182124.....	187	OX-T331703.....	193	OX-TC10-9.....	17
OX-S481310.....	159	OX-T042010.....	168	OX-T182136.....	187	OX-T331704.....	193	OX-TCB-14.....	22
OX-S481410.....	159	OX-T050508.....	166	OX-T189124.....	189	OX-T331803.....	197	OX-TCB-16.....	22
OX-T010212.....	86	OX-T050512.....	166	OX-T189134.....	189	OX-T331804.....	197	OX-TCT-10.....	28
OX-T010214.....	86	OX-T050514.....	166	OX-T189136.....	189	OX-T331806.....	197	OX-TCT-14.....	28
OX-T010218.....	86	OX-T050520.....	166	OX-T189146.....	189	OX-T331808.....	197	OX-TCT-4.....	28
OX-T010220.....	86	OX-T050604.....	104	OX-T189424.....	189	OX-T331810.....	197	OX-TCT-4.5.....	28
OX-T010911.....	88	OX-T050606.....	104	OX-T189434.....	189	OX-T331812.....	197	OX-TCT-5.....	28
OX-T010914.....	88	OX-T059408.....	166	OX-T189436.....	189	OX-T331906.....	197	OX-TCT-6.....	28
OX-T011407.....	64	OX-T059412.....	166	OX-T189440.....	189	OX-T331907.....	197	OX-TCT-7.....	28
OX-T016301.....	45	OX-T059414.....	166	OX-T189446.....	189	OX-T331908.....	197	OX-TCT-8.....	28
OX-T016805.....	51	OX-T059420.....	166	OX-T189501.....	187	OX-T332009.....	198	OX-TCT-9.....	28
OX-T016806.....	51	OX-T059504.....	104	OX-T189504.....	188	OX-T332010.....	198	OX-THB-14.....	22
OX-T016810.....	51	OX-T059506.....	104	OX-T189506.....	188	OX-T332011.....	198	OX-THB-16.....	22
OX-T016819.....	51	OX-T060401.....	77	OX-T189507.....	188	OX-T332012.....	198	OX-TMR-4.....	29
OX-T016906.....	52	OX-T060601.....	77	OX-T189508.....	188	OX-T332013.....	198	OX-TMR-4.5.....	29
OX-T016910.....	52	OX-T060701.....	77	OX-T189624.....	187	OX-T332103.....	197	OX-TMR-5.....	29
OX-T017012.....	52	OX-T060801.....	91	OX-T189634.....	187	OX-T332104.....	197	OX-TMR-7.....	29
OX-T017020.....	52	OX-T060802.....	91	OX-T189636.....	187	OX-T332105.....	197	OX-TSB-14.....	22
OX-T017025.....	52	OX-T061001.....	76	OX-T189646.....	187	OX-T332106.....	197	OX-TSB-16.....	22
OX-T017102.....	54	OX-T070601.....	81	OX-T220601.....	138	OX-T332107.....	197	OX-TTD-06.....	38
OX-T017112.....	52	OX-T080920.....	116	OX-T230231.....	42	OX-T332108.....	197	OX-TTD-08.....	38
OX-T017115.....	54	OX-T081024.....	115	OX-T230401.....	139	OX-T332109.....	197	OX-TTD-10.....	38
OX-T017118.....	54	OX-T081303.....	117	OX-T230613.....	44	OX-T332208.....	198	OX-TTD-100.....	38
OX-T017124.....	54	OX-T081304.....	117	OX-T240300.....	61	OX-T332210.....	198	OX-TTD-110.....	38
OX-T017125.....	52	OX-T081507.....	118	OX-T280107.....	167	OX-T332212.....	198	OX-TTD-115.....	38
OX-T017210.....	52	OX-T081510.....	118	OX-T280109.....	167	OX-T332214.....	198	OX-TTD-120.....	38
OX-T017211.....	88	OX-T081512.....	118	OX-T280212.....	167	OX-T332216.....	198	OX-TTD-13.....	38
OX-T017214.....	88	OX-T081514.....	118	OX-T299701.....	42	OX-T332303.....	195	OX-TTD-18.....	38
OX-T017301.....	56	OX-T081724.....	119	OX-T330109.....	200	OX-T332304.....	195	OX-TTD-20.....	38
OX-T017309.....	56	OX-T081732.....	119	OX-T330112.....	200	OX-T332305.....	195	OX-TTD-25.....	38
OX-T017365.....	56	OX-T082004.....	117	OX-T330115.....	200	OX-T332612.....	201	OX-TTD-27.....	38
OX-T017391.....	56	OX-T090110.....	147	OX-T330118.....	200	OX-T332618.....	201	OX-TTD-30.....	38
OX-T017392.....	56	OX-T090112.....	147	OX-T330206.....	199	OX-T332624.....	201	OX-TTD-32.....	38



Product Code	Page Number		
OX-TTD-36	38	OX-UCGT-4.5	30
OX-TTD-45	38	OX-UCGT-5	30
OX-TTD-51	38	OX-UCGT-7	30
OX-TTD-54	38	OX-UCT-10	28
OX-TTD-63	38	OX-UCT-14	28
OX-TTD-67	38	OX-UCT-4	28
OX-TTD-73	38	OX-UCT-4.5	28
OX-TTD-83	38	OX-UCT-5	28
OX-TTD-86	38	OX-UCT-6	28
OX-TTD-90	38	OX-UCT-7	28
OX-TTD-95	38	OX-UCT-8	28
OX-TU10-14	17	OX-UCT-9	28
OX-TU10-4	17	OX-UCTT-10	28
OX-TU10-4.5	17	OX-UCTT-14	28
OX-TU10-5	17	OX-UCTT-4	28
OX-TU10-6	17	OX-UCTT-4.5	28
OX-TU10-7	17	OX-UCTT-5	28
OX-TU10-8	17	OX-UCTT-6	28
OX-TU10-9	17	OX-UCTT-7	28
OX-TUB-14	22	OX-UCTT-8	28
OX-TUB-16	22	OX-UCTT-9	28
OX-U230322	43	OX-UKB-14	31
OX-U230325	43	OX-UKB-16	31
OX-U230328	43	OX-UKB-4	31
OX-U230418	43	OX-UKB-5	31
OX-U230420	43	OX-UKB-7	31
OX-UA10-14	20	OX-UKB-9	31
OX-UA10-16	20	OX-UMB-14	33
OX-UAF-16	27	OX-UMB-16	33
OX-UAF-18	27	OX-UMR-4.5	29
OX-UAF-20	27	OX-UMR-5	29
OX-UAF-24	27	OX-UMR-7	29
OX-UB10-14	20	OX-UTDH-06	39
OX-UB10-16	20	OX-UTDH-08	39
OX-UB10-4	20	OX-UTDH-10	39
OX-UB10-4.5	20	OX-UTDH-102	39
OX-UB10-5	20	OX-UTDH-107	39
OX-UB10-6	20	OX-UTDH-112	39
OX-UB10-7	20	OX-UTDH-117	39
OX-UB10-8	20	OX-UTDH-12	39
OX-UB10-9	20	OX-UTDH-122	39
OX-UBF-16	27	OX-UTDH-16	39
OX-UBF-18	27	OX-UTDH-18	39
OX-UBF-20	27	OX-UTDH-20	39
OX-UBF-24	27	OX-UTDH-22	39
OX-UC10-14	20	OX-UTDH-25	39
OX-UC10-16	20	OX-UTDH-28	39
OX-UC10-4	20	OX-UTDH-30	39
OX-UC10-4.5	20	OX-UTDH-32	39
OX-UC10-5	20	OX-UTDH-36	39
OX-UC10-6	20	OX-UTDH-40	39
OX-UC10-7	20	OX-UTDH-45	39
OX-UC10-8	20	OX-UTDH-52	39
OX-UC10-9	20	OX-UTDH-56	39
OX-UCC-5	36	OX-UTDH-62	39
OX-UCDB-4	30	OX-UTDH-65	39
OX-UCDB-4.5	30	OX-UTDH-72	39
OX-UCDB-5	30	OX-UTDH-76	39
OX-UCDB-6	30	OX-UTDH-82	39
OX-UCDB-7	30	OX-UTDH-87	39
OX-UCDT-4	30	OX-UTDH-92	39
OX-UCDT-4.5	30	OX-UTDT-06	39
OX-UCDT-5	30	OX-UTDT-08	39
OX-UCDT-6	30	OX-UTDT-10	39
OX-UCDT-7	30	OX-UTDT-102	39
OX-UCF-16	27	OX-UTDT-107	39
OX-UCF-18	27	OX-UTDT-112	39
OX-UCF-20	27	OX-UTDT-117	39
OX-UCF-24	27	OX-UTDT-12	39
OX-UCGB-4	30	OX-UTDT-122	39
OX-UCGB-4.5	30	OX-UTDT-16	39
OX-UCGB-5	30	OX-UTDT-20	39
OX-UCGB-7	30	OX-UTDT-22	39
OX-UCGT-4	30	OX-UTDT-25	39
		OX-UTDT-28	39
		OX-UTDT-30	39
		OX-UTDT-32	39
		OX-UTDT-36	39
		OX-UTDT-40	39
		OX-UTDT-45	39
		OX-UTDT-52	39
		OX-UTDT-56	39
		OX-UTDT-62	39
		OX-UTDT-65	39
		OX-UTDT-72	39
		OX-UTDT-76	39
		OX-UTDT-82	39
		OX-UTDT-87	39
		OX-UTDT-92	39
		OX-UU10-14	20
		OX-UU10-16	20
		OX-UU10-9	20
		OX-UWC014-450	37
		OX-UWC016-450	37
		OX-UWC018-450	37
		OX-UWC020-450	37
		OX-UWC022-450	37
		OX-UWC024-450	37
		OX-UWC025-450	37
		OX-UWC028-450	37
		OX-UWC030-450	37
		OX-UWC032-450	37
		OX-UWC036-450	37
		OX-UWC040-450	37
		OX-UWC045-450	37
		OX-UWC052-450	37
		OX-UWC056-450	37
		OX-UWC062-450	37
		OX-UWC065-450	37
		OX-UWC072-450	37
		OX-UWC076-450	37
		OX-UWC082-450	37
		OX-UWC087-450	37
		OX-UWC092-450	37
		OX-UWC102-450	37
		OX-UWC107-450	37
		OX-UWC112-450	37
		OX-UWC117-450	37
		OX-UWC122-450	37
		OX-UWC127-450	37
		OX-UWC132-450	37
		OX-UWC142-450	37
		OX-UWC152-450	37
		OX-UWC162-450	37
		OX-UWC172-450	37
		OX-UWC182-450	37
		OX-UWC200-450	37
		OX-UWC225-450	37
		OX-UWC250-450	37
		OX-UWC300-450	37
		OX-UWC350-450	37
		OX-UWC400-450	37



FAQ's

Answers

- Can I get a product on an urgent airbag?** Yes we can freight product in an airbag overnight. There will be a \$25 fee and the order needs to be booked before 10.30am AEST and be within 5kg weight and 40cm.
- Can I pick up my order from the warehouse?** Orders can be picked up from the warehouse. There will be a \$25 fee and an order reference number must be obtained from Customer Service before collection. 2 hours notice must be given.
- Can I place an order without an account?** An account application must be completed and approved as a qualified distributor before placing orders.
- Could I please apply for an account.** Email the Customer Service Team at sales@oxgroup.com.au for an account application form.
- How long will it take for my account to be opened?** Once application has been submitted, applicant will be contacted within 5 business days in view of account being opened within 10 business days.
- Does OX Group have a online shop?** At this time, we do not have an online tool store.
- Do you provide your pricelist in an excel version?** Yes. Please contact customer service at sales@oxgroup.com.au to receive a copy.
- Do you accept Amex?** Mastercard & Visa are our accepted credit card methods.
- Is there a surcharge if I pay via credit card?** Credit card payments incur no surcharge.
- Do you have a minimum order value?** \$50 is minimum order value.
- Do you offer same day dispatch?** All orders placed by 3:00pm AEST will be dispatched the same day
- Do you still have a 1300 number?** The original Core Supplies & Duroline 1300 numbers have been superceded with **02 8845 6600**
- Does OX sell to the public** OX only sells to authorised distributors, these distributors can be located via our website
- How long has the OX brand been around?** Our tool range was born in 1974 in Perth, Australia and was launched under the OX brand at the beginning of 2010.
- Is this the same company as Duroline? Puraclene? Core Supplies?** Duroline, Puraclene, Core Supplies merged to form OX Group International in 2010.
- What are the pack qty's?** All pack quantities are listed in this catalogue before the list price
- What category do you specialise in?** OX Group has 40 years of experience in the masonry hand tool market and has recently expanded into multiple categories in the construction industry
- What is my reps mobile number?** Please call 02 8845 6600 for your reps mobile number.
- What is our minimum order value for FIS?** \$250 Net
- What is the freight charge under FIS?** \$19.90. This excludes access product. Contact our Customer Service Team for a price for freight costs on our access range.
- What is your returns policy?** "At OX, we have a sale or return policy. If you cannot sell an OX brand product within 3 months of purchase, simply return it in a suitable condition for a full refund"
- How long will it take to freight?** See below graph of freight transit times*.

Destination	Days truck leaves SYD	Lead time	Destination	Days truck leaves SYD	Lead time
Adelaide	Daily	2 working days	Karratha	Daily via Perth	2-3 working days
Albury	Daily	Next working day	Melbourne	Daily	Next working day
Alice Springs	Daily via Adelaide	4 working days	Mt Isa	Daily via Brisbane	5-6 working days
Brisbane	Daily	Next working day	Orange	Daily	Next working day
Bundaberg	Daily via Brisbane	2 working days	Perth	Daily	Next working day
Cairns	Daily via Brisbane	3 working days	Sydney	Daily	Next working day
Canberra	Daily	Next working day	Townsville	Daily via Brisbane	3 working days
Nowra	Daily	Next working day	Winnellie	Daily via Adelaide	5 working days
Darwin	Daily via Adelaide	5 working days	Newcastle	Daily	Next working day
Devonport	Daily via Melbourne	4-5 working days	Riverina	Daily to Wagga depot	Dependant on delivery town
Hobart	Daily via Melbourne	4-5 working days			

* All lead times are estimated lead times only.



Terms and Conditions

1. INTERPRETATION

- (a) 'Contract' means the standard trading terms and conditions of sale (which applies to each and every Quotation and/or Order) and includes any Quotation and Order
- (b) 'OX Group' means (DO NO. 2)
- (c) 'Customer' means the entity to which 'OX Group' enters into a Contract for the sale of Goods.
- (d) 'Goods' means the goods described in the Quotation or Order and includes replacement goods.
- (e) 'Order' means a written or verbal order from the Customer to OX Group.
- (f) 'Quotation' means a written or verbal quotation provided by OX Group to the Customer.

2. ORDERS

- (a) Orders for Goods will be binding upon OX Group and the Customer. However, OX Group reserves the right to accept orders in whole or in part.
- (b) Once OX Group has accepted an Order, the customer may not alter or modify the Order without the prior written consent of OX Group.
- (c) 15% Re-stocking fee applies to all returned products providing they are in re-saleable condition.

3. PRICES

- (a) All prices contained in the Quotation and/or Order will be exclusive of GST. All prices are in Australian dollars and subject to alteration without notice. All invoices are in Australian dollars and must be settled in Australian dollars.
- (b) Any order placed with a value of under \$50.00 excluding GST will not be processed. This minimum invoice value does not apply to back-orders.
- (c) Handling fee of \$1.95 will be applied to the total of every invoice, excluding back-orders
- (d) Orders with an invoice value of over \$300.00 excluding GST will be shipped free in-store
- (e) Orders with an invoice value of over \$300.00 excluding GST will be charged a freight charge of \$17.25. (Freight charges subject to change)

4. PAYMENT AND CREDIT TERMS

- (a) Unless otherwise agreed in writing, the payment due date is strictly thirty, (30) days from the end of the month in which the Goods are purchased.
- (b) Accounts with overdue balances will automatically have credit withdrawn until all outstanding balances are cleared. OX Group reserves the right to charge interest at the rate of 2% on all overdue balances calculated on a daily basis from the due date until such amount is paid.
- (c) If the Customer defaults in payment of any invoice when due, the Customer will indemnify OX Group from and against all OX Group's costs and disbursements including a solicitor and own client basis and in addition to OX Group's nominee's costs of collection.

5. DELIVERY OF GOODS AND RISK

- (a) Delivery of the Goods shall be made to the Customer's address. The Customer shall make all arrangements necessary to take delivery of the Goods whenever they are tendered for delivery.
- (b) The failure of OX Group to deliver will not entitle the Customer to treat this Contract as cancelled.
- (c) OX Group will not be liable for any loss or damage whatever due to failure by OX Group to deliver the Goods (or any part of them) promptly or at all.
- (d) All risk for the Goods passes to the Customer on delivery even if OX Group retains ownership.
- (e) Delivery will be free in store (FIS) Australia wide for Orders in excess of \$300.00 + GST. However, the Customer will be liable delivery charges if a delivery date is required outside of usual delivery times. Orders less than \$300.00 + GST will be subject to the current freight charge of \$9.50. (Freight charges subject to change)

6. RETENTION OF TITLE

- (a) All Goods remain the property of OX Group until the Customer has paid for the Goods in full. If payment is made by cheque, payment will not be deemed to have been made until the cheque has been honoured.

- (b) If the Goods are on-sold by the Customer before payment to OX Group, the proceeds of sale will become property of OX Group.
- (c) If the Goods are not paid for pursuant to clause 4, OX Group may give notice in writing to the Customer to return the Goods or any part of them to OX Group.
- (d) OX Group may enter the Customer's premises without notice at any time and take possession of the Goods and without being responsible for any damage thereby caused if:
 - (i) The Customer does not pay for the Goods under clause 4;
 - (ii) The Customer fails to return the Goods upon demand;
 - (iii) A trustee in bankruptcy, Administrator, or receiver and manager is appointed over the Customer;
 - (iv) Winding-up proceedings in relation to the Customer are commencing; or
 - (v) The Customer becomes bankrupt.

7. CLAIMS

- (a) The Customer will inspect the Goods on delivery and will within seven (7) days of delivery notify OX Group in writing of any alleged defect, shortage in quantity, errors, omissions or failure to comply with the Order or Quotation.
- (b) The Customer will afford OX Group the opportunity to inspect the Goods within a reasonable time of delivery if the Customer believed the Goods are defective in any way. If the Customer fails to comply with these provisions, the Goods will be deemed to be free from any defect or damage and payment will be owing under this Contract.
- (c) If OX Group agrees in writing that the Customer is entitled to reject the Goods because they are defective:
 - (i) The Goods must have a corresponding invoice number quoted;
 - (ii) Freight charges incurred for the return of the Goods being returned is at the expense of the Customer, unless otherwise agreed; and
 - (iii) OX Group's liability is limited to either replacing or repairing the Goods at its discretion.
- (d) OX Group does not warrant that the Goods are fit for any particular purpose or an intended use by the Customer.

8. LIMITATION OF LIABILITY

- (a) Subject to clause 8(b), OX Group will have no liability whatsoever for any direct or indirect losses, expenses, damages and costs incurred by the Customer caused by any breach by OX Group of this Contract or any negligent act or omission.
- (b) The liability of OX Group to the Customer in the event of any breach of this Contract or other cause of action will not exceed the price of the Goods.

9. PRIVACY ACT 1998

- (a) The Customer agrees for OX Group to obtain from a credit-reporting agency and the trade referees a credit report containing personal credit information about the Customer and any additional information required by OX Group.
- (b) OX Group may exchange information about the Customer with those trade referees named in the application form for a trading account or named in a consumer credit report issued by reporting agency to:
 - (i) Assess the Customer's application;
 - (ii) Notify other credit providers of a default by the Customer;
 - (iii) Exchange other information with other credit providers as to the status of the trading account, if the Customer is in default with other credit providers; and
 - (iv) Assess the credit worthiness of the Customer.

10. GENERAL

- (a) If any provision of these terms and conditions becomes void or unenforceable, it will be severed from this agreement without affecting the enforceability of the other provision, which will continue to have full force and effect.
- (b) These terms and conditions are governed by the laws of New South Wales and each party irrevocably and unconditionally submit to the nonexclusive jurisdiction of the courts of New South Wales.
- (c) OX Group may terminate or vary this Contract or cancel delivery of Goods at any time before the Goods are delivered by giving written notice. OX Group will not be liable for

any loss or damage whatever arising from termination or cancellations.

11. PERSONAL PROPERTY SECURITY ACT (PPSA)

- 11.1 The Customer agrees, at the request of OX Group, to enter into a Security Agreement with OX Group to grant in favour of OX Group a Security Interest in all the Customer's present and after acquired property relating to the Goods.
- 11.2 The Customer acknowledges and agrees that it shall, within 14 days of request from OX Group, do all things and sign all documents as required by OX Group to register, confirm or validate the Security Interest created over the Customer's assets by any Security Agreement.
- 11.3 OX Group may exercise its rights under the Security Agreement any time after the Customer fails to comply with this Agreement, without OX Group first having to take any action or enforce any of its other rights against the Customer.
- 11.4 The Customer will be entitled to a release of the Security Agreement when all its obligations under this Agreement have been satisfied.
- 11.5 The Customer shall not without OX Group's prior written consent, which will not be unreasonably withheld, do any of the following:
 - (a) acquire any asset which is, or upon acquisition, will be subject to a Security Interest which is not a Permitted Security Interest; or
 - (b) give any person other than OX Group control or possession of the Goods (other than under a Permitted Security Interest).
- 11.6 The Customer agrees that it will promptly take such action as OX Group may require (including providing information or signing documents) to ensure that any Security interest granted in favour of OX Group attaches to the secured property and to enable OX Group to perfect any such Security Interest or otherwise exercise any rights that it may have under the PPS Law in relation to the secured property.
- 11.7 The Customer acknowledges and agrees that, from the registration commencement time under the PPSA:
 - (a) it shall not cause or permit any person to take a Security Interest over, or to register a financing statement in relation to, any secured property without the prior written consent of OX Group and will immediately notify OX Group if it becomes aware of any person taking steps to register a financing statement in relation to such secured property;
 - (b) it has no rights under, or by reference to, sections 125, 142 and 143 of the PPSA if it defaults and OX Group takes enforcement action under this Agreement in respect of the secured property;
 - (c) it waives its rights to:
 - (i) receive any notice under sections 95, 130 and 135 of the PPSA in relation to the enforcement of any Security Interest over the secured property;
 - (ii) receive a statement of account under section 132(3) (d) and 132(4) of the PPSA if OX Group disposes of any of the secured property following repossession of that secured property; and
 - (iii) receive a copy of, or notice of, any verification statement confirming registration of a financing statement or a financing change statement relating to any Security Interest under, or provided for by, this Agreement.
- 11.8 Except if section 275(7) of the PPSA applies, each party to this Agreement agrees not to disclose any information of the kind referred to in section 275(1) of the PPSA that is not publicly available.



OX Group International Pty Ltd (OX Group) warrants that all products supplied by it and purchased by you from Authorised OX Group Dealers throughout Australia are free of defects except for those products listed under Warranty Exclusions.

Warranty Claims

If you consider that any product supplied by OX Group is defective, you can lodge a claim under this Warranty and any apparent fault will be rectified free of charge by OX Group or an OX Group Authorised Service Dealer within the Warranty Period, which is effective from the date of purchase provided that you meet the following conditions;

- You must produce the original invoice/receipt or other proof of purchase document disclosing the purchase date.
- All costs of installation, cartage, freight, travelling expenses, hiring tools and insurance are paid by the customer.
- The product, being precision equipment, has not been misused, adjusted or serviced by any person other than an OX Group Authorised Service Dealer.
- The equipment has been installed correctly and is used in accordance with the OX Group instructions supplied with the product.

OX Group provides this warranty in addition to all other rights and remedies that you may have under law in relation to the products to which this warranty relates.

Our goods come with guarantees that cannot be excluded under the Australian Consumer Law. You are entitled to a replacement or refund for a major failure and for compensation for any other reasonably foreseeable loss or damage. You are also entitled to have the goods repaired or replaced if the goods fail to be of acceptable quality and the failure does not amount to a major failure.

Notwithstanding the proceeding clause, OX Group's liability in respect of a breach of a consumer guarantee or any warranty made under these Conditions of Warranty for any products not of a kind ordinarily acquired for personal, domestic or household use is limited, to the extent permissible by law and at the option of OX Group to:

1. Replacing the products or the supply of equivalent products;
2. The repair of the products;
3. The payment of the cost of replacing the products or of acquiring equivalent products; or
4. The payment of the cost of having the products repaired.

To the extent permitted by law, all other warranties whether implied or otherwise, not set out in these Conditions of Warranty are excluded and OX Group is not liable in contract, tort (including, without limitation, negligence or breach of statutory duty) or otherwise to compensate the customer for:

1. Any increased cost or expenses;
2. Any loss of profit, revenue, business, contracts or anticipated savings;
3. Any loss or expense resulting from a claim by a third party; or
4. Any special, indirect or consequential loss or damage of any nature whatsoever.

If you wish to make a claim under this Warranty, you should:

- Contact Ph: +612 8845 6600;
- Visit your nearest Authorised OX Group Dealer;
- Visit OX Group website for details: www.oxtools.com

These conditions may only be varied with the written approval of the directors of OX Group International.

Warranty Period

Product Type	Warranty Period
Diamond Tools	12 Months
Hand Tools	12 Months
Access Equipment	12 Months
Safety Equipment	12 Months
Construction Machinery	12 Months

Warranty Exclusions

This section identifies what is excluded under this Warranty.

This Warranty does not cover damage caused by:

- Misusing, overloading or abusing the OX product,
- Operating the product in a manner that is not in accordance with the OX Group instructions supplied with the product (the "Instruction Manual"),
- Failing to clean the product in accordance with the instructions for correct and regular cleaning as set out in the Instruction Manual,
- Not carrying out periodic maintenance,
- Neglecting or otherwise failing to maintain the product in accordance with the instructions for maintenance of the product including regular tune-ups, lubrication etc...,
- Using incorrect voltage or non-authorized electrical connections with the product,
- Installing the product incorrectly,

- Using non authorised/non-standard parts, non-genuine OX Group parts in connection with the product,
- Repairing or carrying out any work on the product by someone other than an Authorised OX Group Service Dealer,
- Causing a double burnout - field and armature burnout,
- Operating the product with any guard, shield or line cutting knife removed, repositioned, or that is incomplete or damaged,
- Using or operating the product with any evidence of partial failure of product or damage being present,
- Tampering with the product in any way other than in accordance with the manual,
- Not having taken reasonable steps to prevent the damage or failure from occurring to the product,
- Storing the product inconsistently with manufacturer's recommendations or where the product is exposed to corrosive substances such as fertilisers, grass and plant residue including palm tree sap, bore water and other detrimental environmental exposure,
- Making mechanical adjustments that are inconsistent with the Manual- including, chains, bars, engine tuning etc...,
- Operating the product with incorrect fuel to oil ratio,
- Having made improper adjustments of ignition timing or the carburettor,
- Using the product with clogged or removed filters (i.e. fuel filter, oil filter, air filter),
- Using incorrect chain and bar oil/lubricant for the oil pump

In addition to the above, this Warranty DOES NOT cover the following:

- Products purchased:
 - Outside of Australia,
 - from a non - Authorised OX Group Dealer (such as purchases from unauthorised retailers and purchases over the internet, from local/ international sellers or sites such as Ebay and Amazon),
 - at an auction, or
 - from a private seller.
- Accidental damage or damage caused by an extra ordinary event or circumstance beyond your or anyone else's control including damage caused by:
 - environmental factors,
 - natural discolouration of material due to ultraviolet light,
 - crushing, impact with hard surface or damage caused in the transit of the product, foreign material, or exposure of the product to excessive heat or cold or to solvents, or water entry into the product,
 - abnormal product performance caused by any ancillary equipment interference or other external factors,
- Damage or failure that occurs for a reason or reasons that were already disclosed to you (in writing or otherwise), prior to your purchase of the product,
- Damage or defects to the product that ought reasonably to have been revealed to you by an examination of the product, where you conducted such an examination before acquiring the product,
- Normal wear and tear due to the course of normal use,
- Freight costs associated transporting the product between you, the place of purchase, the Authorised OX Group Dealer and OX Group for the purposes of making a claim pursuant to this Warranty or otherwise,
- Repairs that are required by you to be made to the product which are simply due to a clogged or restricted exhaust system, carbon deposits in exhaust ports, piston crown or combustion chamber or periodic decarbonising,
- Products with serial number altered or removed,
- Refurbished, ex display or factory second products,
- Consumable items supplied with the product or that are a part of the product,
- Service parts,
- Accessories, that for the avoidance of doubt include but are not limited to the following: those included with the product at the time the product was purchased by you including cases & site bags, brushes, chucks, cord sets, bulbs, LED's & lamps, driver & drill bits, blades, driver blades, o - rings, switches & triggers, power tool attachments, blades and cutters, spark plugs, carburettor kits, filters, bars & chains, cutting equipment, recoil springs, rope, belts, measuring devices, air (pneumatic) fittings, nose caps, gaskets, fuel hoses,
- The product coming into contact with sand, water, rust, corrosion, fire, vermin and insect infestation, power outages or surges or inadequate voltage or current.

If the product you are using has been rented or leased by you, and you consider a claim might be made under this Warranty, you should refer the matter to the rental or leasing company immediately and they will handle the matter.

This Warranty does not cover service costs in replacing and maintaining consumable parts and accessories that have ceased working through normal wear and tear such as, but not limited to: drill heads, blades, cutters and other parts classifiable as a consumable part or accessory.

OX Group International Pty. Ltd.
ABN 41 151 919 569
PO Box 1875, North Sydney NSW 2059
(612) 8845 6600
www.oxtools.com.au

NOTES

A series of horizontal dotted lines for writing notes.



Safety

Safety is not something that is taken lightly at OX. When we design and build our tools the safety of the operator and safety of the tool is always the most important factor that is well thought-out during the whole process.

Safety when using OX tools is of paramount importance. Choosing OX tools is a responsible decision as all OX products are supplied with safety instructions. Ultimately safety comes down to the operator which is why instructions need to be read and adhered to. It is also important to ensure the correct safety clothing is worn whilst working on a construction site.

Environmental

OX Group is committed to managing environmental impact as an integral part of our operations. In particular, it is our policy to assure the environmental integrity of our processes and facilities at all times. We will do so by adhering to the following principles:

We employ management systems and procedures specifically designed to minimise the use of hazardous materials, energy and other natural resources, to minimise the generation of waste and to enable recycling and reuse of materials.

We continually seek opportunities to improve our environmental performance by establishing objectives and targets, measuring progress, and reporting our results; including but not limited to energy, water, paper and fuel consumption and vehicle miles travelled.

We promote participation and communicate our commitment to responsible environmental management by promoting environmental responsibility among our employees; by providing the necessary training and support to enable them to implement this policy; by informing suppliers of our environmental policy and encouraging them to adopt effective environmental management practices; and by soliciting input from our employees, suppliers, customers and board members in meeting our environmental goals.



*It looks good,
it's tough... it's **OX***

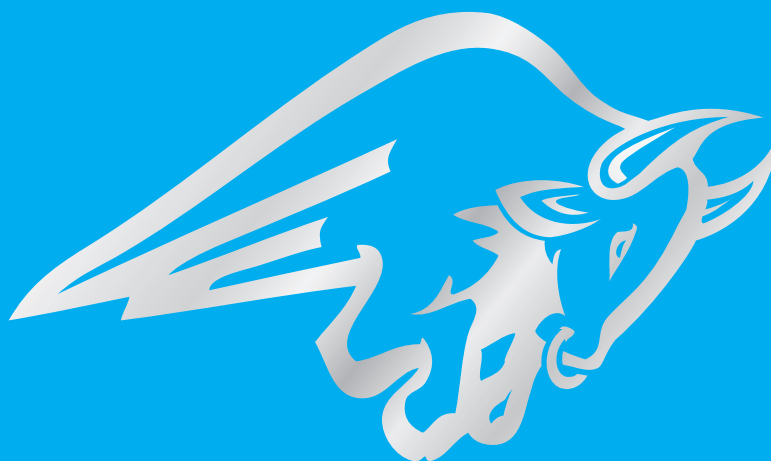

OX GROUP
INTERNATIONAL

For more information, visit: www.oxtools.com

OX Group International

PO Box 1875, North Sydney NSW 2060 AUSTRALIA

Tel: 02 8845 6600 | Fax: 02 8845 6699 | Email: sales@oxgroup.com.au

Subject to availability and OX Group International terms and conditions of sale.

2016 E & OE. © OX Group International